

 HALOGEN FREE  FIRE RESISTANT

BEVESTIGINGSMATERIAAL MATERIEL DE FIXATION

CATALOGUS
CATALOGUE

2025
01

GeV



SINDS | DEPUIS 1985

WIJ BEVESTIGEN UW TOEKOMST
UNE ATTACHE POUR VOTRE AVENIR

PVC BUIZEN EN TOEBEHOREN TUBES PVC ET ACCESSOIRES

Buizen HALOGEN FREE- PC

Tubes HALOGEN FREE - PC



BESTELNUMMER N° DE COMMANDE	∅	LENGTE LONGUEUR	
VD16 LLH	16 mm	3m	111/5550 m
VD20 LLH	20 mm	3m	111/5550 m
VD20 LLHBLACK	20 mm*	3m	111/5550 m
VD25 LLH	25 mm	3m	57/5130 m
VD25 LLHBLACK	25 mm	3m	57/5130 m
VD32 LLH	32 mm	3m	57/3192m

Light Load (2442) : LLH

Lengte / Longueur: 3m

RAL 7035 / *Black RAL 9005

PC = polycarbonaat/polycarbonate



Buizen HALOGEN FREE - PC

Tubes HALOGEN FREE - PC



BESTELNUMMER N° DE COMMANDE	∅	
VD16 MLH	16 mm	111/5550 m
VD20 MLH	20 mm	111/5550 m

Medium Load (3442) : MLH

PC = polycarbonaat/polycarbonate

Lengte / Longueur: 3m - RAL 7035

Light Load (320 newton)



Buizen HALOGEN FREE - PC

Tubes HALOGEN FREE - PC



BESTELNUMMER N° DE COMMANDE	∅	
VD16 FLH	16 mm	111/5550 m
VD20 FLH	20 mm	111/5550 m
VD25 LH	25 mm	57/5130 m
VD32 LH	32 mm	57/3192 m
VD40 LH	40 mm	30 m

Heavy Load (4442) : FLH/LH

Lengte / Longueur: 3m

RAL 7035

PC = polycarbonaat/polycarbonate



PVC BUIZEN EN TOEBEHOREN TUBES PVC ET ACCESSOIRES

Buizen HALOGEN FREE - PC

Tubes HALOGEN FREE - PC



BESTELNUMMER N° DE COMMANDE	∅	
VD50 LH	50 mm	15 m
VD63 LH	63 mm	3 m

Heavy Load (4442) : FLH/LH

Lengte / Longueur: 3m

RAL 7035

PC = polycarbonaat/polycarbonate



Buizen HALOGEN FREE PP met mof Light Load

Tubes HALOGEN FREE PP avec manchon Light Load



BESTELNUMMER N° DE COMMANDE	∅	
VD20HFPPMOF	20 mm	102/5100 m
VD25HPPPMOF	25 mm	75/3750 m

Light Grey = RAL 7035

PP= polypropylène/polypropyleen

Light Load (320 newton)



Buis halfzacht, met trekdraad

Tube semi rigide, avec tire-fil



BESTELNUMMER N° DE COMMANDE	∅	
ERFE20G	20 mm	100 m
ERFE25G	25 mm	50 m



Ribbenbuis

Flex



BESTELNUMMER N° DE COMMANDE	∅	
ECICTA20HFT	20 mm	100 m
ECICTA25HFT	25 mm	50 m
ECICTA20HF	20 mm*	100 m

Met trekdraad / Avec tire-fil

Zolang de voorraad strekt / jusqu'à épuisement du stock



PVC BUIZEN EN TOEBEHOREN TUBES PVC ET ACCESSOIRES

Moffen voor rechte PVC buis

Manchons pour conduite rigide en PVC



BESTELNUMMER N° DE COMMANDE	∅	RAL	
U407	16 mm	RAL 7035	100/2500
U408	20 mm	RAL 7035	100/1600
U409	25 mm	RAL 7035	25/1150
U410	32 mm	RAL 7035	25/600
U411	40 mm	RAL 7035	25
U412	50 mm	RAL 7035	5
U407 R	16 mm	RAL 7037	100/2500
U408 R	20 mm	RAL 7037	100/1600
U409 R	25 mm	RAL 7037	25/1150
U410 R	32 mm	RAL 7037	25/600
U411 R	40 mm	RAL 7037	25
U412 R	50 mm	RAL 7037	5
U413R	63 mm	RAL 7037	5

Light Grey = RAL 7035

R = Dark Grey = RAL 7037



Bochten 90° voor rechte PVC buis

Coudes 90° pour conduite rigide en PVC



BESTELNUMMER N° DE COMMANDE	∅	RAL	
C16VD	16 mm	RAL 7035	50/2000
C20VD	20 mm	RAL 7035	50/1000
C25VD	25 mm	RAL 7035	20/500
C32VD	32 mm	RAL 7035	5
C40VD	40 mm	RAL 7035	5
C50VD	50 mm	RAL 7035	3
C16VD R	16 mm	RAL 7037	50/2000
C20VD R	20 mm	RAL 7037	50/1000
C25VD R	25 mm	RAL 7037	20/500
C32VD R	32 mm	RAL 7037	5
C40VD R	40 mm	RAL 7037	5
C50VD R	50 mm	RAL 7037	3

Light Grey = RAL 7035

R = Dark Grey = RAL 7037

Black = RAL 9005



PVC BUIZEN EN TOEBEHOREN TUBES PVC ET ACCESSOIRES

Bochten 90° voor rechte PVC buis

Coudes 90° pour conduite rigide en PVC



Eindtullen voor rechte PVC buis

Embouts pour conduite rigide en PVC



Invoertule M20

Entrées tube M20



BESTELNUMMER N° DE COMMANDE	∅	RAL	
C25VDLHBLACK	25 mm	RAL 9005	5

Light Grey = RAL 7035

R = Dark Grey = RAL 7037

Black = RAL 9005



BESTELNUMMER N° DE COMMANDE	∅	RAL	
EC16	16 mm	RAL 7035	100/7000
EC20	20 mm	RAL 7035	100/5500
EC25	25 mm	RAL 7035	50/2500
EC16 R	16 mm	RAL 7037	100/7000
EC20 R	20 mm	RAL 7037	100/5500
EC25 R	25 mm	RAL 7037	50/2500

Light Grey = RAL 7035

R = Dark Grey = RAL 7037



BESTELNUMMER N° DE COMMANDE	∅	
MIBR1620	16 & 20 mm	50/2000

Light Grey = RAL 7035



PVC - LSOH PVC - LSOH

Kabeldozen met uitbrekbare ingangen voor wartels

Boîtes de dérivation avec entrées pré-imprimées



BESTELNUMMER N° DE COMMANDE	Ingangen Entrées	∅	Afm. Dim.	
220A	7	PG 16	80x80x50	10
220AM	7	20 mm	80x80x50	10

220A : Pg-maten / Mesures Pg

220AM : Metrische maten / Mesures métriques

IP 54 Druksluiting / Serrage à pression



Kabeldozen met uitbrekbare ingangen

Boîtes de dérivation avec entrées pré-imprimées



BESTELNUMMER N° DE COMMANDE	Ingangen Entrées	∅	Afm. Dim.	
222A	6	PG 16	100x100x55	5
223A	10	PG 16	175x110x66	2
223ATA	10	PG 16	175x110x83	2
224A	10	PG 29	220x170x120	1
222AM	6	20 mm	100x100x55	5
223AM	10	20 mm	175x110x66	2
223ATAM	10	20 mm	175x110x83	2
224AM	10	25 mm	220x170x120	1

222A à 224A : Pg-maten / Mesures Pg

222AM à 224AM : Metrische maten / Mesures métriques

Schroefsluiting / Serrage à vis 3/4"

IP 65



BOX LINE Kabeldoos met metrische schroefingangen

BOX LINE Boîte de dérivation avec filetage métrique

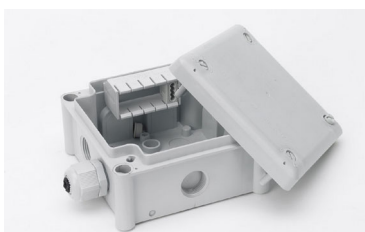

BESTELNUMMER N° DE COMMANDE	Ingangen Entrées	∅	Afm. Dim.	
J100S	7	M20	102²x56 mm	90
J100SC	7	M20	102²x56 mm	90

inclusief connector 3-fasen+n+t

inclus barrette 3-phases+n+t

IP 66



PVC - LSOH PVC - LSOH

BOX LINE Kabeldozen met nippel

BOX LINE Boîtes de dérivation avec entrées étanches



BESTELNUMMER N° DE COMMANDE	Ingangen Entrées	∅	Afm. Dim.	
J80B	8	M25	83²x50mm	1
J100B	8	M25	102²x56mm	1
J160B	8	M25	116²x70mm	1
J200B	8	M32	216x166x90n	1

IP 66



BOX LINE Kabeldozen gesloten

BOX LINE Boîtes de dérivation fermées



BESTELNUMMER N° DE COMMANDE	Ingangen Entrées	∅	Afm. Dim.	
J80L	8	M25	83 x 83 x 50 mm	1
J100L	8	M25	102 x 102 x 56mm	1
J160L	8	M25	166 x 116 x 70 mm	1
J200L	8	M32	216x166x90n	1

IP 66



Kabeldozen met nippels

Boîtes de dérivation avec entrées étanches



BESTELNUMMER N° DE COMMANDE	Ingangen Entrées	∅	Afm. Dim.	
219B	4*	PG21	45 x ∅80 mm	8
220B	7*	20mm	80 x 80 x 50 mm	10
222B	6**	Pg21	100 x 100 x 55 mm	5
223B	10**	Pg21	175 x 110 x 66 mm	2
223BTA	10**	Pg21	175 x 110 x 83 mm	2
224B	10**	Pg29	220 x 170 x 120 mm	1
226B	10**	Pg29	220 x 170 x 120 mm	1

*Druksluiting / Serrage à pression

**Schroefsluiting 3/4" / Serrage à vis 3/4"

IP 54



PVC - LSOH PVC - LSOH

Nippels

Embouts à gradin



BESTELNUMMER N° DE COMMANDE	Afm. Dim.	
MIB16	3,5-20 mm	50
MIB21	3,5-23,5 mm	50
MIB29	3,5-32 mm	50



Groot formaat Grands formats

Kabeldozen gesloten

Boîtes de dérivation fermées



BESTELNUMMER N° DE COMMANDE	Afm. Dim.	
242MF	330x280x175	1



Kabeldozen volledig gesloten met transparant deksel

Boîtes de dérivation fermées avec couvercle transparent



BESTELNUMMER N° DE COMMANDE	Afm. Dim.
223LTATR	175x110x83
224LTR	220x170x120

Schroefsluiting 3/4" / Serrage à vis 3/4"



Thermoplastisch Thermoplastique

Kabeldozen

Boîtes de dérivation



BESTELNUMMER N° DE COMMANDE	Ingangen Entrées	∅	Afm. Dim.	
FE25	10	1,5-4mm	89x43x37	10/150
FE7	7	1,5-4mm	75x75x37	10/300
FE12	12	1,5-4mm	85x85x37	10/150
FE15	12	1,5-4mm	100x100x37	10/128



Met soupele ingang Avec membrane

Ronde Kabeldoos met soupele ingang

Boîte ronde de dérivation avec membrane



BESTELNUMMER N° DE COMMANDE	Afm. Dim.	KLEUR	COULEUR	
M001CS	ø 65x40 mm	Wit	Blanc	1
M002CS	ø 80x40 mm	Wit	Blanc	1
M002CSN	ø 80x40 mm	Zwart	Noir	1



Kabeldoos met soupele ingang

Boîte de dérivation avec membrane



BESTELNUMMER N° DE COMMANDE	Afm. Dim.	KLEUR	COULEUR	
M003CS	80x80x40 mm	Wit	Blanc	1
M005CS	94x94x50 mm	Wit	Blanc	1
M003CSN	80x80x40 mm	Zwart	Noir	1



Kabeldozen PH-4A.1

Boîtes de dérivation IP65



BESTELNUMMER N° DE COMMANDE	Normes	Afm. Dim.	
28.41	IP65	248x198x96	1
28.51	IP65	348x228x142	1
28.61	IP65	400x262x140	1



Kabeldozen met nippels PH-4A.3

Boîtes de dérivation avec entrées étanches PH-4A.3

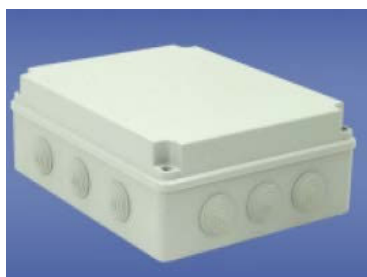

BESTELNUMMER N° DE COMMANDE	Specificiteit Spécificités	Normes	Afm. Dim.	
28.43		IP65	248x198x96	1
28.43-PLEXI	*4		*248x198x96	1

*Met Plexi deksel - Op aanvraag

* Avec couvercle en Plexi - sur demande



Met soupele ingang Avec membrane

Kabeldozen met nippels PH-5A.3

Boîtes de dérivation avec entrées étanches PH-5A.3



BESTELNUMMER N° DE COMMANDE	Normes	Afm. Dim.	
28.53	IP65	348x228x142	1



INBOUWDOZEN BOITES D'ENCASTREMENT

Hollewanddozen

Boîtiers pour mur creux



BESTELNUMMER N° DE COMMANDE	MOD.	∅	Afm. Dim.	
424	1	68 mm	45 mm	10/310
426	1	68 mm	61 mm	10/240
428	2	68 mm	45 mm	5/130
429	3	68 mm	45 mm	5/90



Hollewanddoos vuurvast

Boîtier pour mur creux résistant au feu

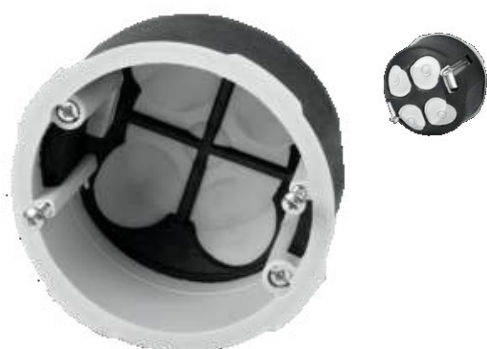

BESTELNUMMER N° DE COMMANDE	∅	Afm. Dim.	
KPZ1PO	68 mm	47 mm	1

PP (halogen-free, pb-free) + foaming material
temperature resistance: -5 - +60 °C (activation of foaming material from 200 °C)

EN 1363-1:2013

EI 15 - EI 120



Hollewanddoos harde uitvoering - Winddicht - Halogen free

Boîtier rigide pour mur creux - Etanche - Sans Halogène

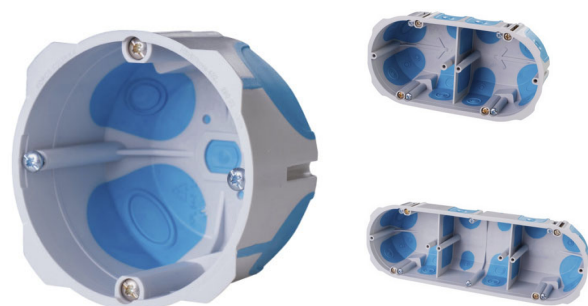

BESTELNUMMER N° DE COMMANDE	MOD.	Afm. Dim.	
KP64-50LDHF	1	1x50x68 mm	1
KP64-60LDHF	1	1x60x68 mm	1
KP64-50-2LDHF	2	2x50x68 mm	1
KP64-50-3LDHF	3	3x50x68 mm	1



Universele inbouwdozen zonder Vijs

Boîtiers d'encastrement universel sans Vis



BESTELNUMMER N° DE COMMANDE	MOD.	Afm. Dim.	
430	1	60x60x50mm	10/200
431	1	60x60x65mm	10/200



INBOUWDOZEN BOITES D'ENCASTREMENT

Universele inbouwdozen met Vijs

Boîtiers d'encastrement universel avec Vis



BESTELNUMMER N° DE COMMANDE	MOD.	Afm. Dim.	
430V	1	60x60x50mm	10/200
431V	1	60x60x65mm	10/180



Inbouwdozen

Boîtiers d'encastrement



BESTELNUMMER N° DE COMMANDE	MOD.	Afm. Dim.	
316	1	75x75x42mm	10/100
318	1	75x75x60mm	10/100



VERDEELKASTEN COFFRETS DE DISTRIBUTION

Verdeelkasten opbouw Type C / IP 40 In-63A

Coffrets de distribution en saillie Type C / IP 40 In-63A



BESTELNUMMER N° DE COMMANDE	MOD.	Afm. Dim.	
N4-C	1 x 4	232x139x99 mm	1 / 5
N8-C	1 x 8	215x236x112 mm	1 / 5
N12-C	1 x 12	287x236x112 mm	1 / 5
N18-C	1 x 18	396x236x112 mm	1 / 5
N24-C	2 x 12	287x361x112 mm	1 / 5
N36-C	3 x 12	287x485x112 mm	1 / 5
N2x18-C	2 x 18	396x361x112 mm	1 / 5
N3x18-C	3 x 18	396x526x112 mm	1 / 5
N48-C	4 x 12	287x651x112 mm	1 / 5
N4x18-C	4 x 18	651x396x112 mm	1 / 5

Din rail en aardingsrail inclusief en geïnstalleerd
Rail Din et barrette de terre pré-installé



Verdeelkasten inbouw Type C / IP 40 In-63A

Coffrets de distribution à encastrer Type C / IP 40 In-63A



BESTELNUMMER N° DE COMMANDE	MOD.	Afm. Dim.	
U8-C	1 x 8	211x232x99 mm	1/5
U12-C	1 x 12	283x232x106 mm	1/5
U18-C	1x 18	392x232x106 mm	1/5
U24-C	2 x 12	283x357x106 mm	1/5
U36-C	3 x 12	283x482x106 mm	1/5
U2x18-C	2 x 18	392x357x106 mm	1/5
U3x18-C	3 x18	392x522x106 mm	1/5
U4-C	1 x 4	211 x 232 x 99 mm	1/5

Din rail en aardingsrail inclusief en geïnstalleerd
Rail Din et barrette de terre pré-installé



VERDEELKASTEN COFFRETS DE DISTRIBUTION

Slot voor verdeelkasten

Serrure pour coffrets de distribution



BESTELNUMMER N° DE COMMANDE	Specificiteit Spécificités
LOCKCM	Serie C

Verdeelkasten opbouw Type D / IP 65 In-63A

Coffrets de distribution en saillie Type D / IP 65 In-63A



BESTELNUMMER N° DE COMMANDE	MOD.	Afm. Dim.	
N4-D	1 x 4	127x200x120 mm	1/5
N6-D	1 x 6	165x201x120 mm	1/5
N8-D	1 x 8	200x200x120 mm	1/5
N12-D	1 x 12	318x258x142 mm	1/5
N18-D	1 x 18		1/5
N24-D	2 x 12	318x383x142 mm	1/5
N36-D	3 x 12	318x507x142 mm	1/5
N48-D	4 X 12		1/5

Din rail en aardingsrail inclusief en geïnstalleerd
Rail Din et barrette de terre pré-installé



Vijs voor verdeelkas

Vis pour coffret de distribution



Vijs voor serie C en D
Vis pour serie C et D



VERDEELKASTEN COFFRETS DE DISTRIBUTION

Slot voor verdeelkasten

Serrure pour coffrets de distribution



BESTELNUMMER N° DE COMMANDE	Specificiteit Spécificités
LOCKDM	Serie D

Installatieset voor verdeelkast

Set d'installation pour coffret de distribution



BESTELNUMMER N° DE COMMANDE	
NSET-C-D	1

Installatie/vervangset voor serie C en D
Set d'installation/remplacement pour serie C et D

Verdeelkasten opbouw Type NEO / IP 65 In-100A

Coffrets de distribution en saillie Type NEO / IP 65 In-100A



BESTELNUMMER N° DE COMMANDE	MOD.	Afm. Dim.	
RH18S	1 x 18	435x260x138 mm	1
RH36/2S	2 x 18	435x420x138 mm	1
RH54/3S	3 x 18	435x580x138 mm	1
RH72/4S	4 x 18	435x780x138 mm	1

Din rail en aardingsrail inclusief en geïnstalleerd
Rail Din et barrette de terre pré₁ installé



Slot voor verdeelkasten

Serrure pour coffrets de distribution



BESTELNUMMER N° DE COMMANDE	Specificiteit Spécificités
36.81	Serie NEO

VERDEELKASTEN COFFRETS DE DISTRIBUTION

Verdeelkasten opbouw IP 55 Incl. din rail

Coffrets de distribution en saillie IP 55



BESTELNUMMER N° DE COMMANDE	Ingangen Entrées	MOD.	Afm. Dim.	
250-5AM	6xM20+4xM	4 + 1	95x162x122 mm	1/40
250-9AM	6xM20+4xM	8 + 1	98x162x202 mm	1/24
250-11AM	10xM25	10 + 1	109x232x182 mm	1/17
250-9B	10 x PG21 met Nippels	8+1	98 X 162 X 202 mm	1/24



Afdekplaatjes voor MCB - Wit - 12 modulen

Couvercles universels pour MCB - Blanc - 12 modules



BESTELNUMMER N° DE COMMANDE	Afm. Dim.	
273MF	200x52x8 mm	10



Stopcontact voor borden - DIN Rail 35 mm

Prise de courant pour tableau - DIN Rail 35mm



BESTELNUMMER N° DE COMMANDE	Stroomsterkte Ampérage	SPANNING TENSION	
C500	16A	230V	1/5

VDE -EN 50 0 22



VERDEELKASTEN COFFRETS DE DISTRIBUTION

Kabeldoorvoer Quickseal M32

Cable transit Quickseal M32



BESTELNUMMER N° DE COMMANDE	Afm. Dim.	
TPQSM32	M32	10/100



VLOERDOZEN BOÏTE POUR SOL

Vloerdozen voor toebehoren 45 x 45

Boîtes sol pour accessoires 45 x 45

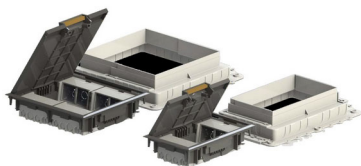

BESTELNUMMER N° DE COMMANDE	MOD.	Afm. Dim.
745-4C LG	4	146x250x56 mm
745-8C LG	8	250x250x56 mm
745-CRF748	4 - 8	*

* Inlegstuk Voor Beton Voor Vloerdozen 4 En 8 Modules

* Piece d'Encastrement Pour Beton Pour Les Boites Sol 4 Et 8 Modules



Kader voor vloerdoos voor gebruik in beton / chape

Cadre pour boîte sol pour chape de béton



BESTELNUMMER N° DE COMMANDE
CFR748



Dubbele afdekplaat + 2 stekkers RJ45 CAT 6

Plaque double + 2 connecteurs RJ45 CAT6



BESTELNUMMER N° DE COMMANDE	Specificiteit Spécificités
745-LAN	CAT 6



SNELVERBINDERS CONNECTEURS RAPIDES

Universele steekklemmen

Raccords universels



BESTELNUMMER N° DE COMMANDE	∅	
SDKF2TR-AN	0,2 - 2,5mm ²	100 / 2000
SDKF3TR-AN	0,2 - 2,5mm ²	75 / 1500
SDKF5TR-AN	0,2 - 2,5mm ²	50 / 1000



Steekklemmen voor harde draad

Raccords pour fil rigide



BESTELNUMMER N° DE COMMANDE	∅	
SDK3	0,5 - 2,5mm ²	100 / 2000
SDK5	0,5 - 2,5mm ²	100 / 2000
SDK8	0,5 - 2,5mm ²	100 / 1000



Lusterklemmen

Raccords lustre

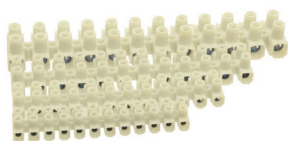

BESTELNUMMER N° DE COMMANDE	∅	
50704	2,5 - 4 mm ²	10/500
50706	6 mm ²	10/250
50710	10 mm ²	10/250
50716	16 mm ²	10/100
50725	25 mm ²	10/50

24A , 450V, CE, HF, PP
Wit / Blanc



SNELVERBINDERS CONNECTEURS RAPIDES

Klemstenen

Barrettes de connection



BESTELNUMMER N° DE COMMANDE	Specificiteit Spécificités	∅ BINNEN ∅ NTERNE	
397-5	*1	1,5 - 4mm ²	20
397-3A	*1	1,5 - 4mm ²	20
398-5	*2	2,5mm ²	20
399-5	*3	4 - 16mm ²	10

*1 Voor / Pour : 220A / 220B / 222A/ 222B / 222L

*2 Voor / Pour : FE25 / FE7 / FE12

*3 Voor / Pour : BOX LINE



BLACK & WHITE BLACK & WHITE

Eindstuk
Embout



BESTELNUMMER N° DE COMMANDE	Afm. Dim.	
EC20BLACK	20 mm	100 / 5500
EC20WHITE	20 mm	100 / 5500
EC25BLACK	25 mm	50 / 2500

Black = RAL 9005
White = RAL 9003



PVC Stop
Bouchon PVC



BESTELNUMMER N° DE COMMANDE	Afm. Dim.	
907M20 Black	20 mm	50 / 2000

Black = RAL 9005



Buisinvoer
Entrée tube



BESTELNUMMER N° DE COMMANDE	Afm. Dim.	
MIBR1620 Black	16/20 mm	50 / 2000
MIBR1620 White	16/20 mm	50 / 2000

White = RAL 9003
Black = RAL 9005



BLACK & WHITE BLACK & WHITE

Mof

Manchon



BESTELNUMMER N° DE COMMANDE	Afm. Dim.	
U408 White	20 mm	50 / 1600
U408 Black	20 mm	100 / 1600
U409 Black	25 mm	25 / 1125

White = RAL 9003
Black = RAL 9005



Aaneenschuifbare klem SUPER T B&W

Attache à juxtaposer SUPER T B&W



BESTELNUMMER N° DE COMMANDE	∅	
ST16BLACK	16 mm	100/3000
ST20BLACK	20 mm	100/3000
ST25BLACK	25 mm	100/3000
ST32BLACK	32 mm	100/3000

M6 Polyamide
Kleur : Zwart
Couleur : Noir
RAL9005



Deksel voor SUPER T B&W

Couvercle pour SUPER T B&W



BESTELNUMMER N° DE COMMANDE	∅	
STC16BLACK	16 mm	100/9600
STC20BLACK	20 mm	100/9600
STC25BLACK	25 mm	100/9600
STC32BLACK	32 mm	100/9600

M6 Polyamide
Kleur : Zwart
Couleur : Noir
RAL9005



BLACK & WHITE BLACK & WHITE

Veerklem Black & White

Attache ressort Black & White



BESTELNUMMER N° DE COMMANDE	Afm. Dim.	
204WHITE	20 mm	100 / 3000
204BLACK	20 mm	100 / 3000
208BLACK	25 mm	50 / 1500
209BLACK	32 mm	50

White = RAL 9003
Black = RAL 9005



Aaneenschuifbare drukklemmen

Attaches à pression à juxtaposer



BESTELNUMMER N° DE COMMANDE	Afm. Dim.	
2036BLACK	12 - 20 mm	50 / 1500
2037BLACK	16 - 26 mm	50 / 1500

Black = RAL 9005



Nagelclips - Platte Kabel - Wit

Attaches à clouer - câble plat - Blanc



BESTELNUMMER N° DE COMMANDE	∅	
702-2W	2 x 1,5	100



BLACK & WHITE BLACK & WHITE

Wartel

Presse-étoupe



BESTELNUMMER N° DE COMMANDE	Afm. Dim.	
BM20 White	20 mm	50 / 2000
BM20 Black	20 mm	50 / 2000

White = RAL 9003
Black = RAL 9005



Boxline kabeldoos schroefingangen M20

Boxline boîte de dérivation filetage M20



BESTELNUMMER N° DE COMMANDE	Ingangen Entrées	∅	Afm. Dim.	
J100S Black	7	M20	102²x56 mm	1 / 90
J100S White	7	M20	102²x56 mm	1 / 90

White = RAL 9003
Black = RAL 9005



Kabeldoos thermoplast

Boîte de dérivation thermoplastique



BESTELNUMMER N° DE COMMANDE	Ingangen Entrées	Afm. Dim.	
FE25 Black	10	89 x 43 x 37 mm	10 / 150
FE25 White	10	89 x 43 x 37 mm	10 / 150
FE7 Black	7	75x75x37	10/300

Black = RAL 9005
White = RAL 9010
∅ 1,5-4mm



WARTELS PRESSE-ETOUPES

Wartels - Pg reeks

Presse-étoupes - Série Pg



BESTELNUMMER N° DE COMMANDE	∅	
90507	PG7	50
90509	PG9	50 / 3750
90511	PG11	50 / 2700
90513	PG13,5	50 / 2700
90516	PG16	50 / 1850
90521	PG21	20 / 1080
90529	PG29	20 / 440
90536	PG36	10 / 220
90548	PG48	5

Polystyrol

Schokbestendig / Résistant au choc

Wurtring in rubber / Bague d'échanchéité en caoutchouc

Drukrondeel in gegalvaniseerd ijzer / Rondelle de pression en acier galvanisé

IP 65 – 5°C à + 60°C



Wartels met trekcontlasting - Pg reeks

Presse-étoupes à serrage - Série Pg



BESTELNUMMER N° DE COMMANDE	∅	
9707-ORL01	PG7	100
9709-ORL02	PG9	100
9711-ORL03	PG11	100
9713-ORL04	PG13,5	100
9716-ORL05	PG16	50
9721-ORL06	PG21	50
9729-ORL07	PG29	25
9736-ORL08	PG36	10
9748-ORL10	PG48	5

Polyamide met TPE rubber / Bague TPE

IP 68 –30°C à + 80°C



WARTELS PRESSE-ETOUPES

Tegenmoeren - Pg reeks

Contre-écrous - Série Pg



BESTELNUMMER N° DE COMMANDE	∅	
90607	PG7	50
90609	PG9	50
90611	PG11	50
90613	PG13,5	50 / 5600
90616	PG16	50 / 5600
90621	PG21	20 / 2240
90629	PG29	20 / 2240
90636	PG36	10
90648	PG48	10

Polystyrol / Polystyrene
Schokbestendig / Résistant au choc
– 5°C à + 60°C
DIN 46320 - L



Stoppen - Pg reeks

Bouchons - Série Pg



BESTELNUMMER N° DE COMMANDE	∅	
90707	PG7	100
90709	PG9	100
90711	PG11	100
90713	PG13,5	50
90716	PG16	50
90721	PG21	50
90729	PG29	50
90736	PG36	50
90748	PG48	25

Polystyrol / Polystyrene
Schokbestendig / Résistant au choc
– 5°C à + 60°C
DIN 46320 - N



WARTELS PRESSE-ETOUPES

Wartels - Metrische reeks

Presse-étoupes - Série Métrique IP54



BESTELNUMMER N° DE COMMANDE	∅	
905M12-DMRL01	12 mm	50
905M16-DMRL03	16 mm	100
905M20-DMRL04	20 mm	100
905M25-DMRL06	25 mm	50

Polyamide / IP 54 / -30°C / +80°C,
TPV Rubber / Bague TPV, EN60423



Wartels met trekcontlasting - Metrische reeks IP68

Presse-étoupes à serrage - Série Métrique IP68



BESTELNUMMER N° DE COMMANDE	∅	
BM12	12 mm	50 / 2000
BM16	16 mm	50 / 2000
BM20	20 mm	50 / 2000
BM25	25 mm	20 / 800
BM32	32 mm	20 / 600
BM40	40 mm	10 / 300
BM50	50 mm	5 / 200
BM63	63 mm	5 / 120

Met skintop en trekcontlasting
Avec skintop et serrage étendu
Polyamide / IP 68 / -20°C / +125°C



Wartels MULTIHOLE met trekcontlasting - Metrische reeks IP65

Presse-étoupes MULTIHOLE à serrage - Série Métrique IP6

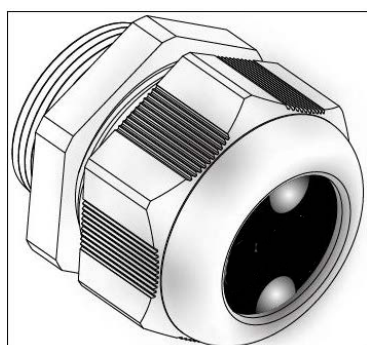

BESTELNUMMER N° DE COMMANDE	Ingangen Entrées	∅
OMRL05A7	2 x 7 mm	M20

IP65, -30°C / +80°C, RAL7035
Andere configuraties op aanvraag
Autres configurations sur demande



WARTELS PRESSE-ETOUPES

Wartels met trekontlasting

Presse-étoupes à serrage - Série Métrique



BESTELNUMMER N° DE COMMANDE	∅	
OMRL03 M16	M16 (5-10 mm)	150 / 2500
OMRL05 M20	M20 (10-14 mm)	150 / 2500
OMRL09 M50	M50	100 / 1600
OMRL10 M63	M63	100 / 1600

Polyamide / IP 68
 -30°C / +80°C,
 TPV Rubber / Bague TPV, EN50262, RAL7035, VDE
 RAL7035
 Einde Reeks/Fin de série



Tegenmoeren - Metrische reeks

Contre-écrous - Série Métrique



BESTELNUMMER N° DE COMMANDE	∅	
PM12	12 mm	50/4800
PM16	16 mm	50/4800
PM20	20 mm	50/4800
PM25	25 mm	20/1920
PM32	32 mm	20/1920
PM40	40 mm	10/960
PM50	50 MM	10/480
PM63	63 MM	5/480

Polyamide
 RAL7035
 - 20°C / +125°C



Tegenmoeren - Metrische reeks

Contre-écrous - Série Métrique



BESTELNUMMER N° DE COMMANDE	∅
OMSL01	12 mm
OMSL02	16 mm
OMSL03	20 mm

Polyamide (30% Glassfiber)
 RAL7035
 - 30°C / +80°C



WARTELS PRESSE-ETOUPES

Tegenmoeren - Metrische reeks

Contre-écrous - Série Métrique



BESTELNUMMER N° DE COMMANDE	∅
OMSL04	25 mm
OMSL05	32 mm
OMSL06	40 mm
OMSL07	50 mm
OMSL08	63 mm

Polyamide (30% Glassfiber)

RAL7035

- 30°C / +80°C



Stoppen - Metrische reeks

Bouchons - Série Métrique



BESTELNUMMER N° DE COMMANDE	∅	
907M12	12 mm	100
907M16	16 mm	100
907M20	20 mm	100
907M25	25 mm	25
907M32	32 mm	20
907M40	40 mm	10
907M50	50 mm	4
907M63	63 mm	4

Polyamide

RAL7035

- 30°C / +80°C



Wurgnippels - Metrische reeks

Raccords à visser - Série Métrique



BESTELNUMMER N° DE COMMANDE	∅	
908M16	16 mm	100
908M20	20 mm	100
908M25	25 mm	100

Polyamide

RAL7035

- 30°C / +80°C



WARTELS PRESSE-ETOUPES

Wurgnippels - Metrische reeks

Raccords à visser - Série Métrique



BESTELNUMMER N° DE COMMANDE	∅	
908M32	32 mm	50
908M40	40 mm	25
908M50	50 mm	10

Polyamide
RAL7035
- 30°C / +80°C



Drukmoeren - Metrische reeks

Boulons de pression - Série Métrique



BESTELNUMMER N° DE COMMANDE	∅	
909M16	16 mm	100
909M20	20 mm	100



Vergrotingen - Metrische reeks

Augmentations - Série Métrique



BESTELNUMMER N° DE COMMANDE	∅ BINNEN ∅ NTERNE	∅	
ME1216	M16	M12	100
ME1620	M20	M16	100
ME2025	M25	M20	100
ME2532	M32	M25	50
ME3240	M40	M32	50

Polystyrol / IP 65 / - 5°C / + 60°C



WARTELS PRESSE-ETOUPES

Verkleiningen - Metrische reeks

Réductions - Série Métrique



BESTELNUMMER N° DE COMMANDE	∅ BINNEN ∅ INTERNE	∅	
MR1612	M12	M16	100
MR2012	M12	M20	100
MR2016	M16	M20	100
MR2512	M12	M25	100
MR2516	M16	M25	100
MR2520	M20	M25	100
MR3212	M12	M32	50
MR3216	M16	M32	50
MR3220	M20	M32	50
MR3225	M25	M32	50
MR4016	M16	M40	50
MR4020	M20	M40	50
MR4025	M25	M40	50
MR4032	M32	M40	50
MR5020	M20	M50	25
MR5025	M25	M50	25
MR5032	M32	M50	25
MR5040	M40	M50	25
MR6325	M25	M63	25
MR6332	M32	M63	25
MR6340	M40	M63	25
MR6350	M50	M63	25



SUPER T SUPER T

Aaneenschuifbare klem SUPER T

Attache à juxtaposer SUPER T



BESTELNUMMER N° DE COMMANDE	ø	KLEUR	
ST16	16 mm	RAL7035	100/3000
ST16R	16 mm	RAL7037	100/3000
ST20	20 mm	RAL7035	100/3000
ST20R	20 mm	RAL7037	100/3000
ST25	25 mm	RAL7035	100/3000
ST25R	25 mm	RAL7037	100/3000
ST32	32 mm	RAL7035	100/3000
ST32R	32 mm	RAL7037	100/3000
ST40	40 mm	RAL7035	50/1500

M6 Polyamide

Kleur : grijs

Couleur : gris

R : RAL7037



Deksel voor SUPER T

Couvercle pour SUPER T



BESTELNUMMER N° DE COMMANDE	Afm. Dim.	KLEUR	
STC16	16 mm	RAL7035	100/9600
STC16R	16 mm	RAL7037	100/9600
STC20	20 mm	RAL7035	100/9600
STC20R	20 mm	RAL7037	100/9600
STC25	25 mm	RAL7035	100/9600
STC25R	25 mm	RAL7037	100/9600
STC32	32 mm	RAL7035	100/9600
STC32R	32 mm	RAL7037	100/9600
STC40	40 mm	RAL7035	50/4800

Kleur : grijs

Couleur : gris

R : RAL7037



SUPER T SUPER T

Plug M6 voor veer- en drukklemmen

Cheville M6 pour attaches ressort et à pression



BESTELNUMMER N° DE COMMANDE	
20436	100

M6 Polyamide
Kleur : grijs
Couleur : gris
3 posities / 3 positions



Plug M6 voor veer- en drukklemmen

Cheville M6 pour attaches ressort et à pression



BESTELNUMMER N° DE COMMANDE	Specificiteit Spécificités	
PST-5	27 mm	100/9600
PST-5R	27 mm	100/9600
PST-7	42 mm	100/9600
PST-7R	42 mm	100/9600

M6 Polyamide
Kleur : grijs
Couleur : gris
R : RAL 7037
1 positie / 1 position



Montageplug M6 voor beton voor klem SUPER T

Cheville de montage M6 pour béton pour SUPER T

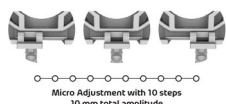

BESTELNUMMER N° DE COMMANDE	Afm. Dim.	
PSTB-4	27 mm	100/9600
PSTB-4R	27 mm	100/9600
PSTB-7	42 mm	100/9600
PSTB-7R	42 mm	100/9600

M6 Polyamide
Kleur : grijs
Couleur : gris
R : RAL 7037
10 posities / 10 positionS



SUPER T SUPER T

Montageplug voor metalen plaat voor klem SUPER T

Cheville de montage pour plaque de métal pour SUPER T

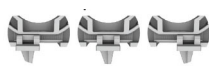

Micro Adjustment with 10 steps
10 mm total amplitude



BESTELNUMMER N° DE COMMANDE	
ST-CLIP	100/14400

Polyamide
Kleur : grijs
Couleur : gris
10 posities / 10 positionS
Ook voor kabelbinders / aussi pour colliers de câblage



Montageplug voor gebruik met siliconen voor klem SUPER T

Cheville de montage pour usage avec sillicon pour SUPER T

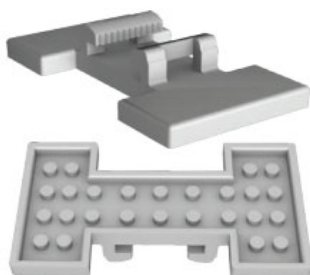

Multiple Positions
Micro Adjustment with 10 steps
10 mm total amplitude



BESTELNUMMER N° DE COMMANDE	
ST-BASE	100/9600

Polyamide
Kleur : grijs
Couleur : gris
10 posities / 10 positionS
Ook voor kabelbinders / aussi pour colliers de câblage



Kabelhouder

Attaches câble

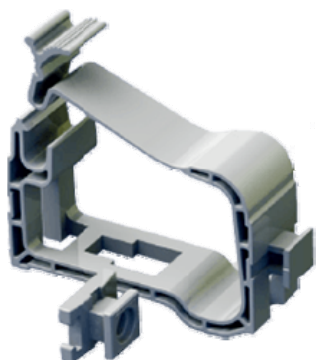

BESTELNUMMER N° DE COMMANDE	Normes	Afm. Dim.
710-15	Max. 10kg	38x69 mm
710-30	Max. 15kg	42x106 mm



VEERKLEMMEN ATTACHES RESSORT

veerklemmen

Attaches ressort



BESTELNUMMER N° DE COMMANDE	∅	
108	50 mm	25 / 600

M6 Polyamide
Kleur : grijs
Couleur : gris



Aaneenschuifbare veerklemmen

Attaches ressort à juxtaposer



BESTELNUMMER N° DE COMMANDE	∅	
211	16 mm	100 / 4000
211R	16 mm	100 / 4000
204	20 mm	100 / 3000
204R	20 mm	100 / 3000
208	25 mm	50 / 1500
208R	25 mm	50 / 1500
209	32 mm	50 / 1500
209R	32 mm	50 / 1500
210	40 mm	25 / 750

M6 Polyamide
Kleur : grijs
Couleur : gris
R : RAL7037



Aaneenschuifbare drukklemmen

Attaches pression à juxtaposer



BESTELNUMMER N° DE COMMANDE	∅	
2035	6 - 13 mm	50 / 3750
2036	12 - 20 mm	50 / 1500
2037	16 - 26 mm	50 / 1500
2038	18 - 30 mm	50 / 1200
2039	27 - 43 mm	25 / 750

M6 Polyamide
Kleur : grijs
Couleur : gris



VEERKLEMMEN ATTACHES RESSORT

Universele klemmen

Attaches universelles



BESTELNUMMER N° DE COMMANDE	∅	
031G	16 - 22 mm	50 / 2700
031T	16 - 22 mm	50 / 2700

Kleur : Grijs of transparant
Couleur : Gris ou transparent



Veerklem met Plug M6

Attache Ressort avec Cheville M6

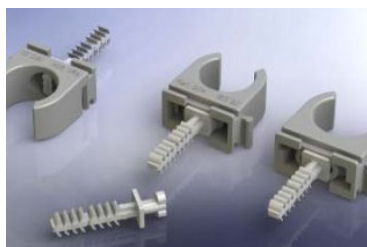

BESTELNUMMER N° DE COMMANDE	∅	
204D	20 mm	50/2000
211D	16 mm	100/4000

M6 Polyamide
Kleur : grijs
Couleur : gris



Drukklem met Plug M6

Attaches pression avec Cheville M6



BESTELNUMMER N° DE COMMANDE	∅	
2036D	12 - 20 mm	50 / 1500
2037D	16 - 24 mm	50 / 1200

M6 Polyamide
Kleur : grijs
Couleur : gris



KLEMMEN ATTACHES

Vorkklemmen

Attaches fourchette



BESTELNUMMER N° DE COMMANDE	∅	
512	10 mm	100/1000
513	12 mm	100/1000
514	13,5 - 15 mm	100/5400
515	14 - 15 mm	100/1000
516	16 - 18 mm	50/2500
517	20 - 22 mm	50/2500
518	22 - 25 mm	50/2700
519	35 mm	30/1080
519BIS	25 - 28 mm	50/500
520	42 mm	20/720

M6 Polyamide
Grijs / gris



Vorkklemmen dubbel

Attaches fourchette double



BESTELNUMMER N° DE COMMANDE	∅	
512-2	10 mm	50/500
513-2	12 mm	50/1000
515-2	14 - 15 mm	50/1000
516-2	16 - 18 mm	25/1350
517-2	20 - 22 mm	25/1350
518-2	25 - 28 mm	20/720

Voor gelijktijdige bevestiging van 2 kabels of buizen
Pour fixation simultane de 2 cables ou tubes

M6 Polyamide
Grijs / gris



KZM kabelzadels

KZM attaches



BESTELNUMMER N° DE COMMANDE	∅	
905	5 - 14 mm	100/4000

Polypropyleen/Polypropylène
Vijs in polystyrol/Vis en polystyrol



KLEMMEN ATTACHES

KZM kabelzadels

KZM attaches



BESTELNUMMER N° DE COMMANDE	∅	
906	6 - 17 mm	50/2000
907	15 - 25 mm	50/1200
908	24 - 34 mm	25/750

Polypropyleen/Polypropylène
Vijs in polystyrol/Vis en polystyrol



KZM kabelzadels dubbel

KZM attaches double



BESTELNUMMER N° DE COMMANDE	∅	
906-2	6 - 17 mm	50/1500

Polypropyleen/Polypropylène
Vijs in polystyrol/Vis en polystyrol



Slagklemmen

Attaches intercalaires



BESTELNUMMER N° DE COMMANDE	∅	
2047	5 - 25 mm	100 / 5400
2048	8 - 38 mm	100 / 3000

Snelle montage voor rail 761 & 2761
Fixation rapide pour rail 761 & 2761



Railklemmen

Attaches pour rail avec vis



BESTELNUMMER N° DE COMMANDE	∅	
2050	7 - 25 mm	100 / 5400
2051	13 - 38 mm	100 / 3000

Voor rail 761 & 2761
Pour rail 761 & 2761



KLEMMEN ATTACHES

Aaneenschuifbare 'Clic' klemmen

Attaches 'Clic' à juxtaposer



BESTELNUMMER N° DE COMMANDE	∅	
701516	15 - 16 mm	50/1350
701920	20 - 22 mm	50/900
702225	25 -28 mm	50/400



SNELMONTAGE FIXATION RAPIDE

Universele nagelclips

Clips à clouer universels



BESTELNUMMER N° DE COMMANDE	∅	
700-02	2,5 - 4 mm	100 /12800
700-05	5 - 7 mm	100 /12800
700-08	8 - 10 mm	100 /9600
700-11	11 - 15 mm	100 /7500
700-16	16 - 19 mm	50 /2000
700-23	23 - 29 mm	50 /250
700-08 Black	8 - 10 mm *	100 /9600

Met slechts 6 types alle maten in voorraad. Kleur: Grijs
Avec seulement 6 types toutes dimensions en stock. Couleur:
Gris

* Black



Nagelclips - maten in mm

Attaches à clouer - mesures en mm



BESTELNUMMER N° DE COMMANDE	∅	KLEUR	COULEUR	
3004-18	4 mm	Grijs	Gris	100 /12800
3005-18	5 mm	Grijs	Gris	100 /12800
3005-18WHITE	5 mm	Wit	Blanc	100
3006-18	6 mm	Grijs	Gris	100 /12800
3006-18WHITE	6 mm	Wit	Blanc	100
3007-18	7 mm	Grijs	Gris	100 /12800
3007-18WHITE	7 mm	Wit	Blanc	100
3008-20	8 mm	Grijs	Gris	100 /12800
3008-20WHITE	8 mm	Wit	Blanc	100
3009-20	9 mm	Grijs	Gris	100 /12800
3009-20WHITE	9 mm	Wit	Blanc	100
3010-35	10 mm	Grijs	Gris	100 /12800
3010-25WHITE	10 mm	Wit	Blanc	100
3011-35	11 mm	Grijs	Gris	100 /12800

De 2 laatste cijfers van het bestelnummer duiden de lengte van de nagel aan.

Les 2 derniers chiffres du n° de commande indiquent la longueur du clou.

WHITE = NIEUWE/NOUVEAU !

GRIJS/GRIS : Tot uitputting van de voorraad./Jusqu'à épuisement du stock.



SNELMONTAGE FIXATION RAPIDE

Nagelclips - maten in mm

Attaches à clouer - mesures en mm



BESTELNUMMER N° DE COMMANDE	∅	KLEUR	COULEUR	
3011-25WHITE	11 mm	Wit	Blanc	100
3012-35	12 mm	Grijs	Gris	50 / 6400
3012-25WHITE	12 mm	Wit	Blanc	100
3014-40	14 mm	Grijs	Gris	50 / 5400
3014-20WHITE	14 mm	Wit	Blanc	50
3014-40WHITE	14 mm	Wit	Blanc	100
3016-40	16 mm	Grijs	Gris	25 / 3250
3016-40WHITE	16 mm	Wit	Blanc	100
3018-40	18 mm	Grijs	Gris	25 / 3200
3018-20WHITE	18 mm	Wit	Blanc	50
3018-40WHITE	18 mm	Wit	Blanc	100
3020-40	20 mm	Grijs	Gris	25 / 3200
3020-40WHITE	20 mm	Wit	Blanc	100

De 2 laatste cijfers van het bestelnummer duiden de lengte van de nagel aan.

Les 2 derniers chiffres du n° de commande indiquent la longueur du clou.

WHITE = NIEUWE/NOUVEAU !

GRIJS/GRIS : Tot uitputting van de voorraad./Jusqu'à épuisement du stock.



Nagelclips - maten in mm

Attaches à clouer - mesures en mm



BESTELNUMMER N° DE COMMANDE	∅ BINNEN ∅ NTERNE	
OL70211	3/4 mm	100 /10000
OL70212	5/6 mm	100 /10000
OL70213	7/8 mm	100 /10000
OL70214	9/10 mm	100 /10000
OL70215	11/12 mm	100 /10000
OL70216	13/14 mm	100 /5000
OL70217	15/16 mm	100 /4000
OL70218	19/20 mm	100 /3000



SNELMONTAGE FIXATION RAPIDE

Nagelclips - Platte Kabel

Attaches à clouer - câble plat



BESTELNUMMER N° DE COMMANDE	∅	COULEUR	
702-0	2 x 0,75		100 /2000
702-0WHITE	2 x 0,75	Wit/Blanc	200
702-1	2 x 1		100 /2000
702-1WHITE	2 x 1	Wit/Blanc	100
702-2	2 x 1,5		100 /1000
702-2WHITE	2 x 1,5	Wit/Blanc	100
702-3	2 x 2,5		100 /1000
702-3WHITE	2 x 2,5	Wit/Blanc	100

WHITE : NIEUWE/NOUVEAU !



Plugclips met nagel

Clips cheville avec clou



BESTELNUMMER N° DE COMMANDE	∅	
300620W	16 - 19 mm	200 / 3200
300720W	16 - 19 mm	100 / 1600



Betonplugclips in PVC Clips cheville en PVC pour béton

Plugclips in PVC - Enkel

Clips cheville en PVC - Simple



BESTELNUMMER N° DE COMMANDE	Ingangen Entrées	∅	
601620	1	16 - 20 mm	200 / 6000
601922	1	19 - 22 mm	125 / 3750
602125	1	21 - 25 mm	125 / 3750

Snelle betonmontage / Fixation beton rapide

Kleur : wit / Couleur : blanc



Plugclips in PVC - Dubbel

Clips cheville en PVC - Double



BESTELNUMMER N° DE COMMANDE	Ingangen Entrées	∅	
611620	2	16 - 20 mm	125 / 3750
611922	2	19 - 22 mm	75 / 2250
612125	2	21 - 25 mm	60 / 1800

Snelle betonmontage / Fixation beton rapide

Kleur : wit / Couleur : blanc



Plugclips in PVC - dubbel

Clips cheville en PVC - Double



BESTELNUMMER N° DE COMMANDE	Ingangen Entrées	∅	
411620	2	16 - 20 mm	120 / 3600

Snelle betonmontage / Fixation beton rapide

Kleur : wit / Couleur : blanc



Pluggen Chevilles

Pluggen
Chevilles



BESTELNUMMER N° DE COMMANDE	∅	
SEL712006	6 mm	100 / 4000
SEL712008	8 mm	100 / 2500
SEL712010	10 mm	50 / 1250
SEL712012	12 mm	25 / 625

High cavity pluggen - met kraag
Chevilles à haute traction - avec collerette

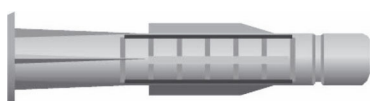

BESTELNUMMER N° DE COMMANDE	∅	
SELRXO101	6 x 35 mm	100 / 1800
SELRXO102	8 x 50 mm	50 / 900

High cavity pluggen / Chevilles à haute traction

Nylon plug voor gipsplaten
Cheville Nylon pour plaques de plâtre



BESTELNUMMER N° DE COMMANDE	∅	
SELCGO101	12,3 x 29 mm	100 / 4000

Nylon plug met houtvijs kruis
Cheville Nylon avec visse en croix



BESTELNUMMER N° DE COMMANDE	∅	
SELPXV101	6 x 60 mm	100 / 900

Nylon slagplug kruis
Cheville Nylon à frapper



BESTELNUMMER N° DE COMMANDE	∅	
SELCXP102	5 X 30 mm	100 / 2000
SELCXP104	5 X 40 mm	100 / 2000
SELCXP106	6 x 40 mm	100 / 2000

KABELBINDERS COLLIERS DE CÂBLAGE

Zwart

Noir



BESTELNUMMER N° DE COMMANDE	Afm. Dim.	
SEL3201	75 x 2,5	100 / 5000
SEL3202	100 x 2,5	100 / 5000
SEL3203	135 x 2,5	100 / 5000
SEL3204	160 x 2,5	100 / 5000
SEL3205	200 x 2,5	100 / 5000
SEL3210	140 x 3,5	100 / 5000
SEL3211	200 x 3,5	100 / 5000
SEL3216	250 x 3,5	100 / 5000
SEL3212	280 x 3,5	100 / 5000
SEL3214	360 x 3,5	100 / 4000
SEL3220	140 x 4,5	100 / 5000
SEL3221	160 x 4,5	100 / 5000
SEL3222	180 x 4,5	100 / 5000
SEL3223	200 x 4,5	100 / 5000
SEL3224	250 x 4,5	100 / 5000
SEL3425	280 x 4,5	100 / 5000
SEL3429	300 x 4,5	100 / 4000
SEL3426	360 x 4,5	100 / 4000
SEL3427	380 x 4,5	100 / 3500
SEL3428	430 x 4,5	100 / 2500
SEL3447	360 x 6,0	100 / 1500
SEL3430	180 x 7,5	100 / 2500
SEL3431	240 x 7,5	100 / 2000
SEL3432	200 X 7,5	100 / 5000
SEL3433	280 x 7,5	100 / 2000
SEL3438	320 x 7,5	100 / 1500
SEL3434	360 x 7,5	100 / 1500
SEL3436	500 x 7,5	100 / 1000
SEL3441	750 x 7,5	100 / 700
SEL3144	430 x 9,0	100 / 1000
SEL3142	550 x 9,0	100 / 700
SEL3143	780 x 9,0	100 / 500
SEL3155	1220 x 9,0	100 / 500
SEL3150	250 x 12,5	50 / 500
SEL3451	500 x 12,5	50 / 500

Nylon PA 6.6



KABELBINDERS COLLIERS DE CÂBLAGE

Zwart

Noir



BESTELNUMMER N° DE COMMANDE	Afm. Dim.	
SEL3452	750 x 12,5	50 / 500
SEL3453	1000 x 12,5	50 / 500

Nylon PA 6.6



Wit

Blanc



BESTELNUMMER N° DE COMMANDE	Afm. Dim.	
SEL2201	75 x 2,5	100 / 5000
SEL2202	100 x 2,5	100 / 5000
SEL2203	135 x 2,5	100 / 5000
SEL2204	160 x 2,5	100 / 5000
SEL2205	200 x 2,5	100 / 5000
SEL2210	140 x 3,5	100 / 5000
SEL2211	200 x 3,5	100 / 5000
SEL3215	225 x 3,5	100 / 5000
SEL2216	250 x 3,5	100 / 5000
SEL2212	280 x 3,5	100 / 5000
SEL2214	360 x 3,5	100 / 4000
SEL2220	140 x 4,5	100 / 5000
SEL2221	160 x 4,5	100 / 5000
SEL2222	180 x 4,5	100 / 5000
SEL2223	200 x 4,5	100 / 5000
SEL2224	250 x 4,5	100 / 5000
SEL2425	280 x 4,5	100 / 5000
SEL2429	300 x 4,5	100 / 4000
SEL2426	360 x 4,5	100 / 4000
SEL2427	380 x 4,5	100 / 3500
SEL2428	430 x 4,5	100 / 2500
SEL2447	360 X 6,0	50 / 500
SEL2430	180 x 7,5	100 / 2500
SEL2432	200 x 7,5	100 / 5000
SEL2431	240 x 7,5	100 / 2000

Nylon PA 6.6



KABELBINDERS COLLIERS DE CÂBLAGE

Wit
Blanc



BESTELNUMMER N° DE COMMANDE	Afm. Dim.	
SEL2433	280 x 7,5	100 / 2000
SEL2438	320 x 7,5	100 / 1500
SEL2434	360 x 7,5	100 / 1500
SEL2435	450 x 7,5	100 / 2500
SEL2436	500 x 7,5	100 / 1000
SEL3437	540 x 7,5	100 / 2500
SEL2441	750 x 7,5	100 / 700
SEL2144	430 x 9,0	100 / 1000
SEL2142	550 x 9,0	100 / 700
SEL2143	780 x 9,0	100 / 500
SEL2155	1220 x 9,0	100 / 500
SEL2450	250 x 12,5	50 / 500
SEL2451	500 x 12,5	50 / 500
SEL2452	750 x 12,5	50 / 500
SEL2453	1000 x 12,5	50 / 500

Nylon PA 6.6



Kabelbinders gekleurd
Colliers de câblage colorés



BESTELNUMMER N° DE COMMANDE	Afm. Dim.	KLEUR	COULEUR	
SEL10202R	100 x 2,5	Rood	Rouge	100 / 5000
SEL10210R	140 x 3,5	Rood	Rouge	100 / 5000
SEL10223R	200 x 4,5	Rood	Rouge	100 / 5000
SEL10425R	280 x 4,5	Rood	Rouge	100 / 5000
SEL11202R	100 x 2,5	Blauw	Bleu	100 / 5000
SEL11210R	140 x 3,5	Blauw	Bleu	100 / 5000
SEL11223R	200 x 4,5	Blauw	Bleu	100 / 5000
SEL11425R	280 x 4,5	Blauw	Bleu	100 / 5000
SEL12202R	100 x 2,5	Groen	Vert	100 / 5000
SEL12210R	140 x 3,5	Groen	Vert	100 / 5000

Rood / Rouge RAL 3000

Blauw / Bleu RAL 5002

Groen / Vert RAL 6024

Geel / Jaune RAL 1201

Nylon PA 6.6



KABELBINDERS COLLIERS DE CÂBLAGE

Kabelbinders gekleurd

Colliers de câblage colorés



BESTELNUMMER N° DE COMMANDE	Afm. Dim.	KLEUR	COULEUR	
SEL12223R	200 x 4,5	Groen	Vert	100 / 5000
SEL12425R	280 x 4,5	Groen	Vert	100 / 5000
SEL14202R	100 x 2,5	Geel	Jaune	100 / 5000
SEL14210R	140 x 3,5	Geel	Jaune	100 / 5000
SEL14223R	200 x 4,5	Geel	Jaune	100 / 5000
SEL14425R	280 x 4,5	Geel	Jaune	100 / 5000

Rood / Rouge RAL 3000

Blauw / Bleu RAL 5002

Groen / Vert RAL 6024

Geel / Jaune RAL 1201

Nylon PA 6.6



Kabelstrip wit - met markeerplaat 8 x 25 mm

Collier blanc - avec plaquette d'identification 8 x 25 mm



BESTELNUMMER N° DE COMMANDE	Afm. Dim.	
SEL.2.202T	100 x 2,5	100 / 5000

Nylon PA 6.6



UV bestendige

Résistant UV



BESTELNUMMER N° DE COMMANDE	Afm. Dim.	
SEL.UVV2.434R	360x7.5	100
SEL.UVV2.425R	280x4.5	100
SEL.UVV2.427R	380x4.5	100
SEL.UVV2.223R	200x4.5	100
SEL.UVV2.210R	140x3.5	100
SEL.UVV2.202	100x2.5	100
SEL.UVV2.426R	360x4.5	100

Nylon Pa 6.6



KABELBINDERS COLLIERS DE CÂBLAGE

Centuring Polyamide 12

Centuring Polyamide 12



BESTELNUMMER N° DE COMMANDE	Afm. Dim.	
SEL3320	180 x 9	100 / 3500
SEL3321	265 x 9	100 / 2000
SEL3322	360 x 9	100 / 1400
SEL3323	500 x 9	100 / 1000
SEL3324	750 x 9	100 / 1000



Nylon binders met Inox tand - naturel

Colliers en nylon avec dent en acier Inox - naturel



BESTELNUMMER N° DE COMMANDE	Afm. Dim.	
MET22102R	100 x 2,5	100
MET22105R	200 x 2,5	100
MET22110R	140 x 3,5	100
MET22111R	200 x 3,5	100
MET22112R	280 x 3,5	100
MET22123R	200 x 4,5	100
MET22126R	360 x 4,5	100
MET22140R	290 x 4,5	100
MET22534R	360 x 7,5	100



Nylon binders met Inox tand - zwart

Colliers en nylon avec dent en acier Inox - noir



BESTELNUMMER N° DE COMMANDE	Afm. Dim.	
MET32102R	100 x 2,5	100
MET32105R	200 x 2,5	100
MET32110R	140 x 3,5	100
MET32111R	200 x 3,5	100
MET32112R	280 x 3,5	100
MET32123R	200 x 4,5	100
MET32126R	360 x 4,5	100
MET32326R	360 x 4,5	100



KABELBINDERS COLLIERS DE CÂBLAGE

Nylon binders met Inox tand - zwart

Colliers en nylon avec dent en acier Inox - noir



BESTELNUMMER N° DE COMMANDE	Afm. Dim.	
MET32140R	290 x 4,5	100
MET32534R	360 x 7,5	50



Click Tie - herbruikbaar - Rood

Click Tie - réouvrable et réutilisable - Rouge



BESTELNUMMER N° DE COMMANDE	Afm. Dim.	
CLT102110R	120 x 3,5	100 / 5000
CLT102116R	240 x 3,8	100 / 5000
CLT102129R	320 x 4,4	100 / 5000
CLT102149R	500 x 5,6	100 / 5000



Plug voor kabelbinders M8

Cheville pour colliers de serrage M8



BESTELNUMMER N° DE COMMANDE	
MF111	100 / 3500

Plug voor kabelbinders tot 9 mm breed.

Cheville pour collier de serrage jusqu'à 9 mm de largeur.



Zelfklevende 2-weg consoles

Consoles adhésives double direction



BESTELNUMMER N° DE COMMANDE	Afm. Dim.	
SEL2501	ø 20 mm	100 / 3000
SEL2502	ø 28 mm	100 / 3000



KABELBINDERS COLLIERS DE CÂBLAGE

Identificatieplaatje

Plaquette d'identification



BESTELNUMMER N° DE COMMANDE	Afm. Dim.	
SEL101	20x40x1,3mm	100 / 3000



Klipconsoles 'Hooks' zelfklevend

Consoles clips 'Hooks' adhésives



BESTELNUMMER N° DE COMMANDE	Afm. Dim.	
SEL2401	10 x 19	100 / 3000
SEL2402	13 x 26	100 / 3000
SEL2403	18 x 26	100 / 3000



Bedradingskanalen Canaux de câblage

Type E - 6-6,5 mm - LSOH

Type E - 6-6,5 mm - LSOH

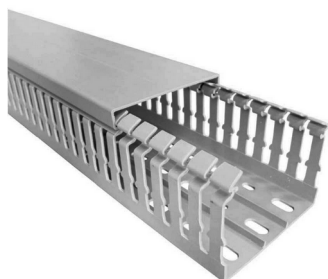

BESTELNUMMER N° DE COMMANDE	Afm. Dim.	
V6H2525	25 x 25 mm	50
V6H4025	25 x 40 mm	48
V6H4040	40 x 40 mm	50
V6H4060	60 x 40 mm	50
V6H4080	80 x 40 mm	30
V6H6025	25 x 60 mm	60
V6H6040	40 x 60 mm	40
V6H6060	60 x 60 mm	24
V6H6080	80 x 60 mm	20
V6H60100	100 x 60 mm	16
V6H60120	120 X 60 mm	12
V6H8025	25 x 80 mm	20
V6H8040	40 x 80 mm	20
V6H8060	60 x 80 mm	20
V6H8080	80 x 80 mm	12
V6H80100	100 x 80 mm	12
V6H80120	120 x 80 mm	16
V6H10060	60 x 100 mm	16
V6H10080	80 x 100 mm	16
V6H100100	100 x 100 mm	12

Lengte : 2 meter Kleur :
Grijs RAL 7035
Deksel inbegrepen
Longueur : 2 mètres
Couleur : Gris RAL 7035
Couvercle inclus



MINIKANALEN MINI GOULOTTE

TYPE INWAY LSOH

TYPE INWAY LSOH



BESTELNUMMER N° DE COMMANDE	Afm. Dim.	RAL	
IW2012.5BLH	20 x 12,5 mm	RAL 9010	80m
IW2020LH	20 x 20 mm	RAL 9010	50m
IW4017LH	40 X 17 mm	RAL 9010	30m
IW4040BLH	40 x 40 mm	RAL 9010	30m
IW6040LH	60 x 40 mm	RAL 9010	28m

Deksel inbegrepen
Lengte : 2 meter
Couvercle inclus
Longueur : 2 mètres



Mini Inway - Toebehoren

Mini Inway - Accessoires



BESTELNUMMER N° DE COMMANDE	OMSC.	DESC.	Afm. Dim.	
IWAE2012B	Buitenhc	Angle extérieur	20 x 12,5 mm	1/50
IWAE4017B	Buitenhc	Angle extérieur	40 x 17 mm	1/50
IWAE2020B	Buitenhc	Angle extérieur	20 x 20 mm	1/50
IWAE4040B	Buitenhc	Angle extérieur	40 x 40 mm	1/50
IWAE6040B	Buitenhc	Angle extérieur	60 x 40 mm	1/25
IWAI2012B	Binnenh	Angle intérieur	20 x 12,5 mm	1/25
IWAI2020B	Binnenh	Angle intérieur	20 x 20 mm	1/25
IWAI4017B	Binnenh	Angle intérieur	40 x 17 mm	1/25
IWAI4040B	Binnenh	Angle intérieur	40 x 40 mm	1/50
IWAI6040B	Binnenh	Angle intérieur	60 x 40 mm	1/25
IWAP2012B	Vlakke hoek	Angle Plat	20 x 12,5 mm	1/50
IWAP4017B	Vlakke hoek	Angle Plat	40 x 17 mm	1/50
IWAP2020B	Vlakke hoek	Angle Plat	20 x 20 mm	1/50
IWAP4040B	Vlakke hoek	Angle Plat	40 x 40 mm	1/25



MINIKANALEN MINI GOULOTTE

Mini Inway - Toebehoren

Mini Inway - Accessoires



BESTELNUMMER N° DE COMMANDE	OMSC.	DESC.	Afm. Dim.	
IWAP6040B	Vlakke hoek	Angle Plat	60 x 40 mm	1/25
IWGT2012B	T	Dérivatic "T"	20 x 12,5 mm	1/50
IWGT4017B	T	Dérivatic "T"	40 x 17 mm	1/50
IWGT2020B	T	Dérivatic "T"	20 x 20 mm	1/50
IWGT4040B	T	Dérivatic "T"	40 x 40 mm	1/25
IWGT6040B	T	Dérivatic "T"	60 x 40 mm	1/25
IWGU2012B	Koppelsl	Joint	20 x 12,5 mm	1/50
IWGU4017B	Koppelsl	Joint	40 x 17 mm	1/50
IWGU2020B	Koppelsl	Joint	20 x 20 mm	1/50
IWGU4040B	Koppelsl	Joint	40 x 40 mm	1/25
IWGU6040B	Koppelsl	Joint	60 x 40 mm	1/50
IWTT2012B	Eindstuk	Embout	20 x 12,5 mm	1/50
IWTT4017B	Eindstuk	Embout	40 x 17 mm	1/50
IWTT2020B	Eindstuk	Embout	20 x 20 mm	1/50
IWTT4040B	Eindstuk	Embout	40 x 40 mm	1/50
IWTT6040B	Eindstuk	Embout	60 x 40 mm	1/25



TYPE INWAY BLACK LSOH

TYPE INWAY BLACK LSOH

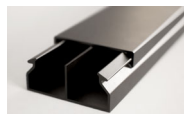

BESTELNUMMER N° DE COMMANDE	Afm. Dim.	RAL	
IW2012.5LHBlack	20 X 12,5 mm	RAL 9005	80 m
IW4017LHBlack	40 x 17 mm	RAL 9005	30 m

Deksel inbegrepen
Lengte : 2 meter
Couvercle inclus
Longueur : 2 mètres



MINIKANALEN MINI GOULOTTE

Mini Inway Black - Toebehoren

Mini Inway Black - Accessoires



BESTELNUMMER N° DE COMMANDE	OMSC.	DESC.	Afm. Dim.	
IWAE2012Black	Buitenhc	Angle extérieur	20 x 12,5 mm	1/50
IWAE4017Black	Buitenhc	Angle extérieur	40 x 17 mm	1/50
IWAI2012Black	Binnenh	Angle intérieur	20 x 12,5 mm	1/50
IWAI4017Black	Binnenh	Angle intérieur	40 x 17 mm	1/50
IWAP2012Black	Vlakke hoek	Angle Plat	20 x 12,5 mm	1/50
IWAP4017Black	Vlakke hoek	Angle Plat	40 x 17 mm	1/50
IWGT2012Black	"T" stuk	Dérivatic "T"	20 x 12,5 mm	1/50
IWGT4017Black	"T" stuk	Dérivatic "T"	40 x 17 mm	1/50
IWGU2012Black	Koppelsl	Joint	20 x 12,5 mm	1/50
IWGU4017Black	Koppelsl	Joint	40 x 17 mm	1/50
IWTT2012Black	Eindstuk	Embout	20 x 12,5 mm	1/50
IWTT4017Black	Eindstuk	Embout	40 x 17 mm	1/50



LHD

LHD



BESTELNUMMER N° DE COMMANDE	Afm. Dim.	RAL	
LHD2010HF	20 x 10 mm	RAL 9003	60 m
LHD2020HF	20 x 20 mm	RAL 9003	48 m
LHD4020HF	40 x 20 mm	RAL 9003	24 m

Deksel inbegrepen

Lengte : 2 meter

Couvercle inclus

Longueur : 2 mètres

LIJST VAN DE TOEBEHOREN - ZIE WWW.GSV.BE

LISTE DES ACCESSOIRES - SUR WWW.GSV.BE



MINIKANALEN MINI GOULOTTE

LHD

LHD



BESTELNUMMER N° DE COMMANDE	Afm. Dim.	RAL	
LHD4040HF	40 x 40 mm	RAL 9003	20 m
LHD6040HF	60 x 40 mm	RAL 9003	16m

Deksel inbegrepen

Lengte : 2 meter

Couvercle inclus

Longueur : 2 mètres

LIJST VAN DE TOEBEHOREN - ZIE WWW.GSV.BE

LISTE DES ACCESSOIRES - SUR WWW.GSV.BE



Buitenhoek

Angle extérieur



BESTELNUMMER N° DE COMMANDE	Afm. Dim.	
LHD8926HF	20 x 10 mm	1/10
LHD8626HF	20 x 20 mm	1/10
LHD8636HF	40 x 20 mm	1/10
LHD8646HF	40 x 40 mm	1/10



Binnenhoek

Angle intérieur



BESTELNUMMER N° DE COMMANDE	Afm. Dim.	
LHD8925HF	20 x 10 mm	1/10
LHD8625HF	20 x 20 mm	1/10
LHD8635HF	40 x 20 mm	1/10
LHD8645HF	40 x 40 mm	1/10
SAI160BEU	160 mm	1/10



MINIKANALEN MINI GOULOTTE

Vlakke hoek

Angle plat



BESTELNUMMER N° DE COMMANDE	Afm. Dim.	
LHD8923HF	20 x 10 mm	1/10
LHD8623HF	20 x 20 mm	1/10
LHD8633HF	40 x 20 mm	1/10
LHD8643HF	40 x 40 mm	1/10



T-stuk

Déviation-T



BESTELNUMMER N° DE COMMANDE	Afm. Dim.	
LHD8924HF	20 x 10 mm	1/10
LHD8624HF	20 x 20 mm	1/10
LHD8634HF	40 x 20 mm	1/10
LHD8644HF	40 x 40 mm	1/10



WANDKANALEN INWAY GOULOTTES INWAY

Wandkanalen LSOH

Goulotte LSOH

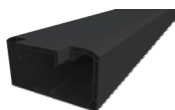
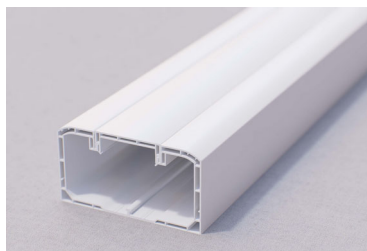

BESTELNUMMER N° DE COMMANDE	Afm. Dim.	RAL	
IW10054BLH	100 x 54 mm	RAL9003	12 m
IW10054LHBLACK	100 x 54 mm	RAL9005	12 m

Deksel inbegrepen
Lengte : 2 meter
Couvercle inclus
Longueur : 2 mètres



WANDKANALEN INWAY GOULOTTES INWAY

Toebehoren Wandkanalen INWAY

Accessoires Goulottes Murales INWAY



BESTELNUMMER N° DE COMMANDE	OMSC.	DESC.	
IWAE10054B	Verstelbare buitenhoek	Angle extérieur flexible	1/6
IWAE10054Black	Verstelbare buitenhoek	Angle extérieur flexible	1/6
IWAI10054B	Verstelbare binnenhoek	Angle intérieur flexible	1/6
IWAI10054Black	Verstelbare binnenhoek	Angle intérieur flexible	1/6
IWAP10054B	Vlakke hoek	Angle plat	1/8
IWAP10054Black	Vlakke hoek	Angle plat	1/8
IWGT10054B	T-stuk	Déviation-T	1/6
IWGT10054Black	T-stuk	Déviation-T	1/6
IWGUB100	Verbinding voor basis en deksel	Joint pour base et couvercle	1/100
IWGUB100Black	Verbinding voor basis en deksel	Joint pour base et couvercle	1/100
IWS10040B	Scheidings	Séparateur	1/8
IWS10040Black	Scheidings	Séparateur	1/8
IWTT10054B	Eindstuk	Embout	1/12
IWTT10054Black	Eindstuk	Embout	1/12



CEE STEKKERS - IP67 PRISES CEE - IP67

Stekkers

Fiches mâles

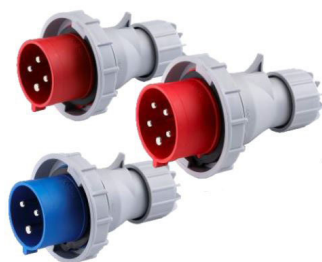

BESTELNUMMER N° DE COMMANDE	Stroomsterk Ampérage	POLEN PÔLES	SPANNING TENSION	
679316-4	16 A	3	250 V	10
679416-4	16 A	4	415 V	10
679516-4	16 A	5	415 V	10
679332-4	32 A	3	250 V	10
679432-4	32 A	4	415 V	10
679532-4	32 A	5	415 V	10
679363-8	63 A	3	250 V	1
679463-8	63 A	4	415 V	1
679563-8	63 A	5	415 V	1

IP67



Koppelstekkers

Fiches femelles



BESTELNUMMER N° DE COMMANDE	Stroomsterk Ampérage	POLEN PÔLES	SPANNING TENSION	
679316-3	16 A	3	250 V	10
679416-3	16 A	4	415 V	10
679516-3	16 A	5	415 V	10
679332-3	32 A	3	250 V	10
679432-3	32 A	4	415 V	10
679532-3	32 A	5	415 V	10
679363-7	63 A	3	250 V	1
679463-7	63 A	4	415 V	1
679563-7	63 A	5	415 V	1

IP67



CEE STEKKERS - IP67 PRISES CEE - IP67

Wanddozen

Prises murales



BESTELNUMMER N° DE COMMANDE	Stroomsterk Ampérage	POLEN PÔLES	SPANNING TENSION	
679316-2	16 A	3	250 V	10
679416-2	16 A	4	415 V	10
679516-2	16 A	5	415 V	10
679332-2	32 A	3	250 V	10
679432-2	32 A	4	415 V	10
679532-2	32 A	5	415 V	10
679363-6	63 A	3	250 V	1
679463-6	63 A	4	415 V	1
679563-6	63 A	5	415 V	1

IP67



Inbouwdozen

Prises à encastrer



BESTELNUMMER N° DE COMMANDE	Stroomsterk Ampérage	POLEN PÔLES	SPANNING TENSION	
679316-1	16 A	3	250 V	10
679416-1	16 A	4	415 V	10
679516-1	16 A	5	415 V	10
679332-1	32 A	3	250 V	10
679432-1	32 A	4	415 V	10
679532-1	32 A	5	415 V	8
679363-5	63 A	3	250 V	2
679463-5	63 A	4	415 V	2
679563-5	63 A	5	415 V	2

IP67

5polen/poles = 3polen/poles + T + N

4polen/poles = 3polen/poles + T

3polen/poles = 2polen/poles + T



Fitting in thermoplast E27

Soquet thermoplastique E27



Kelderverlichtingen

Hublots



BESTELNUMMER N° DE COMMANDE	KLEUR	COULEUR	
755	Zwart	Noir	50 / 500



BESTELNUMMER N° DE COMMANDE	Specificiteit Spécificités	VERMOGEN PUISSANCE	
460	1	100 W	1/30
470	2	100 W	1/18
471	3	60 W	1/24

Voet : PVC

Glas : Polycarbonaat / onbreekbaar.

Pied : PVC

Verre : Polycarbonate / incassable



Brandwerende E90 Anti Feu E90

Brandwerende dozen E90. Inclusief steatiet connectoren.

Boîtes Anti Feu E90. Connecteurs en stéatite inclus.



BESTELNUMMER N° DE COMMANDE	Ingangen Entrées	Afm. Dim.	Type ingang Type entrée	Aantal connectoren Nombre de connecteurs	
J100BF	7 x M25	102x102x56	Nipple	3 blocs with 2 x 1-6mm ²	1
J100MF	7 x M20/M25	102x102x56	Break-out	3 blocs with 2 x 1-6mm ²	1
J100SF	7 x M20	102x102x56	Threaded	3 blocs with 2 x 1-6mm ²	1
J160BF	10 x M25	166x116x70	Nipple	3 blocs with 2 x 1-10mm ²	1
J160MF	10 x M20/M25	166x116x70	Break-out	3 blocs with 2 x 1-10mm ²	1
J200BF	10 x M32	216x166x90	Nipple	3 blocs with 2 x 1-16mm ²	1
J200MF	10 x M32	216x166x90	Break-out	3 blocs with 2 x 1-16mm ²	1

- IP66
- DIN 4102-12
- EN 6067-22



Wartel E90

Presse-étoupe E90



BESTELNUMMER N° DE COMMANDE	Normes	AFMENTIN DIMENSIO	VERPAK. EMBAL.
BM20LA	IP68	20 mm	50
BM25LA	IP68	25 mm	20
BM32LA	IP68	32 mm	20



Brandwerende E90 Anti Feu E90

Keramische connector in steatiet

Connecteur ceramique en stéatite



BESTELNUMMER N° DE COMMANDE	Normes	∅	AFMETING DIMENSEMBAL.	VERPAK 1
J402Z	VDE	1,5-6mm	20X18X mm	1
J1602	VDE	1,5-10mm	25x23x2 mm	1
J2021	VDE	1,5-16mm	33x30x2 mm	1

Voor stijve en flexibele draad / Pour fil rigide et flexible
VDE gekeurd - certifiés VDE



Brandwerende dozen E90 M OP MAAT

Boîtes Anti Feu E90 M SUR MESURE

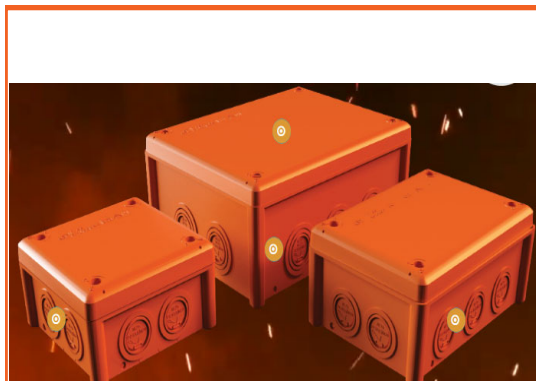

Stel uw brandwerende doos samen door
zelf het aantal steatiet connectoren te
kiezen.

Créez votre boîte anti-feu en choisissant
le nombre de connecteurs en stéatite
selon vos besoins.



FUNCTIEBEHOUD MAINTIEN DE FONCTION

FBB beugel, inclusief schroefanker - E90

Attache, cheville à visser incluse - E90

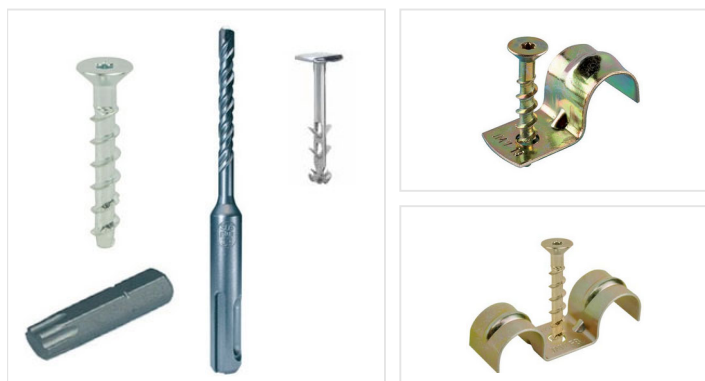

BESTELNUMMER N° DE COMMANDE	∅	VERPAK. EMBAL.
9700806	6 mm	200 / 800
9700808	8 mm	200 / 800
9700810	10 mm	200 / 800
9700812	12 mm	200 / 800
9700814	14 mm	150 / 600
9700816	16 mm	150 / 600
9700819	19 mm	150 / 600
9700825	25 mm	100 / 400
9702816	16 mm	75/300
9702819	19 mm	75/300
9700850	*1	
9700855	*2	
9700860	*3	
9230460	*4	
9700823	8 mm	100

Per verpakking een SDS boor (torx bitje) inclusief

*1 Schroefanker - TSM

*2 Schroefbit - Torx 25 - 1/4"

*3 SDS functiebehoudboor - dia. 5x110

*4 Duimnagel E30 - E90 - E120

Une mèche SDS (torx) incluse par emballage

*1 Vis maintien de fonction - TSM

*2 nr 25 Embout de vissage - Torx 25 - 1/4"

*3 Mèche SDS - dia. 5x110

*4 Cheville à Pousser E30 - E90 - E120



FBB beugel, inclusief inslaganker - E90

Attache, cheville à frapper incluse - E90

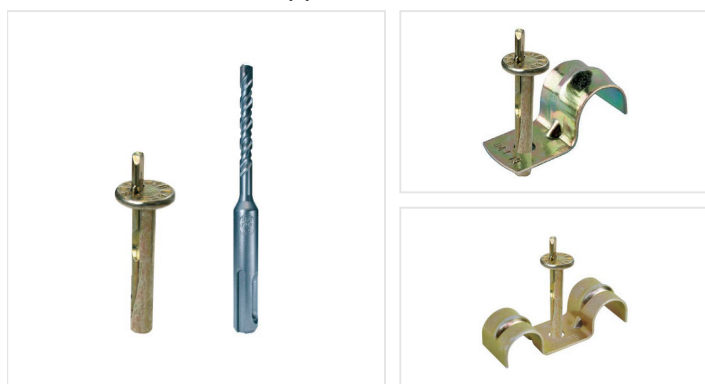

BESTELNUMMER N° DE COMMANDE	∅	VERPAK. EMBAL.
9700826	6 mm	200 / 800
9700828	8 mm	200 / 800
9700830	10 mm	200 / 800
9700832	12 mm	200 / 800

*1 SDS functiebehoudboor - dia. 6x110

*2 Inslaganker TDN 6/35

*1 Mèche SDS - dia. 6x110

*2 Cheville à frapper maintien de fonction TDN 6/35



FUNCTIEBEHOUD MAINTIEN DE FONCTION

FBB beugel, inclusief inslaganker - E90

Attache, cheville à frapper incluse - E90

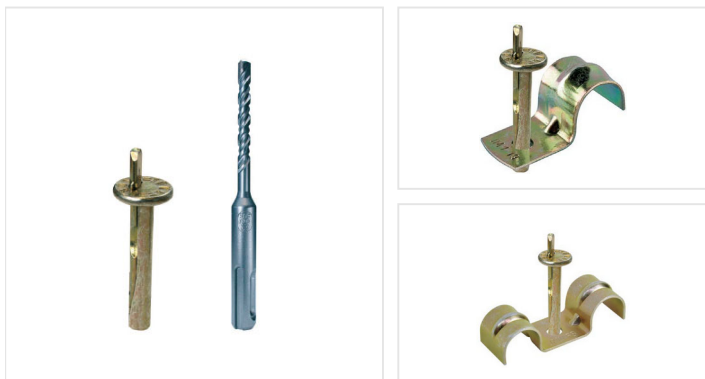

BESTELNUMMER N° DE COMMANDE	∅	VERPAK. EMBAL.
9700834	14 mm	150 / 600
9700836	16 mm	150 / 600
9700839	19 mm	150 / 600
9700845	25 mm	100 / 400
9702836	16 mm	75/300
9702839	19 mm	75/300
9700880	*2	
9700875	*1	

*1 SDS functiebehoudboor - dia. 6x110

*2 Inslaganker TDN 6/35

*1 Mèche SDS - dia. 6x110

*2 Cheville à frapper maintien de fonction TDN 6/35



FBB Beugel en Duim Nagel

Attache + cheville à pousser maintien de fonction



BESTELNUMMER N° DE COMMANDE	OMSCH	DESCRI	∅	VERPAK. EMBAL.
9700817	Enkel	Simple	16 mm	150/ 600
9700820	Enkel	Simple	19 mm	150/ 600
9702817	Dubbel	Double	16 mm	150/ 600
9702820	Dubbel	Double	19 mm	150/ 600



Schroefanker met Plug met draad M10/M8

Vis à béton et cheville avec filetage interne M10/M8



BESTELNUMMER N° DE COMMANDE	VERPAK. EMBAL.
9401052	50



FUNCTIEBEHOUD MAINTIEN DE FONCTION

Klem voor buis en kabel met eenzijdige schuifbare sluiting

Collier pour câble et tube-fermeture unilatérale coulisse



BESTELNUMMER N° DE COMMANDE	∅	VERPAK. EMBAL.
5605-16	14-18 mm	100/1300
5605-22	19-23 mm	75/1200
5605-28	24-28 mm	50/1000
5605-38	30-38 mm	40/640
5605-50	39-52 mm	30/360
5605-60	53-61 mm	20/200

E60 (volgens/selon DIN 4102-12)

Ook / aussi : INOX



Verzamelbeugel Cable guide Functiebehoudbevestiging

Collier pour câbles à maintien de fonction



BESTELNUMMER N° DE COMMANDE	AFMENTINGEN DIMENSIONS	VERPAK. EMBAL.
9702845	74x73 mm	1/36

E30-E90



Inslaganker met kraag

Douilles de frappe avec colerette

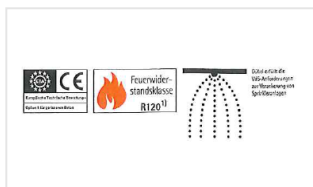

BESTELNUMMER N° DE COMMANDE	AFMENTINGEN DIMENSIONS	VERPAK. EMBAL.
2012	M6	100
2014	M8	100
2016	M10	100



FUNCTIEBEHOUD MAINTIEN DE FONCTION

Slaganker met plug met draad M8/M10

Cheville à frapper et cheville avec filetage interne M10/M8



BESTELNUMMER N° DE COMMANDE	VERPAK. EMBAL.
9401051	100



Keilbout

Boulon expansible

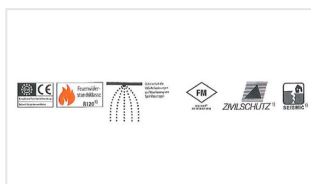

BESTELNUMMER N° DE COMMANDE	AFMENTIN DIMENSIO	RAL	VERPAK. EMBAL.
4570	M8 x32		100



Brandwerend Schroefanker - MMS Plus

Vis à maintient de fonction - MMS Plus

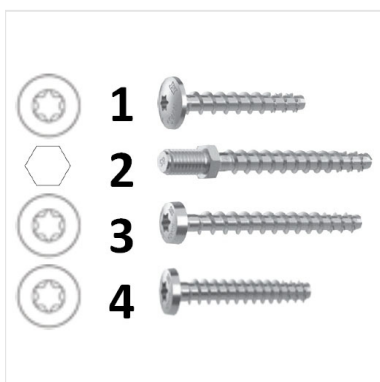

BESTELNUMMER N° DE COMMANDE	Specificiteit Spécificités	AFMENTIN DIMENSIO	VERPAK. EMBAL.
9421	1	MMS-PLUS MS 7.5X40	50
9422	2	MMS-PLUS ST 6.0X55	50
9423	3	MMS-PLUS P 6.0X50	50
9424	4	MMS-PLUS P 6.0X35	50



FUNCTIEBEHOUD MAINTIEN DE FONCTION

Ophangrail

Rail de suspension



BESTELNUMMER N° DE COMMANDE	AFMENTIN DIMENSIO	LENGTE LONGUEU	VERPAK. EMBAL.
9200900	15 x 30 mm	2m	2/20 m

Sendzimir verzinkt staal/Acier galvanisé Sendzimir
Lengte/Longueur: 2m



METALEN KANALEN CHEMINS DE CÂBLE EN METAL

Draadgoten Easy Connect - EZ

Chemins de câble Easy Connect - EZ

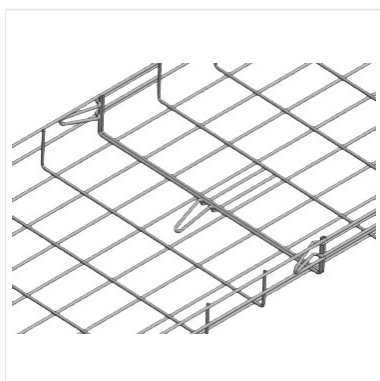

BESTELNUMMER N° DE COMMANDE	AFMENTINGEN DIMENSIONS	VERPAK. EMBAL.
EC60060EZ	60x060mm	36 / 1008 m
EC60100EZ	60x100mm	24 / 924 m
EC60150EZ	60x150mm	18 / 630 m
EC60200EZ	60x200mm	12/24/498 m
EC60300EZ	60x300mm	12 / 324 m
EC60400EZ	60x400mm	12 / 240 m
EC60500EZ	60x500mm	6 / 204 m
EC60600EZ	60x600mm	6 / 180 m

Standaard uitvoering / Finition standard

Quick Connection: met snelkoppeling / avec connexion rapide

LIJST VAN DE TOEBEHOREN - ZIE WWW.GSV.BE
LISTE DES ACCESSOIRES - SUR WWW.GSV.BE



C - Beugel voor plafond

Fixation en C pour plafond



BESTELNUMMER N° DE COMMANDE	AFMENTINGEN DIMENSIONS	VERPAK. EMBAL.
SOPC10SG	180x115x215mm	8
SOPC15SG	180x115x265mm	8
SOPC20SG	180x115x315mm	8
SOPC30SG	180x115x415mm	8



L - beugel voor Wand

Fixation en L Murale

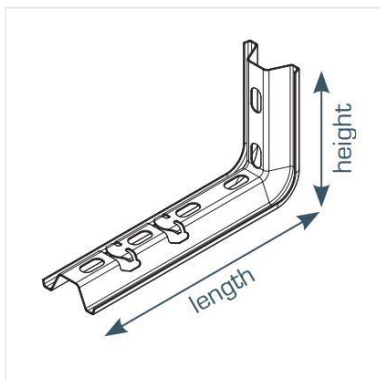

BESTELNUMMER N° DE COMMANDE	AFMENTINGEN DIMENSIONS	VERPAK. EMBAL.
SOC10SG	115x215mm	10
SOC15SG	115x265mm	10
SOC20SG	115x315mm	10
SOC30SG	115x415mm	10



METALEN KANALEN CHEMINS DE CÂBLE EN METAL

Snel Verbinder

Connecteur Rapide

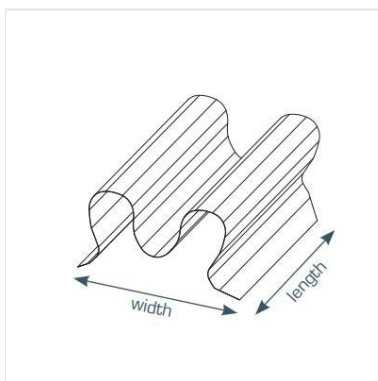

BESTELNUMMER N° DE COMMANDE	AFMENTINGEN DIMENSIONS	VERPAK. EMBAL.
MCLIC390SZ	13x23mm	100

OPMAAT SUR MESURE

Brandwerende dozen E90 M OP MAAT
Boîtes Anti Feu E90 M SUR MESURE



Stel uw brandwerende doos samen door zelf het aantal steatiet connectoren te kiezen.

Créez votre boîte anti-feu en choisissant le nombre de connecteurs en stéatite selon vos besoins.

NIEUW
NOUVEAU
REF.

OP MAAT
SUR MESURE

HALOGEN
FREE

E90



Index Produit

0		2		5		7	
031G	39	28.51	12	515	40	700-11	43
031T	39	28.53	13	515-2	40	700-16	43
1		28.61	12	516	40	700-23	43
108	38	3		516-2	40	701516	42
2		3004-18	43	517	40	701920	42
2012	70	3005-18	43	517-2	40	702-0	45
2014	70	3005-18WHITE	43	518	40	702-0WHITE	45
2016	70	3006-18	43	518-2	40	702-1	45
2035	38	3006-18WHITE	43	519	40	702-1WHITE	45
2036	38	300620W	45	519BIS	40	702-2	45
2036BLACK	26	3007-18	43	520	40	702225	42
2036D	39	3007-18WHITE	43	5605-16	70	702-2W	26
2037	38	300720W	45	5605-22	70	702-2WHITE	45
2037BLACK	26	3008-20	43	5605-28	70	702-3	45
2037D	39	3008-20WHITE	43	5605-38	70	702-3WHITE	45
2038	38	3009-20	43	5605-50	70	710-15	37
2039	38	3009-20WHITE	43	5605-60	70	710-30	37
204	38	3010-25WHITE	43	6		745-4C LG	21
20436	36	3010-35	43	601620	46	745-8C LG	21
2047	41	3011-25WHITE	44	601922	46	745-CRF748	21
2048	41	3011-35	43	602125	46	745-LAN	21
204BLACK	26	3012-25WHITE	44	611620	46	755	65
204D	39	3012-35	44	611922	46	9	
204R	38	3014-20WHITE	44	612125	46	905	40
204WHITE	26	3014-40	44	679316-1	64	90507	28
2050	41	3014-40WHITE	44	679316-2	64	90509	28
2051	41	3016-40	44	679316-3	63	90511	28
208	38	3016-40WHITE	44	679316-4	63	90513	28
208BLACK	26	3018-20WHITE	44	679332-1	64	90516	28
208R	38	3018-40	44	679332-2	64	90521	28
209	38	3018-40WHITE	44	679332-3	63	90529	28
209BLACK	26	3020-40	44	679332-4	63	90536	28
209R	38	3020-40WHITE	44	679363-5	64	90548	28
210	38	316	15	679363-6	64	905M12-DMRL01 ..	30
211	38	318	15	679363-7	63	905M16-DMRL03 ..	30
211D	39	36.81	18	679363-8	63	905M20-DMRL04 ..	30
211R	38	397-3A	23	679416-1	64	905M25-DMRL06 ..	30
219B	8	397-5	23	679416-2	64	906	41
220A	7	398-5	23	679416-3	63	90607	29
220AM	7	399-5	23	679416-4	63	90609	29
220B	8	4		679432-1	64	90611	29
222A	7	411620	46	679432-2	64	90613	29
222AM	7	424	14	679432-3	63	90616	29
222B	8	426	14	679432-4	63	906-2	41
223A	7	428	14	679463-5	64	90621	29
223AM	7	429	14	679463-6	64	90629	29
223ATA	7	430	14	679463-7	63	90636	29
223ATAM	7	430V	15	679463-8	63	90648	29
223B	8	431	14	679516-1	64	907	41
223BTA	8	431V	15	679516-2	64	90707	29
223LTATR	10	4570	71	679516-3	63	90709	29
224A	7	460	65	679516-4	63	90711	29
224AM	7	470	65	679532-1	64	90713	29
224B	8	471	65	679532-2	64	90716	29
224LTR	10	5		679532-3	63	90721	29
226B	8	50704	22	679532-4	63	90729	29
242MF	10	50706	22	679563-5	64	90736	29
250-11AM	19	50710	22	679563-6	64	90748	29
250-5AM	19	50716	22	679563-7	63	907M12	32
250-9AM	19	50725	22	679563-8	63	907M16	32
250-9B	19	512	40	7		907M20	32
273MF	19	512-2	40	700-02	43	907M20 Black	24
28.41	12	513	40	700-05	43	907M25	32
28.43	12	513-2	40	700-08	43	907M32	32
28.43-PLEXI	12	514	40	700-08 Black	43	907M40	32

Index Produit

9		B		F		I	
907M50	32	BM20LA	66	FE7	11	IWAP6040B	57
907M63	32	BM25	30	FE7 Black	27	IWGT10054B	62
908	41	BM25LA	66	H		IWGT10054Black ..	62
908M16	32	BM32	30	HF	3, 4, 5, 6,	IWGT2012B	57
908M20	32	BM32LA	66		7, 8, 9,	IWGT2012Black ...	58
908M25	32	BM40	30		10, 11,	IWGT2020B	57
908M32	33	BM50	30		12, 13,	IWGT4017B	57
908M40	33	BM63	30		14, 15,	IWGT4017Black ...	58
908M50	33	C			16, 17,	IWGT4040B	57
909M16	33	C16VD	5		18, 19,	IWGT6040B	57
909M20	33	C16VD R	5		20, 21,	IWGU2012B	57
9200900	72	C20VD	5		22, 23,	IWGU2012Black ...	58
9230460	68	C20VD R	5		24, 25,	IWGU2020B	57
9401051	71	C25VD	5		26, 27,	IWGU4017B	57
9401052	69	C25VD R	5		28, 29,	IWGU4017Black ...	58
9421	71	C25VDLHBLACK ..	6		30, 31,	IWGU4040B	57
9422	71	C32VD	5		32, 33,	IWGU6040B	57
9423	71	C32VD R	5		34, 35,	IWGUB100	62
9424	71	C40VD	5		36, 37,	IWGUB100Black ...	62
9700806	68	C40VD R	5		38, 39,	IWS10040B	62
9700808	68	C500	19		40, 41,	IWS10040Black ...	62
9700810	68	C50VD	5		42, 43,	IWTT10054B	62
9700812	68	C50VD R	5		44, 45,	IWTT10054Black ..	62
9700814	68	CFR748	21		46, 48,	IWTT2012B	57
9700816	68	CLT102110R	53		49, 50,	IWTT2012Black ...	58
9700817	69	CLT102116R	53		51, 52,	IWTT2020B	57
9700819	68	CLT102129R	53		53, 54,	IWTT4017B	57
9700820	69	CLT102149R	53		55, 56,	IWTT4017Black ...	58
9700823	68	D		I	57, 58,	IWTT4040B	57
9700825	68	DB	14	IW10054BLH	59, 60,	IWTT6040B	57
9700826	68	E		IW10054LHBLACK ..	61, 62,	J	
9700828	68	E120	70, 71	IW2012.5BLH	63, 64,	J100B	8
9700830	68	E60	70	IW2012.5LHBlack ..	65, 66,	J100BF	66
9700832	68	E90	14, 66,	IW2020LH	67, 68,	J100L	8
9700834	69		67, 68,	IW4017LH	69, 70,	J100MF	66
9700836	69		71, 72,	IW4017LHBlack ...	71, 72,	J100S	7
9700839	69		73, 75	IW4040BLH	73, 75	J100S Black	27
9700845	69	EC16	6	IW6040LH		J100S White	27
9700850	68	EC16 R	6	IWAE10054B		J100SC	7
9700855	68	EC20	6	IWAE10054Black ..		J100SF	66
9700860	68	EC20 R	6	IWAE2012B		J1602	67
9700875	69	EC20BLACK	24	IWAE2012Black ...		J160B	8
9700880	69	EC20WHITE	24	IWAE2020B		J160BF	66
9702816	68	EC25	6	IWAE4017B		J160L	8
9702817	69	EC25 R	6	IWAE4017Black ...		J160MF	66
9702819	68	EC25BLACK	24	IWAE4040B		J200B	8
9702820	69	EC60060EZ	73	IWAE6040B		J200BF	66
9702836	69	EC60100EZ	73	IWAI10054B		J200L	8
9702839	69	EC60150EZ	73	IWAI10054Black ...		J200MF	66
9702845	70	EC60200EZ	73	IWAI2012B		J2021	67
9707-ORL01	28	EC60300EZ	73	IWAI2012Black ...		J402Z	67
9709-ORL02	28	EC60400EZ	73	IWAI2020B		J80B	8
9711-ORL03	28	EC60500EZ	73	IWAI4017B		J80L	8
9713-ORL04	28	EC60600EZ	73	IWAI4017Black ...		K	
9716-ORL05	28	ECICTA20HF	4	IWAI4040B		KP64-50-2LDHF ...	14
9721-ORL06	28	ECICTA20HFT	4	IWAI6040B		KP64-50-3LDHF ...	14
9729-ORL07	28	ECICTA25HFT	4	IWAP10054B		KP64-50LDHF	14
9736-ORL08	28	ERFE20G	4	IWAP10054Black ..		KP64-60LDHF	14
9748-ORL10	28	ERFE25G	4	IWAP2012B		KPZ1PO	14
B		F		IWAP2012Black ...		L	
BM12	30	FE12	11	IWAP2020B		LHD2010HF	58
BM16	30	FE15	11	IWAP4017B		LHD2020HF	58
BM20	30	FE25	11	IWAP4017Black ...		LHD4020HF	58
BM20 Black	27	FE25 Black	27	IWAP4017Black ...		LHD4040HF	59
BM20 White	27	FE25 White	27	IWAP4040B		LHD6040HF	59

Index Produit

L		M		P		S	
LHD8623HF	60	MR3220	34	PM20	31	SEL2216	49
LHD8624HF	60	MR3225	34	PM25	31	SEL2220	49
LHD8625HF	59	MR4016	34	PM32	31	SEL2221	49
LHD8626HF	59	MR4020	34	PM40	31	SEL2222	49
LHD8633HF	60	MR4025	34	PM50	31	SEL2223	49
LHD8634HF	60	MR4032	34	PM63	31	SEL2224	49
LHD8635HF	59	MR5020	34	PST-5	36	SEL2401	54
LHD8636HF	59	MR5025	34	PST-5R	36	SEL2402	54
LHD8643HF	60	MR5032	34	PST-7	36	SEL2403	54
LHD8644HF	60	MR5040	34	PST-7R	36	SEL2425	49
LHD8645HF	59	MR6325	34	PSTB-4	36	SEL2426	49
LHD8646HF	59	MR6332	34	PSTB-4R	36	SEL2427	49
LHD8923HF	60	MR6340	34	PSTB-7	36	SEL2428	49
LHD8924HF	60	MR6350	34	PSTB-7R	36	SEL2429	49
LHD8925HF	59			R		SEL2430	49
LHD8926HF	59	N		RH18S	18	SEL2431	49
LOCKCM	17	N12-C	16	RH36/2S	18	SEL2432	49
LOCKDM	18	N12-D	17	RH54/3S	18	SEL2433	50
M		N18-C	16	RH72/4S	18	SEL2434	50
M001CS	12	N18-D	17	S		SEL2435	50
M002CS	12	N24-C	16	SAI160BEU	59	SEL2436	50
M002CSN	12	N24-D	17	SDK3	22	SEL2438	50
M003CS	12	N2x18-C	16	SDK5	22	SEL2441	50
M003CSN	12	N36-C	16	SDK8	22	SEL2447	49
M005CS	12	N36-D	17	SDKF2TR-AN	22	SEL2450	50
MCLIC390SZ	74	N3x18-C	16	SDKF3TR-AN	22	SEL2451	50
ME1216	33	N48-C	16	SDKF5TR-AN	22	SEL2452	50
ME1620	33	N48-D	17	SEL.2.202T	51	SEL2453	50
ME2025	33	N4-C	16	SEL.UVV2.202	51	SEL2501	53
ME2532	33	N4-D	17	SEL.UVV2.210R	51	SEL2502	53
ME3240	33	N4x18-C	16	SEL.UVV2.210R	51	SEL3142	48
MET22102R	52	N6-D	17	SEL.UVV2.223R	51	SEL3143	48
MET22105R	52	N8-C	16	SEL.UVV2.425R	51	SEL3144	48
MET22110R	52	N8-D	17	SEL.UVV2.426R	51	SEL3150	48
MET22111R	52	NEW	14, 25, 35, 36, 37, 51, 67, 75	SEL.UVV2.427R	51	SEL3155	48
MET22112R	52	NSET-C-D	18	SEL.UVV2.434R	51	SEL3201	48
MET22123R	52	NVIS-C-D	17	SEL101	54	SEL3202	48
MET22126R	52	O		SEL10202R	50	SEL3203	48
MET22140R	52	OL70211	44	SEL10210R	50	SEL3204	48
MET22534R	52	OL70212	44	SEL10223R	50	SEL3205	48
MET32102R	52	OL70213	44	SEL10425R	50	SEL3210	48
MET32105R	52	OL70214	44	SEL11202R	50	SEL3211	48
MET32110R	52	OL70215	44	SEL11210R	50	SEL3212	48
MET32111R	52	OL70216	44	SEL11223R	50	SEL3214	48
MET32112R	52	OL70217	44	SEL11425R	50	SEL3215	49
MET32123R	52	OL70218	44	SEL12202R	50	SEL3216	48
MET32126R	52	OMRL03 M16	31	SEL12210R	50	SEL3220	48
MET32140R	53	OMRL05 M20	31	SEL12223R	51	SEL3221	48
MET32326R	52	OMRL05A7	30	SEL12425R	51	SEL3222	48
MET32534R	53	OMRL09 M50	31	SEL14202R	51	SEL3223	48
MF111	53	OMRL10 M63	31	SEL14210R	51	SEL3224	48
MIB16	9	OMSL01	31	SEL14223R	51	SEL3320	52
MIB21	9	OMSL02	31	SEL14425R	51	SEL3321	52
MIB29	9	OMSL03	31	SEL2142	50	SEL3322	52
MIBR1620	6	OMSL04	32	SEL2143	50	SEL3323	52
MIBR1620 Black	24	OMSL05	32	SEL2144	50	SEL3324	52
MIBR1620 White	24	OMSL06	32	SEL2155	50	SEL3425	48
MR1612	34	OMSL07	32	SEL2201	49	SEL3426	48
MR2012	34	OMSL08	32	SEL2202	49	SEL3427	48
MR2016	34	opmaat	67, 75	SEL2203	49	SEL3428	48
MR2512	34	P		SEL2204	49	SEL3429	48
MR2516	34	PM12	31	SEL2205	49	SEL3430	48
MR2520	34	PM16	31	SEL2210	49	SEL3431	48
MR3212	34			SEL2211	49	SEL3432	48
MR3216	34			SEL2212	49	SEL3433	48
				SEL2214	49		

Index Produit

S

SEL3434	48
SEL3436	48
SEL3437	50
SEL3438	48
SEL3441	48
SEL3447	48
SEL3451	48
SEL3452	49
SEL3453	49
SEL712006	47
SEL712008	47
SEL712010	47
SEL712012	47
SELCGO101	47
SELCXP102	47
SELCXP104	47
SELCXP106	47
SELPXV101	47
SELRXO101	47
SELRXO102	47
SOC10SG	73
SOC15SG	73
SOC20SG	73
SOC30SG	73
SOPC10SG	73
SOPC15SG	73
SOPC20SG	73
SOPC30SG	73
ST16	35
ST16BLACK	25
ST16R	35
ST20	35
ST20BLACK	25
ST20R	35
ST25	35
ST25BLACK	25
ST25R	35
ST32	35
ST32BLACK	25
ST32R	35
ST40	35
ST-BASE	37
STC16	35
STC16BLACK	25
STC16R	35
STC20	35
STC20BLACK	25
STC20R	35
STC25	35
STC25BLACK	25
STC25R	35
STC32	35
STC32BLACK	25
STC32R	35
STC40	35
ST-CLIP	37

T

TPQSM32	20
---------	----

U

U12-C	16
U18-C	16
U24-C	16
U2x18-C	16
U36-C	16
U3x18-C	16

U

U407	5
U407 R	5
U408	5
U408 Black	25
U408 R	5
U408 White	25
U409	5
U409 Black	25
U409 R	5
U410	5
U410 R	5
U411	5
U411 R	5
U412	5
U412 R	5
U413R	5
U4-C	16
U8-C	16

V

V6H100100	55
V6H10060	55
V6H10080	55
V6H2525	55
V6H4025	55
V6H4040	55
V6H4060	55
V6H4080	55
V6H60100	55
V6H60120	55
V6H6025	55
V6H6040	55
V6H6060	55
V6H6080	55
V6H80100	55
V6H80120	55
V6H8025	55
V6H8040	55
V6H8060	55
V6H8080	55
VD16 FLH	3
VD16 LLH	3
VD16 MLH	3
VD20 FLH	3
VD20 LLH	3
VD20 LLHBLACK	3
VD20 MLH	3
VD20HFPPMOF	4
VD25 LH	3
VD25 LLH	3
VD25 LLHBLACK	3
VD25HPPPMOF	4
VD32 LH	3
VD32 LLH	3
VD40 LH	3
VD50 LH	4
VD63 LH	4

WWW.GSV.BE

01/2025



#GSV-WEB



#GSV

TERBEKEHOFDREEF 51
2610 WILRIJK

T: +32 3 326 50 77
F: +32 3 326 49 23

WWW.GSV.BE
E: office@gsv.be

BTW/TVA BE 0427.142.369
HRA/RCA 245.824



GSV

SINDS | DEPUIS 1985
WIJ BEVESTIGEN UW TOEKOMST
UNE ATTACHE POUR VOTRE AVENIR