

BEVESTIGINGSMATERIAAL MATERIEL DE FIXATION

CATALOGUS
CATALOGUE

2020
01



SINDS – DEPUIS 1985

WIJ BEVESTIGEN UW TOEKOMST
UNE ATTACHE POUR VOTRE AVENIR

BESCHERMING EN VEILIGHEID PROTECTION ET SECURITE

Hand Protective Foam
Mousse de protection pour main



BESTELNUMMER N° DE COMMANDE	INHOUD CONTENU	
W11850200	200 ml	1

Data sheets and certificate on www.gsv.be

Hydroalcoholische handgel 72%
Gel pour mains hydroalcolique 72%



BESTELNUMMER N° DE COMMANDE	Afm. Dim.	INHOUD CONTENU	
VS120E	290 x 195 x 120	120ml	1/24
VS250E	210 x 160 x 185	250ml	1/12
VS500E	245 x 165 x 170	500ml	1/6
VS03XLDE	380 x 300 x 200	3L*1	1/4
VS05XLE	280 x 200 x 295	5L*2	1/2

*1 Met pomp / avec pompe

*2 Voor navulling / recharge

(EC) No 1272/2008

Ready-to-use

Varwacht / Attendu le 01/07/2020



Optische rookmelder - Mini Formaat
Détecteur de fumée Optique - Mini Format



BESTELNUMMER N° DE COMMANDE	Specificiteit Spécificités	Afm. Dim.
MF001	*1	ø 50 mm x 43 mm
MF002	*2	ø 50 mm x 43 mm

85dB

EN14604:2005 ; + AC:2008

CE conform

*1 Vervangbare CR2 batterij ; 5 jaar

Batterie CR2 remplaçable ; 5 ans

*2 Niet vervangbare CR123A/CR17335 batterij ; 10 jaar

Batterie CR123A/CR17335 incluse non-remplaçable ; 10 ans

GEL/HARS GEL/RESINE

GEL - Twee componenten

GEL - Bi composant



BESTELNUMMER N° DE COMMANDE	INHOUD CONTENU
MP0100	1 L (2 X 0,5 L.)
MP0030	300 ml
MP2200	2 L
MP1000	10 L

GEL - Eén component - Cartridge

GEL - Mono composant - Cartouche



BESTELNUMMER N° DE COMMANDE	INHOUD CONTENU
MPONE GEL	300 ml (Injecteerbaar / Injectable)

Polyurethaan hars - Twee componenten

Résine polyuréthane - Bi composant



BESTELNUMMER N° DE COMMANDE	INHOUD CONTENU
RS150	0,110 L
RS300	0,220 L
RS400	0,290 L
RS550	0,400 l
RS650	0,470 L
RS1650	1,200 L

Met veiligheids vulsysteem
Avec système de remplissage sécurisé

SHARK - Rechte koppelingen gevuld met gel - met connector

SHARK - Joints pré-remplis en gel - avec connexion



BESTELNUMMER N° DE COMMANDE	∅	Afm. Dim.	Polen Poles
SHARK150	*	86x47 mm	1
SHARK325	1,5 - 2,5 mm ²	86x47 mm	3
SHARK306	1,5 - 6 mm ²	145x50 mm	3

*6 à 25 mm² : voor harde draad
35mm² : voor flexibele draad
*6 à 25 mm² : pour câble rigide
35mm² : pour câble souple

GEL/HARS GEL/RESINE

SHARK - Rechte koppelingen gevuld met gel - met connector

SHARK - Joints pré-remplis en gel - avec connexion



BESTELNUMMER N° DE COMMANDE	∅	Afm. Dim.	Polen Poles
SHARK516	6 - 16 mm ²	180x69 mm	5
SHARK506	1,5 - 6 mm ²	146x50 mm	5

*6 à 25 mm² : voor harde draad

35mm² : voor flexibele draad

*6 à 25 mm² : pour câble rigide

35mm² : pour câble souple

Y Koppeling gevuld met Gel Met Connector

Joint en Y pré-rempli en Gel avec Connexion



BESTELNUMMER N° DE COMMANDE	∅	Afm. Dim.	Polen Poles
SHARK516Y	6 - 16 mm ²	220 x 110 mm	5

*6 - 16 mm²

SHARK - Rechte koppelingen gevuld met gel

SHARK - Joints pré-remplis en gel



BESTELNUMMER N° DE COMMANDE	∅	Afm. Dim.	Polen Poles
SHARK506WS	6 - 16 mm ²	180x69 mm	5
SHARK525WS	6 - 25 mm ²	240x75 mm	5

Met connector & trekontlasting

Avec connexion & serre-câble

GEL/HARS GEL/RESINE

SHARK68 - Rechte koppelingen IP68

SHARK68 - Joints IP68



BESTELNUMMER N° DE COMMANDE	∅	Polen Poles
SHARK6801A	6 - 50 mm ²	1
SHARK6801B	1,5 - 6 mm ²	3
SHARK6801C	1,5 - 6 mm ²	3
SHARK6801D	2,5 - 6 mm ²	4
SHARK6802A	2,5 - 10 mm ²	5
SHARK6803A	10 - 25 mm ²	5

IP 68



Koppeling gevuld met Gel - IP68 - Voor Tuinspot

Jonction IP68 pré-remplie de Gel pour Spot Led encastrable



BESTELNUMMER N° DE COMMANDE	∅	Afm. Dim.	
LDJ01	0,5 - 1,5 mm ²	118x25 mm	1

IP68, 450V, 24A; EN60529

LEDJOY
SMART CONNECTION

Met gel gevulde Mini Box
pré-rempli de gel



BESTELNUMMER N° DE COMMANDE	Normes	∅	Afm. Dim.	
MJB112	IPX8, CE, EN 60947-7-1, EN 60998-2-2, 600V, 32A	0,2 - 4 mm ²	33x26x2 mm	2/12
MJB113	IPX8, CE, EN 60947-7-1, EN 60998-2-2, 600V, 32A	0,2 - 4 mm ²	33x26x2 mm	2/12
MJB215	IPX8, CE, EN 60947-7-1, EN 60998-2-2, 600V, 32A	0,2 - 4 mm ²	33x34x23 mm	1/12

GEL/HARS GEL/RESINE

Met gel gevulde Mini Box
pré-rempli de gel



BESTELNUMMER N° DE COMMANDE	Normes	ø	Afm. Dim.	
MJB222	IPX8, CE, EN 60947-7-1, EN 60998-2-2, 600V, 32A	0,2 - 4 mm ²	33x34x23 mm	1/12
MJB332	IPX8, CE, EN 60947-7-1, EN 60998-2-2, 600V, 32A	0,2 - 4 mm ²	33x46x23 mm	1/12

Vorstwerend Snoer Cable anti-gel



BESTELNUMMER N° DE COMMANDE	∅	Afm. Dim.	
EASY02	0,2 - 4 mm2	2 m	1
EASY04	0,2 - 4 mm2	4 m	1
EASY08	0,2 - 4 mm2	6 m	1
EASY12	0,2 - 4 mm2	12 m	1
EASY18	0,2 - 4 mm2	18 m	1

Incl. Thermost. IPX7, 230V

PVC - LSOH PVC - LSOH

Kabeldozen met uitbrekbare ingangen voor wartels

Boîtes de dérivation avec entrées pré-imprimées



BESTELNUMMER N° DE COMMANDE	Ingangen Entrées	∅	Afm. Dim.	
220A	7	PG 16	80x80x50	10
220AM	7	20 mm	80x80x50	10

220A : Pg-maten / Mesures Pg

220AM : Metrische maten / Mesures métriques

IP 54 Druksluiting / Serrage à pression



Kabeldozen met uitbrekbare ingangen

Boîtes de dérivation avec entrées pré-imprimées



BESTELNUMMER N° DE COMMANDE	Ingangen Entrées	∅	Afm. Dim.	
222A	6	PG 16	100x100x55	5
223A	10	PG 16	175x110x66	2
223ATA	10	PG 16	175x110x83	2
224A	10	PG 29	220x170x120	1
222AM	6	20 mm	100x100x55	5
223AM	10	20 mm	175x110x66	2
223ATAM	10	20 mm	175x110x83	2
224AM	10	25 mm	220x170x120	1

222A à 224A : Pg-maten / Mesures Pg

222AM à 224AM : Metrische maten / Mesures métriques

Schroefsluiting / Serrage à vis 3/4"

IP 65



BOX LINE Kabeldoos met metrische schroefingangen

BOX LINE Boîte de dérivation avec filetage métrique

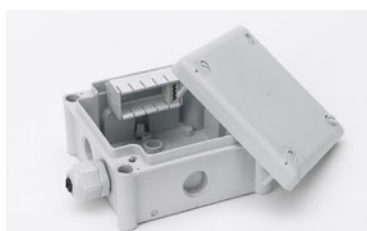

BESTELNUMMER N° DE COMMANDE	Ingangen Entrées	∅	Afm. Dim.	
J100S	7	M20	102²x56 mm	90
J100S CONNECTOR	7	M20	102²x56 mm	90

inclusief connector 3-fasen+n+t

inclus barrette 3-phases+n+t

IP 66



PVC - LSOH PVC - LSOH

BOX LINE Kabeldozen met nippel

BOX LINE Boîtes de dérivation avec entrées étanches



BESTELNUMMER N° DE COMMANDE	Ingangen Entrées	ø	Afm. Dim.	
J80B	8	M25	83²x50mm	1
J100B	8	M25	102²x56mm	1
J160B	8	M25	116²x70mm	1
J200B	8	M32	153x205x 87mm	1

IP 66



BOX LINE Kabeldozen gesloten

BOX LINE Boîtes de dérivation fermée



BESTELNUMMER N° DE COMMANDE	Ingangen Entrées	ø	Afm. Dim.	
J80L	8	M25	83 x 83 x 50 mm	1
J100L	8	M25	102 x 102 x 56mm	1
J160L	8	M25	166 x 116 x 70 mm	1
J200L	8	M32	153 x 205 x 87 mm	1

IP 66



Kabeldozen met nippels

Boîtes de dérivation avec entrées étanches



BESTELNUMMER N° DE COMMANDE	Ingangen Entrées	ø	Afm. Dim.	
219B	4*	Pg21	45 x ø80 mm	10
220B	7*	20mm	80 x 80 x 50 mm	10
222B	6**	Pg21	100 x 100 x 55 mm	5
223B	10**	Pg21	175 x 110 x 66 mm	2
223BTA	10**	Pg21	175 x 110 x 83 mm	2
224B	10**	Pg29	220 x 170 x 120 mm	1
226B	10**	Pg29	220 x 170 x 120 mm	1

*Druksluiting / Serrage à pression

**Schroefsluiting 3/4" / Serrage à vis 3/4"

IP 54



Toebehoren Accessoires

Nippels
Embouts à gradin



BESTELNUMMER N° DE COMMANDE	Afm. Dim.	
MIB16	3,5-20 mm	50
MIB21	3,5-23,5 mm	50
MIB29	3,5-32 mm	50



Groot formaat Grands formats

Kabeldozen gesloten

Boîtes de dérivation fermées



BESTELNUMMER N° DE COMMANDE	Afm. Dim.
MF242	322x275x185



Kabeldozen volledig gesloten met transparant deksel

Boîtes de dérivation fermées avec couvercle transparente



BESTELNUMMER N° DE COMMANDE	Afm. Dim.
223LTATR	175x110x83
224LTR	220x170x120

Schroefsluiting 3/4" / Serrage à vis 3/4"



Kabeldozen PH-4A.1

Boîtes de dérivation IP65



BESTELNUMMER N° DE COMMANDE	Normes	Afm. Dim.	
28.41	IP65	248x198x96	1
28.51	IP65	348x228x142	1
28.61	IP65	400x262x140	1



Kabeldozen met nippels PH-4A.3

Boîtes de dérivation avec entrées étanches PH-4A.3

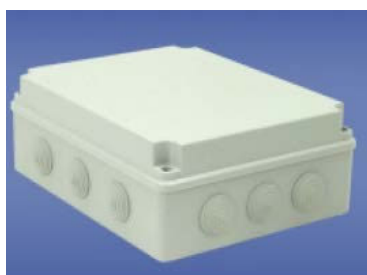

BESTELNUMMER N° DE COMMANDE	Specificiteit Spécificités	Normes	Afm. Dim.	
28.43		IP65	248x198x96	1
28.43-PLEXI	*4		*248x198x96	1

*Met Plexi deksel

* Avec couvercle en Plexi



Groot formaat Grands formats

Kabeldozen met nippels PH-5A.3

Boîtes de dérivation avec entrées étanches PH-5A.3



BESTELNUMMER N° DE COMMANDE	Normes	Afm. Dim.	
28.53	IP65	348x228x142	1



Thermoplastisch Thermoplastique

Kabeldozen

Boîtes de dérivation



BESTELNUMMER N° DE COMMANDE	Ingangen Entrées	ø	Afm. Dim.	
FE25	10	1,5-4mm	89x43x37	10/150
FE7	7	1,5-4mm	75x75x37	10/300
FE12	12	1,5-4mm	85x85x37	10/150
FE15	12	1,5-4mm	100x100x37	10/128



Met soupele ingang Avec membrane

Ronde Kabeldoos met soupele ingang
Boîte ronde de dérivation avec membrane



BESTELNUMMER N° DE COMMANDE	Afm. Dim.	
M001CS	ø 65x40 mm	1
M002CS	ø 80x40 mm	1



Kabeldoos met soupele ingang
Boîte de dérivation avec membrane



BESTELNUMMER N° DE COMMANDE	Afm. Dim.	
M003CS	80x80x40 mm	1
M005CS	100x100x40 mm	1



Brandwerende E90 Anti Feu E90

Brandwerende dozen E90 connectors incl.
Boîtes Anti Feu E90 connecteurs incl.



BESTELNUMMER N° DE COMMANDE	Ingangen Entrées	∅	Afm. Dim.	
J100BF	7*	M25	102x102x56	1
J100SF	6+1*	M20+M25	102x102x56	1
J160BF	10	M25	166x116x70	1
J200BF	10	M32	216x166x90	1

*Schroefingangen

*Entrées filetées

IP66 - Volgens - Selon DIN 4102-12 - Kema EN 60670-22

Keramische connector in steatiet inclusief

Connecteur ceramique en stéatite inclus



Wartel E90
Presse-étoupe E90



BESTELNUMMER N° DE COMMANDE	Normes	Afm. Dim.	
BM20LA	IP68	20 mm	50
BM25LA	IP68	25 mm	20



Keramische connector in steatiet
Connecteur ceramique en stéatite



BESTELNUMMER N° DE COMMANDE	Normes	∅	Afm. Dim.	
J402	VDE	1,5-6mm ²	20X18X15 mm	1
J1602	VDE	1,5-10mm ²	25x23x21 mm	1
J2021	VDE	1,5-16mm ²	33x30x23 mm	1

Voor stijve en flexibele draad / Pour fil rigide et flexible
VDE gekeurd - certifiés VDE



Metalen dozen
Boîtes métalliques



BESTELNUMMER N° DE COMMANDE	Afm. Dim.	
040CDTM254	90x90x47	1
040CDTM255	110x110x51	1
040CDTM256	130x130x60	1
040CDTM257	150x150x72	1
040CDTM258	200x200x90	1

OP BESTELLING / SUR COMMANDE : INOX

SNELVERBINDERS CONNECTEURS RAPIDES

Universele steekklemmen
Raccords universels



BESTELNUMMER N° DE COMMANDE	
SDKF2TR-AN	100 / 2000
SDKF3TR-AN	75 / 1500
SDKF5TR-AN	50 / 1000

Steekklemmen voor harde draad
Raccords pour fil rigide



BESTELNUMMER N° DE COMMANDE	
SDK3	100 / 1000
SDK5	100 / 2000
SDK8	100 / 1000

Aaneenschuifbare steekklemmen
Raccords câble à juxtaposer



BESTELNUMMER N° DE COMMANDE	
J273-3	100 / 2400
J273-4	100 / 2400
J273-5	100 / 2400



Lusterklemmen
Raccords lustre



BESTELNUMMER N° DE COMMANDE	Ø	
50704	2,5 - 4 mm ²	10
50706	6 mm ²	10
50710	10 mm ²	10
50716	16 mm ²	10
50725	25 mm ²	10

24A , 450V, CE, HF, PP
Wit / Blanc

SNELVERBINDERS CONNECTEURS RAPIDES

Klemstenen

Barrettes de connection



BESTELNUMMER N° DE COMMANDE	Specificiteit Spécificités	
397-5	*1	20
398-5	*2	20
399-5	*3	10

*1 Voor montage in dozen / Pour montage en boîtes : 220A / 220B / 222A/ 222B / 222L

*2 Voor montage in dozen / Pour montage en boîtes : FE25 / FE7 / FE12

*3 Voor montage in dozen / Pour montage en boîtes : BOX LINE

INBOUWDOZEN BOITES D'ENCASTREMENT

Hollewanddozen
Boîtiers pour mur creux



BESTELNUMMER N° DE COMMANDE	MOD.	ø	Afm. Dim.	
424	1	68 mm	45 mm	10/280
426	1	68 mm	61 mm	10/240
428	2	68 mm	45 mm	5/130
429	3	68 mm	45 mm	5/90



Hollewanddozen - Harde uitvoering
Boîtiers pour mur creux - Module rigide PVC



BESTELNUMMER N° DE COMMANDE	MOD.	Afm. Dim.	
KP64LD	1*	68x70x45mm	100
KP642L	2	142x70x45mm	50
KP643L	3	213x70x45mm	36
KP644L	4	285x70x45mm	24
KP645L	5	354x70x45mm	20

KP64LD = winddicht type
KP64LD = type étanche à l'air

Hollewanddoos Harde Uitvoering - Winddicht
Boitier Rigide Pour Mur Creux - Etanche



BESTELNUMMER N° DE COMMANDE	MOD.	Afm. Dim.	
KP64-50LD	1	68x70x50mm	110
KP64-60LD	1	68x70x60mm	84
KP64-50-2LD	2	142x70x50mm	40
KP64-50-3LD	3	213x70x50mm	30
KP64-50-4LD	4	284x70x50mm	25

Universele inbouwdozen zonder Vijs
Boîtiers d'encastrement universel sans Vis

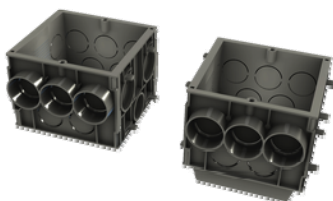

BESTELNUMMER N° DE COMMANDE	MOD.	Afm. Dim.	
430	1	60x60x50mm	10/200
431	1	60x60x65mm	10/200



INBOUWDOZEN BOITES D'ENCASTREMENT

Universele inbouwdozen met Vijs
Boîtiers d'encastrement universel avec Vis



BESTELNUMMER N° DE COMMANDE	MOD.	Afm. Dim.	
430V	1	60x60x50mm	10/200
431V	1	60x60x65mm	10/180



Inbouwdozen
Boîtiers d'encastrement



BESTELNUMMER N° DE COMMANDE	MOD.	Afm. Dim.	
316	1	75x75x42mm	10/100
318	1	75x75x60mm	10/100



VERDEELKASTEN COFFRETS DE DISTRIBUTION

Verdeelkasten opbouw Type C / IP 40 In-63A

Coffrets de distribution en saillie Type C / IP 40 In-63A



BESTELNUMMER N° DE COMMANDE	MOD.	Afm. Dim.
N4-C	1 x 4	232x139x99 mm
N8-C	1 x 8	215x236x112 mm
N12-C	1 x 12	287x236x112 mm
N18-C	1 x 18	396x236x112 mm
N24-C	2 x 12	287x361x112 mm
N36-C	3 x 12	287x485x112 mm
N2x18-C	2 x 18	396x361x112 mm
N3x18-C	3 x 18	396x526x112 mm
N48-C	4 x 12	287x651x112 mm
N4x18-C	4 x 18	651x396x112 mm

Din rail en aardingsrail inclusief en geïnstalleerd
Rail Din et barrette de terre pré-installé



Verdeelkasten inbouw Type C / IP 40 In-63A

Coffrets de distribution à encastrer Type C / IP 40 In-63A



BESTELNUMMER N° DE COMMANDE	MOD.	Afm. Dim.
U8-C	1 x 8	211x232x99 mm
U12-C	1 x 12	283x232x106 mm
U18-C	1x 18	392x232x106 mm
U24-C	2 x 12	283x357x106 mm
U36-C	3 x 12	283x482x106 mm
U2x18-C	2 x 18	392x357x106 mm
U3x18-C	3 x 18	392x522x106 mm
U4-C	1 x 4	211 x 232 x 99 mm

Din rail en aardingsrail inclusief en geïnstalleerd
Rail Din et barrette de terre pré-installé



Verdeelkasten opbouw Type D / IP 65 In-63A

Coffrets de distribution en saillie Type D / IP 65 In-63A



BESTELNUMMER N° DE COMMANDE	MOD.	Afm. Dim.
N8-D	1 x 8	200x200x120 mm
N4-D	1 x 4	127x200x120 mm

Din rail en aardingsrail inclusief en geïnstalleerd
Rail Din et barrette de terre pré-installé



VERDEELKASTEN COFFRETS DE DISTRIBUTION

Verdeelkasten opbouw Type D / IP 65 In-63A

Coffrets de distribution en saillie Type D / IP 65 In-63A



BESTELNUMMER N° DE COMMANDE	MOD.	Afm. Dim.
N12-D	1 x 12	318x258x142 mm
N36-D	3 x 12	318x507x142 mm
N24-D	2 x 12	318x383x142 mm

Din rail en aardingsrail inclusief en geïnstalleerd
Rail Din et barrette de terre pré-installé



Verdeelkasten opbouw Type NEO / IP 65 In-100A

Coffrets de distribution en saillie Type NEO / IP 65 In-100A



BESTELNUMMER N° DE COMMANDE	MOD.	Afm. Dim.
RH18S	1 x 18	435x260x138 mm
RH36/2S	2 x 18	435x420x138 mm
RH54/3S	3 x 18	435x580x138 mm
RH72/4S	4 x 18	435x780x138 mm



Verdeelkasten opbouw IP 55 Incl. din rail

Coffrets de distribution en saillie IP 55



BESTELNUMMER N° DE COMMANDE	Ingangen Entrées	MOD.	Afm. Dim.
250-5AM	6xM20+4xM25	4 + 1	95x162x122 mm
250-9AM	6xM20+4xM25	8 + 1	98x162x202 mm
250-11AM	10xM25	10 + 1	109x232x182 mm
250-9B	10 x PG21 met Nippels	8+1	98 X 162 X 202 mm



Afdekplaatjes voor MCB - Wit - 12 modulen

Couvercles universels pour MCB - Blanc - 12 modules



BESTELNUMMER N° DE COMMANDE	Afm. Dim.	
273MF	200x52x8 mm	10



VERDEELKASTEN COFFRETS DE DISTRIBUTION

Stopcontact voor borden - DIN Rail 35 mm

Prise de courant pour tableau - DIN Rail 35mm



BESTELNUMMER N° DE COMMANDE	A	Spanning Tension	
C500	16A	230V	1/5

VDE -EN 50 0 22



KAMGELEIDERS BARRE DE PONTAGE

Kamgeleiders met vork
Barre de Pontage avec fourche

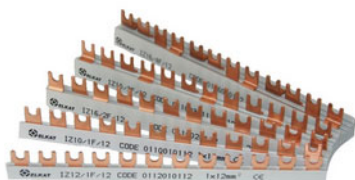

BESTELNUMMER N° DE COMMANDE	MOD.	FASES PHASES	∅	
IZ10/2F/54	54	L1,L2/N	10mm	20
IZ10/3F/54	54	L1,L2,L3	10mm	20
IZ16/2F/54	54	L1,L2/N	16mm	10
IZ16/3F/54	54	L1,L2,L3	16mm	20
IZ16/4F/56	56	L1,L2,L3,N	16mm	10

Lengte / Longueur: 1m

Kamgeleiders met pin
Barre de Pontage avec broche

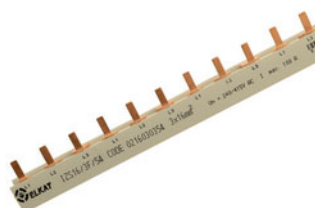

BESTELNUMMER N° DE COMMANDE	MOD.	FASES PHASES	∅	
IZS10/3F/54	54	L1,L2,L3	10mm	20
IZS16/2F/54	54	L1,L2/N	16mm	10
IZS16/3F/54	54	L1,L2,L3	16mm	20
IZS16/4F/56	56	L1,L2,L3,N	16mm	10

Lengte / Longueur: 1m

Eindstuk
Embout



BESTELNUMMER N° DE COMMANDE	∅	
Z10/16/3F	10 & 16 mm ²	10/250
Z16/2F	16 mm ²	10/250
Z16/4F	16 mm ²	10/250

VLOERDOZEN BOÏTE POUR SOL

Vloerdozen voor toebehoren 45 x 45

Boîtes sol pour accessoires 45 x 45

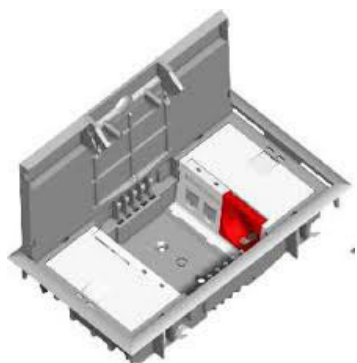

BESTELNUMMER N° DE COMMANDE	MOD.	Afm. Dim.
745-4C LG	4	146x250x56 mm
745-8C LG	8	250x250x56 mm



Kader voor vloerdoos voor gebruik in beton / chape

Cadre pour boîte sol pour chape de béton



BESTELNUMMER
N° DE COMMANDE

CFR748

Polystyreen blok voor vloerdoos

Bloc Polystyrène pour boîte sol



BESTELNUMMER
N° DE COMMANDE

MOD.

745-EPS4M

4

745-EPS8M

8

Dubbele afdekplaat + 2 stekkers RJ45 CAT 6

Plaque double + 2 connecteurs RJ45 CAT6



BESTELNUMMER
N° DE COMMANDE

Specificiteit
Spécificités

745-LAN

CAT 6



PVC BUIZEN EN TOEBEHOREN TUBES PVC ET ACCESSOIRES

Rechte buizen
Tubes rigides



BESTELNUMMER N° DE COMMANDE	ø IN	Lengte Longueur	
VD16-2M	16 mm	2 m	30/4050 m
VD20-2M	20 mm	2 m	30/4050 m
VD16	16 mm	3 m	111/5550 m
VD20	20 mm	3 m	111/5550 m
VD25	25 mm	3 m	111/5130 m
VD32	32 mm	3 m	57 m
VD40	40 mm	3 m	30 m
VD50	50 mm	3 m	15 m

Light Grey = RAL 7035

Rechte buizen
Tubes rigides



BESTELNUMMER N° DE COMMANDE	ø IN	Lengte Longueur	
VD16 R-2M	16 mm	2 m	30/4050 m
VD20 R-2M	20 mm	2 m	30/4050 m
VD16 R	16 mm	3 m	111/5550 m
VD20 R	20 mm	3 m	111/5550 m
VD25 R	25 mm	3 m	111/5130 m
VD32 R	32 mm	3 m	57 m
VD40 R	40 mm	3 m	30 m
VD50 R	50 mm	3 m	15 m

R = Dark Grey = RAL 7037

Rechte buizen met mof
Tubes rigides tulipés



BESTELNUMMER N° DE COMMANDE	ø	
VD20 G	20 mm	111 m / 5.550 m

Lengte / Longueur: 3m
Light Grey = RAL 7035

PVC BUIZEN EN TOEBEHOREN TUBES PVC ET ACCESSOIRES

Buizen HALOGEN FREE- PC
Tubes HALOGEN FREE - PC



BESTELNUMMER N° DE COMMANDE	∅	
VD16 LLH	16 mm	111/5550 m
VD20 LLH	20 mm	111/5550 m
VD20 LLHBLACK	20 mm	111/5550 m
VD25 LLH	25 mm	57/5130 m
VD32 LLH	32 mm	57 /4275 m

Light Load (2442) : LLH
Lengte / Longueur: 3m
RAL 7035
PC = polycarbonaat/polycarbonate



Buizen HALOGEN FREE - PC
Tubes HALOGEN FREE - PC



BESTELNUMMER N° DE COMMANDE	∅	
VD16 MLH	16 mm	111/5550 m
VD20 MLH	20 mm	111/5550 m

Medium Load (3442) : MLH
Lengte / Longueur: 3m
RAL 7035
PC = polycarbonaat/polycarbonate



Buizen HALOGEN FREE - PC
Tubes HALOGEN FREE - PC



BESTELNUMMER N° DE COMMANDE	∅	
VD16 FLH	16 mm	111/5550 m
VD20 FLH	20 mm	111/7992 m
VD25 LH	25 mm	57/5130 m
VD32 LH	32 mm	57/4275 m
VD40 LH	40 mm	30 m
VD50 LH	50 mm	15 m
VD63 LH	63 mm	3 m

Heavy Load (4442) : FLH/LH
Lengte / Longueur: 3m
RAL 7035
PC = polycarbonaat/polycarbonate



PVC BUIZEN EN TOEBEHOREN TUBES PVC ET ACCESSOIRES

Buizen HALOGEN FREE - PP

Tubes HALOGEN FREE - PP



BESTELNUMMER N° DE COMMANDE	∅	
VD20HFPP	20 mm	105 m

Light Grey = RAL 7035

PP= polypropylène/polypropyleen



Buizen HALOGEN FREE PP met manchet

Tubes HALOGEN FREE PP avec manchon



BESTELNUMMER N° DE COMMANDE	∅	
VD20HFPPMOF	20 mm	102 m
VD25HPPPMOF	25 mm	75 m

Light Grey = RAL 7035

PP= polypropylène/polypropyleen



Buis halfzacht, met trekdraad

Tube semi rigide, avec tire-fil



BESTELNUMMER N° DE COMMANDE	∅	
ERFE20G	20 mm	100 m
ERFE25G	25 mm	50 m



Ribbenbuis met trekdraad

Flex avec tire-fil



BESTELNUMMER N° DE COMMANDE	∅	
ECICTA20HFT	20 mm	100 m



PVC BUIZEN EN TOEBEHOREN TUBES PVC ET ACCESSOIRES

Moffen voor rechte PVC buis

Manchons pour conduite rigide en PVC



BESTELNUMMER N° DE COMMANDE	∅	RAL	
U407	16 mm	RAL 7035	100/2500
U408	20 mm	RAL 7035	100/1600
U409	25 mm	RAL 7035	25/1150
U410	32 mm	RAL 7035	25/600
U411	40 mm	RAL 7035	25
U412	50 mm	RAL 7035	5
U407 R	16 mm	RAL 7037	100/2500
U408 R	20 mm	RAL 7037	100/1600
U409 R	25 mm	RAL 7037	25/1150
U410 R	32 mm	RAL 7037	25/600
U411 R	40 mm	RAL 7037	25
U412 R	50 mm	RAL 7037	5

Light Grey = RAL 7035

R = Dark Grey = RAL 7037



Bochten 90° voor rechte PVC buis

Coudes 90° pour conduite rigide en PVC



BESTELNUMMER N° DE COMMANDE	∅	RAL	
C16VD	16 mm	RAL 7035	50
C20VD	20 mm	RAL 7035	50
C25VD	25 mm	RAL 7035	5
C32VD	32 mm	RAL 7035	5
C40VD	40 mm	RAL 7035	5
C50VD	50 mm	RAL 7035	3
C16VD R	16 mm	RAL 7037	50
C20VD R	20 mm	RAL 7037	50
C25VD R	25 mm	RAL 7037	5
C32VD R	32 mm	RAL 7037	5
C40VD R	40 mm	RAL 7037	5
C50VD R	50 mm	RAL 7037	3

Light Grey = RAL 7035

R = Dark Grey = RAL 7037



PVC BUIZEN EN TOEBEHOREN TUBES PVC ET ACCESSOIRES

Eindtullen voor rechte PVC buis
Embouts pour conduite rigide en PVC



BESTELNUMMER N° DE COMMANDE	∅	RAL	
EC16	16 mm	RAL 7035	100/7000
EC20	20 mm	RAL 7035	100/5500
EC25	25 mm	RAL 7035	50/2500
EC16 R	16 mm	RAL 7037	100/7000
EC20 R	20 mm	RAL 7037	100/5500
EC25 R	25 mm	RAL 7037	50/2500

Light Grey = RAL 7035
R = Dark Grey = RAL 7037



Invoertule M20
Entrées tube M20



BESTELNUMMER N° DE COMMANDE	∅	
MIBR1620	16 & 20 mm	50/2000

Light Grey = RAL 7035



Metalen buizen, zonder schroefdraad - Galvanisch verzinkt
Tubes en métal, sans filetage - Galvanisé



BESTELNUMMER N° DE COMMANDE	Afm. Dim.	
010TARM016	M16 x 1,5	3 m/51 m
010TARM020	M20 x 1,5	3 m/30 m
010TARM025	M25 x 1,5	3 m/30 m
010TARM032	M32 x 1,5	3 m/21 m
010TARM040	M40 x 1,5	3 m/15 m
010TARM050	M50 x 1,5	3 m/15 m
010TARM063	M63 x 1,5	3 m/9 m

Conform EN 61386 21 - code 5557
OP BESTELLING / SUR COMMANDE : INOX

PVC BUIZEN EN TOEBEHOREN TUBES PVC ET ACCESSOIRES

Metalen bochten, zonder schroefdraad - Galvanisch verzinkt

Coudes en métal 90°, sans filetage - Galvanisé



BESTELNUMMER N° DE COMMANDE	∅	
020CARM016	M16	10
020CARM020	M20	10
020CARM025	M25	10
020CARM032	M32	10
020CARM040	M40	5
020CARM050	M50	5
020CARM063	M63	5

Conform EN 61386 21 - code 5557

OP BESTELLING / SUR COMMANDE : INOX

Koppelstukken, zonder schroefdraad - Galvanisch verzinkt

Manchons sans filetage - Galvanisé



BESTELNUMMER N° DE COMMANDE	∅	
020MARM016	M16 - L45 mm	100
020MARM020	M20 - L50 mm	100
020MARM025	M25 - L55 mm	60
020MARM032	M32 - L65 mm	30
020MARM040	M40 - L70 mm	25
020MARM050	M50 - L90 mm	12
020MARM063	M63 - L105 mm	6

Conform EN 61386 21 - code 5557

OP BESTELLING / SUR COMMANDE : INOX

BLACK & WHITE BLACK & WHITE

Rechte buis
Tube rigide



BESTELNUMMER N° DE COMMANDE	Afm. Dim.	
VD20 Black	20 mm	111m
VD20 White	20 mm	111m
VD20 Black-2M	20 mm	30m*
VD20 White-2M	20 mm	30m*

Lengte / Longueur: 3m
*Lengte / Longueur: 2m
White = RAL 9003
Black = RAL 9004

Veerklem Black & White
Attache ressort Black & White



BESTELNUMMER N° DE COMMANDE	Afm. Dim.	
204 White	20 mm	100 / 2000
204 Black	20 mm	100 / 2000
208 BLACK	25 mm	50 / 1500

White = RAL 9003
Black = RAL 9004



Buisinvoer
Entrée tube



BESTELNUMMER N° DE COMMANDE	Afm. Dim.	
MIBR Black	16/20 mm	50 / 2000
MIBR White	16/20 mm	50 / 2000

White = RAL 9003
Black = RAL 9004



PVC Stop
Bouchon PVC



BESTELNUMMER N° DE COMMANDE	Afm. Dim.	
907M20 Black	20 mm	50 / 2000

Black = RAL 9004



BLACK & WHITE BLACK & WHITE

Wartel
Presse-étoupe



BESTELNUMMER N° DE COMMANDE	Afm. Dim.	
BM20 White	20 mm	50 / 2000
BM20 Black	20 mm	50 / 2000

White = RAL 9003
Black = RAL 9004



Mof
Manchon



BESTELNUMMER N° DE COMMANDE	Afm. Dim.	
U408 White	20 mm	50 / 1600
U408 Black	20 mm	100 / 1600
U409 Black	25 mm	25

White = RAL 9003
Black = RAL 9004



Aaneenschuifbare drukklemmen
Attaches à pression à juxtaposer



BESTELNUMMER N° DE COMMANDE	Afm. Dim.	
2036 Black	12 - 20 mm	50 / 1500
2037 Black	16 - 24 mm	50 / 1500

Black = RAL 9004



Boxline kabeldoos schroefingangen M20
Boxline boîte de dérivation filetage M20



BESTELNUMMER N° DE COMMANDE	Ingangen Entrées	ø	Afm. Dim.	
J100S Black	7	M20	102²x56 mm	1 / 90
J100S White	7	M20	102²x56 mm	1 / 90

White = RAL 9003
Black = RAL 9004



BLACK & WHITE BLACK & WHITE

Kabeldoos thermoplast

Boîte de dérivation thermoplastique



BESTELNUMMER N° DE COMMANDE	Ingangen Entrées	Afm. Dim.	
FE25 Black		89 x 43 x 37 mm	10 / 150
FE25 White		89 x 43 x 37 mm	10 / 150
FE7 BLACK	7	75x75x37	10/300

Black = RAL 9004
White = RAL 9010
ø 1,5-4mm



Eindstuk

Embout



BESTELNUMMER N° DE COMMANDE	Afm. Dim.	
EC20 Black	20 mm	100 / 2000
EC20 White	20 mm	100 / 2000

Black = RAL 9004
White = RAL 9010



Nagelclips - Platte Kabel - Wit

Attaches à clouer - câble plat - Blanc



BESTELNUMMER N° DE COMMANDE	ø	
702-2W	2 x 1,5	100
702-3W	2 x 2,5	100

* Ook Beschikbaar in Witte kleur

* Aussi disponible en Blanc



BLACK & WHITE BLACK & WHITE

Nagelclips - maten in mm

Attaches en clouer - mesures en mm



BESTELNUMMER N° DE COMMANDE	∅	
3007-18BLACK	7 mm*	100 /12800

De 2 laatste cijfers van het bestelnummer duiden de lengte van de nagel aan. Kleur: Grijs

Les 2 derniers chiffres du n° de commande indiquent la longueur du clou. Couleur: Gris

*Zwart / Noire



WARTELS PRESSE-ETOUPES

Wartels - Pg reeks

Presse-étoupes - Série Pg



BESTELNUMMER N° DE COMMANDE	∅	
90507	PG7	50
90509	PG9	50 / 3750
90511	PG11	50 / 2700
90513	PG13,5	50 / 2700
90516	PG16	50 / 1850
90521	PG21	20 / 1080
90529	PG29	20 / 440
90536	PG36	10 / 220
90548	PG48	5

Polystyrol

Schokbestendig / Résistant au choc

Wurgring in rubber / Bague d'échanchéité en caoutchouc

Drukrondel in gegalvaniseerd ijzer / Rondelle de pression en acier galvanisé

IP 65 – 5°C à + 60°C



Wartels met trekontlasting - Pg reeks

Presse-étoupes à serrage - Série Pg



BESTELNUMMER N° DE COMMANDE	∅	
9707-ORL01	PG7	100
9709-ORL02	PG9	100
9711-ORL03	PG11	100
9713-ORL04	PG13,5	100
9716-ORL05	PG16	50
9721-ORL06	PG21	50
9729-ORL07	PG29	25
9736-ORL08	PG36	10
9748-ORL10	PG48	5

Polyamide met TPE rubber / Bague TPE

IP 68 –30°C à + 80°C



WARTELS PRESSE-ETOUPES

Tegenmoeren - Pg reeks
 Contre-écrous - Série Pg



BESTELNUMMER N° DE COMMANDE	Ø	
90607	PG7	50
90609	PG9	50
90611	PG11	50
90613	PG13,5	50 / 5600
90616	PG16	50 / 5600
90621	PG21	20 / 2240
90629	PG29	20 / 2240
90636	PG36	10
90648	PG48	10

Polystyrol / Polystyrene
 Schokbestendig / Résistant au choc
 - 5°C à + 60°C
 DIN 46320 - L



Stoppen - Pg reeks
 Bouchons - Série Pg



BESTELNUMMER N° DE COMMANDE	Ø	
90707	PG7	100
90709	PG9	100
90711	PG11	100
90713	PG13,5	50
90716	PG16	50
90721	PG21	50
90729	PG29	50
90736	PG36	50
90748	PG48	25

Polystyrol / Polystyrene
 Schokbestendig / Résistant au choc
 - 5°C à + 60°C
 DIN 46320 - N



WARTELS PRESSE-ETOUPES

Wartels - Metrische reeks

Presse-étoupes - Série Métrique IP54



BESTELNUMMER N° DE COMMANDE	∅	
905M12-DMRL01	12 mm	50
905M16-DMRL03	16 mm	50
905M20-DMRL04	20 mm	100
905M25-DMRL06	25 mm	50

Polyamide / IP 54 / -30°C / +80°C,
TPV Rubber / Bague TPV, EN60423



Wartels met trekontlasting - Metrische reeks IP68

Presse-étoupes à serrage - Série Métrique IP68



BESTELNUMMER N° DE COMMANDE	∅	
BM12	12 mm	50 / 2000
BM16	16 mm	50 / 2000
BM20	20 mm	50 / 2000
BM25	25 mm	20 / 800
BM32	32 mm	20 / 600
BM40	40 mm	10 / 300
BM50	50 mm	5 / 200
BM63	63 mm	5 / 120

Met skintop en trekontlasting
Avec skintop et serrage étendu
Polyamide / IP 68 / -20°C / +125°C



Wartels MULTIHOLE met trekontlasting - Metrische reeks IP65

Presse-étoupes MULTIHOLE à serrage - Série Métrique IP6

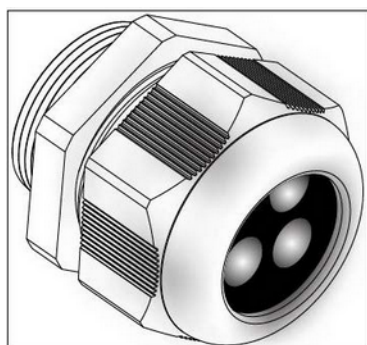

BESTELNUMMER N° DE COMMANDE	∅	RAL
OMRL05A7	M20	RAL7035

IP65, -30°C / +80°C, RAL7035



WARTELS PRESSE-ETOUPES

Wartels met trekontlasting
 Presse-étoupes à serrage - Série Métrique



BESTELNUMMER N° DE COMMANDE	∅	
OMRL03 M16	M16 (5-10 mm)	150 / 2500
OMRL05 M20	M20 (10-14 mm)	150 / 2500
OMRL09 M50	M50	100 / 1600
OMRL10 M63	M63	100 / 1600

Polyamide / IP 68
 -30°C / +80°C,
 TPV Rubber / Bague TPV, EN50262, RAL7035, VDE
 RAL7035
 Einde Reeks/Fin de série



Tegenmoeren - Metrische reeks
 Contre-écrous - Série Métrique



BESTELNUMMER N° DE COMMANDE	∅	
PM12	12 mm	100
PM16	16 mm	50
PM20	20 mm	50 / 5600
PM25	25 mm	20 / 2240
PM32	32 mm	20
PM40	40 mm	20
PM50	50 MM	10
PM63	63 MM	5

Polyamide
 RAL7035
 - 20°C / +125°C



Tegenmoeren - Metrische reeks
 Contre-écrous - Série Métrique



BESTELNUMMER N° DE COMMANDE	∅
OMSL01	12 mm
OMSL02	16 mm
OMSL03	20 mm
OMSL04	25 mm
OMSL05	32 mm

Polyamide (30% Glassfiber)
 RAL7035
 - 30°C / +80°C



WARTELS PRESSE-ETOUPES

Tegenmoeren - Metrische reeks
 Contre-écrous - Série Métrique



BESTELNUMMER N° DE COMMANDE	∅
OMSL06	40 mm
OMSL07	50 mm
OMSL08	63 mm

Polyamide (30% Glassfiber)
 RAL7035
 - 30°C / +80°C



Stoppen - Metrische reeks
 Bouchons - Série Métrique



BESTELNUMMER N° DE COMMANDE	∅	
907M12	12 mm	100
907M16	16 mm	100
907M20	20 mm	100
907M25	25 mm	25
907M32	32 mm	20
907M40	40 mm	10
907M50	50 mm	4
907M63	63 mm	4

Polyamide
 RAL7035
 - 30°C / +80°C



Wurgnippels - Metrische reeks
 Raccords à visser - Série Métrique



BESTELNUMMER N° DE COMMANDE	∅	
908M16	16 mm	100
908M20	20 mm	100
908M25	25 mm	100
908M32	32 mm	50
908M40	40 mm	25
908M50	50 mm	10
908M63	63 mm	10

Polyamide
 RAL7035
 - 30°C / +80°C



WARTELS PRESSE-ETOUPES

Drukmoeren - Metrische reeks

Boulons de pression - Série Métrique



BESTELNUMMER N° DE COMMANDE	∅
909M16	16 mm
909M20	20 mm



Vergrotingen - Metrische reeks

Augmentations - Série Métrique



BESTELNUMMER N° DE COMMANDE	∅ IN	∅	
ME1216	M16	M12	100
ME1620	M20	M16	100
ME2025	M25	M20	100
ME2532	M32	M25	50
ME3240	M40	M32	50

Polystyrol / IP 65 / - 5°C / + 60°C



Verkleiningen - Metrische reeks

Réductions - Série Métrique



BESTELNUMMER N° DE COMMANDE	∅ IN	∅	
MR1612	M12	M16	100
MR2012	M12	M20	100
MR2016	M16	M20	100
MR2512	M12	M25	100
MR2516	M16	M25	100
MR2520	M20	M25	100
MR3212	M12	M32	50
MR3216	M16	M32	50
MR3220	M20	M32	50
MR3225	M25	M32	50
MR4016	M16	M40	50
MR4020	M20	M40	50
MR4025	M25	M40	50
MR4032	M32	M40	50
MR5020	M20	M50	25



WARTELS PRESSE-ETOUPES

Verkleiningen - Metrische reeks

Réductions - Série Métrique



BESTELNUMMER N° DE COMMANDE	ø IN	ø	
MR5025	M25	M50	25
MR5032	M32	M50	25
MR5040	M40	M50	25
MR6325	M25	M63	25
MR6332	M32	M63	25
MR6340	M40	M63	25
MR6350	M50	M63	25



Wartels Messing met trekontlasting - Metrische reeks

Presse-étoupes Laiton nickelé à serrage - Métrique



BESTELNUMMER N° DE COMMANDE	ø	
OMBG01	12 mm	20 / 100
OMBG02	16 mm	20 / 100
OMBG03	20 mm	20 / 100
OMBG04	25 mm	20 / 100
OMBG05	32 mm	10 / 100
OMBG06	40 mm	10 / 100
OMBG07	50 mm	5 / 50
OMBG08	63 mm	1 / 10

Messing / Laiton nickelé

IP 68

-40°C à +100°C, TPV Rubber / Bague TPV

EN60423

Tegenmoeren Messing - Metrische reeks

Contre-écrous Laiton nickelé - Série Métrique



BESTELNUMMER N° DE COMMANDE	ø	
OMBL01	12 mm	20 / 100
OMBL02	16 mm	20 / 100
OMBL03	20 mm	20 / 100
OMBL04	25 mm	20 / 100
OMBL05	32 mm	10 / 100
OMBL06	40 mm	10 / 100
OMBL07	50 mm	5 / 50
OMBL08	63 mm	1 / 10

Messing / Laiton nickelé

EN60423

KLEMMEN ATTACHES

veerklemmen
Attaches ressort



BESTELNUMMER N° DE COMMANDE	∅	
108	50 mm	25 / 600

M6 Polyamide
Kleur : grijs
Couleur : gris



Aaneenschuifbare veerklemmen
Attaches ressort à juxtaposer



BESTELNUMMER N° DE COMMANDE	∅	
211	16 mm	100 / 4000
204	20 mm	100 / 3000
208	25 mm	50 / 1500
209	32 mm	50 / 1500
210	40 mm	25 / 750

M6 Polyamide
Kleur : grijs
Couleur : gris



Aaneenschuifbare drukklemmen
Attaches pression à juxtaposer



BESTELNUMMER N° DE COMMANDE	∅	
2035	6 - 13 mm	50 / 3750
2036	12 - 20 mm	50 / 1500
2037	16 - 24 mm	50 / 1500
2038	18 - 30 mm	50 / 1200
2039	27 - 43 mm	25 / 750

M6 Polyamide
Kleur : grijs
Couleur : gris



KLEMMEN ATTACHES

Universele klemmen
Attaches universelles





BESTELNUMMER N° DE COMMANDE	∅	
031G	16 - 22 mm	50 / 2700
031T	16 - 22 mm	50 / 2700

Kleur : Grijs of transparant
Couleur : Gris ou transparent

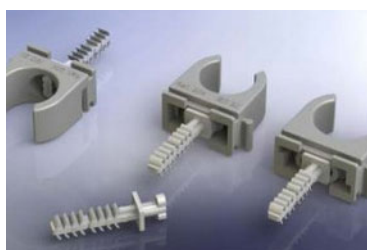

Veerklem met Plug M6
Attache Ressort avec Cheville M6



BESTELNUMMER N° DE COMMANDE	∅	
204 D	16 mm	50/2000
211 D	20 mm	100/4000

M6 Polyamide
Kleur : grijs
Couleur : gris



Drukklem met Plug M6
Attaches pression avec Cheville M6



BESTELNUMMER N° DE COMMANDE	∅	
2036 D	12 - 20 mm	50 / 1500
2037 D	16 - 24 mm	50 / 1200

M6 Polyamide
Kleur : grijs
Couleur : gris



Plug M6 voor veer- en drukklemmen
Cheville M6 pour attaches ressort et à pression



BESTELNUMMER N° DE COMMANDE	
20436	100

M6 Polyamide
Kleur : grijs
Couleur : gris



KLEMMEN ATTACHES

Vorkklemmen Attaches fourchette



BESTELNUMMER N° DE COMMANDE	∅	
512	10 mm	100
513	12 mm	100
515	14 - 15 mm	100
516	16 - 18 mm	50/2500
517	20 - 22 mm	50/2500
518	22 - 25 mm	50/2700
519	35 mm	20
520	42 mm	25

M6 Polyamide
Grijs / gris



Vorkklemmen dubbel Attaches fourchette double



BESTELNUMMER N° DE COMMANDE	∅	
512-2	10 mm	50
513-2	12 mm	50
515-2	14 - 15 mm	50
516-2	16 - 18 mm	25/1350
517-2	20 - 22 mm	25/1350
518-2	25 - 28 mm	25

Voor gelijktijdige bevestiging van 2 kabels of buizen
Pour fixation simultane de 2 cables ou tubes
M6 Polyamide
Grijs / gris



KZM kabelzadels KZM attaches



BESTELNUMMER N° DE COMMANDE	∅	
905	5 - 14 mm	100/4000
906	6 - 17 mm	50/2000
907	15 - 25 mm	50/1200
908	24 - 34 mm	25/750

Polypropyleen/Polypropylène
Vijs in polystyrol/Vis en polystyrol



KLEMMEN ATTACHES

KZM kabelzadels dubbel
KZM attaches double



BESTELNUMMER N° DE COMMANDE	∅	
906-2	6 - 17 mm	50/1500

Polypropyleen/Polypropylène
Vijs in polystyrol/Vis en polystyrol



Saniclips M6
Saniclips M6



BESTELNUMMER N° DE COMMANDE	∅	
M512	12 mm	100
M515	14/15 mm	100
M518	16/18 mm	100
M522	20/22 mm	100
M512-2	2x12 mm	100
M515-2	2x14/15 mm	100
M518-2	2x16/18 mm	100
M522-2	2x20/22 mm	100



Slagklemmen
Attaches intercalaires



BESTELNUMMER N° DE COMMANDE	∅	
2047	5 - 25 mm	100 / 5400
2048	8 - 38 mm	100 / 3000

Snelle montage voor rail 761 & 2761
Fixation rapide pour rail 761 & 2761



KLEMMEN ATTACHES

Kabelhouder Attaches câble

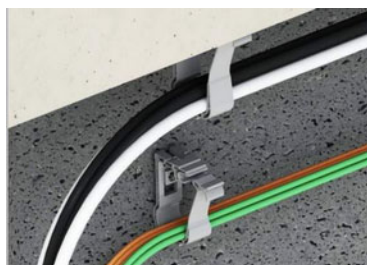

BESTELNUMMER N° DE COMMANDE	Normes	Afm. Dim.
710-15	Max. 10kg	38x69 mm
710-30	Max. 10kg	42x106 mm



Railklemmen Attaches pour rail avec vis



BESTELNUMMER N° DE COMMANDE	∅	
2050	7 - 25 mm	100 / 5400
2051	13 - 38 mm	100 / 3000

Voor rail 761 & 2761
Pour rail 761 & 2761



Aaneenschuifbare 'Clic' klemmen Attaches 'Clic' à juxtaposer



BESTELNUMMER N° DE COMMANDE	∅	
701516	15 - 16 mm	50
701920	20 - 22 mm	50
702225	25 - 28 mm	50
703235	32 - 35 mm	50



Klembeugels "Marine" Attaches "Marine"



BESTELNUMMER N° DE COMMANDE	∅	
9700012	12 mm	300 / 1200
9700016	16 mm	250 / 1000
9700020	20 mm	200 / 800
9700025	25 mm	150 / 600
9700028	28 mm	125 / 500

Afmetingen / Dimensions : 20 x 1,25 mm
Gat / Trou : 5 mm

KLEMMEN ATTACHES

Klembeugels "Speed" Enkel
Attaches "Speed" Simple



BESTELNUMMER N° DE COMMANDE	∅	
9701016	16 mm	250 / 1000
9701020	20 mm	175 / 700
9701025	25 mm	150 / 600

Schietbeugel
Attache pour tirer

Klembeugels "Speed" dubbel
Attaches "Speed" double



BESTELNUMMER N° DE COMMANDE	∅	
9700316	2 x 16 mm	100 / 400
9700320	2 x 20 mm	75 / 300
9700325	2 x 25 mm	50 / 200

Schietbeugel
Attache pour tirer

IJzeren inslagbeugel
Attache à frapper en métal



BESTELNUMMER N° DE COMMANDE	∅	
9100900	16 - 20 mm	500 / 2000

IJzeren zadels - rood gelakt
Attaches en acier - rouge laquée



BESTELNUMMER N° DE COMMANDE	∅	
9100001	16 mm	500 / 2000
9100002	20 mm	350 / 1400
9100004	25 mm	150 / 600
9100005	32 mm	100 / 400
9100026	40 mm	75 / 300
9100007	50 mm	50 / 200
9100029	2 x 16 mm	250 / 1000
9100030	3 x 16 mm	200 / 800

KLEMMEN ATTACHES

IJzeren zadels - rood gelakt
 Attaches en acier - rouge laquée



BESTELNUMMER N° DE COMMANDE	∅	
9100031	4 x 16 mm	150 / 600
9100066	2 x 20 mm	200 / 800
9100067	3 x 20 mm	150 / 600

IJzeren zadels - verzinkt
 Attaches en acier - galvanisé



BESTELNUMMER N° DE COMMANDE	∅	
9100116	16 mm	500 / 2000
9100120	20 mm	350 / 1400
9100126	25 mm	150 / 600
9100132	32 mm	100 / 400
9100140	40 mm	75 / 300
9100150	50 mm	50 / 200
9100037	2 x 16 mm	250 / 1000
9100038	3 x 16 mm	200 / 800
9100707	4 x 16 mm	150 / 600
9100046	2 x 20 mm	200 / 800
9100047	3 x 20 mm	150 / 600

Zadels enkel pad - gegalvaniseerd
 Attaches simple patte - galvanisé



BESTELNUMMER N° DE COMMANDE	∅	
9700916	16 mm	500 / 2000
9700920	20 mm	350 / 1400
9700925	25 mm	150 / 600

KLEMMEN ATTACHES

Zadels in U-vorm - rood gelakt

Attaches en forme U - rouge laquée



BESTELNUMMER N° DE COMMANDE	∅	
9100056	16 mm	500 / 2000
9100057	20 mm	350 / 1400
9100903	25 mm	150 / 600

FUNCTIEBEHOUD MAINTIEN DE FONCTION

FBB beugel, inclusief schroefanker - E90

Attache, cheville à visser incluse - E90



BESTELNUMMER N° DE COMMANDE	∅	
9700806	6 mm	200 / 800
9700808	8 mm	200 / 800
9700810	10 mm	200 / 800
9700812	12 mm	200 / 800
9700814	14 mm	150 / 600
9700816	16 mm	150 / 600
9700819	19 mm	150 / 600
9700825	25 mm	100 / 400
9702816	16 mm	75/300
9702819	19 mm	75/300
9700850	*1	
9700855	*2	
9700860	*3	

Per verpakking een SDS boor (torx bitje) inclusief

*1 Schroefanker - TSM

*2 Schroefbit - Torx 25 - 1 /4"

*3 SDS functiebehoudboor - dia. 5x110

Une mèche SDS (torx) incluse par emballage

*1 Vis maintien de fonction - TSM

*2 nr 25 Embout de vissage - Torx 25 - 1/4"

*3 Mèche SDS - dia. 5x110



FBB beugel, inclusief inslaganker - E90

Attache, cheville à frapper incluse - E90



BESTELNUMMER N° DE COMMANDE	∅	
9700826	6 mm	200 / 800
9700828	8 mm	200 / 800
9700830	10 mm	200 / 800
9700832	12 mm	200 / 800
9700834	14 mm	150 / 600
9700836	16 mm	150 / 600
9700839	19 mm	150 / 600
9700845	25 mm	100 / 400
9702836	16 mm	75/300
9702839	19 mm	75/300

*1 SDS functiebehoudboor - dia. 6x110

*2 Inslaganker TDN 6/35

*1 Mèche SDS - dia. 6x110

*2 Cheville à frapper maintien de fonction TDN 6/35



FUNCTIEBEHOUD MAINTIEN DE FONCTION

FBB beugel, inclusief inslaganker - E90
 Attache, cheville à frapper incluse - E90



BESTELNUMMER N° DE COMMANDE	∅
9700880	*2
9700875	*1

- *1 SDS functiebehoudboor - dia. 6x110
- *2 Inslaganker TDN 6/35
- *1 Mèche SDS - dia. 6x110
- *2 Cheville à frapper maintien de fonction TDN 6/35



FBB Beugel en Duim Nagel
 Attache + cheville a Pousser maintien de fonction



BESTELNUMMER N° DE COMMANDE	Omschrijving	Description	∅	
9700817	Enkel	Simple	16 mm	150/ 600
9700820	Enkel	Simple	19 mm	150/ 600
9702817	Dubbel	Double	16 mm	150/ 600
9702820	Dubbel	Double	19 mm	150/ 600



Klem voor buis en kabel met eenzijdige schuifbare sluiting
 Collier pour câble et tube-fermeture unilatérale coulissant



BESTELNUMMER N° DE COMMANDE	∅	
5605-16	14-18 mm	100
5605-22	19-23 mm	75
5605-28	24-28 mm	50
5605-38	30-38 mm	40
5605-50	39-52 mm	30
5605-60	53-61 mm	20

E90 (volgens/selon DIN 4102-12)
 OP BESTELLING / SUR COMMANDE : INOX



PROFIELKLEMMEN ATTACHES POUR PROFILES

Clipsen

Clips



BESTELNUMMER N° DE COMMANDE	Oud Ref. Ancienne réf.	Dikte profiel Epaisseur profile	
FH4-DT	SI100DT	1,5 - 4 mm	100
FH10-DT	SI101DT	4 - 10 mm	100
FH15-DT	SI102DT	10 - 15 mm	100
FH20-DT	SI103DT	15 - 20 mm	100

Voor draadstang

Pour tiges filetées



BESTELNUMMER N° DE COMMANDE	Oud Ref. Ancienne réf.	Dikte profiel Epaisseur profile	
FH20-ICA10DT	SI103-212DT	15 - 20 mm / M10	100
FH15-ICA10DT	SI102-212DT	10 - 15 mm / M10	100
FH4-ICA8DT	SI100-211DT	1,5 - 4 mm / M8	100
FH15-ICA8DT	SI102-211DT	10 - 15 mm / M8	100
FH20-ICA6DT	SI103-210DT	15 - 20 mm / M6	100
FH20-ICA8DT	SI103-211DT	15 - 20 mm / M8	100
FH10-ICA8DT	SI101-211DT	4 - 10 mm / M8	100
FH10-ICA6DT	SI101-210DT	4 - 10 mm / M6	100
FH15-ICA6DT	SI102-210DT	10 - 15 mm / M6	100
FH4-ICA6DT	SI100-210DT	1,5 - 4 mm / M6	100
FH4-ICA10DT	SI100-212DT	1,5 - 4 mm / M10	100
FH10-ICA10DT	SI101-212DT	4 - 10 mm / M10	100

PROFIELKLEMMEN ATTACHES POUR PROFILES

Voor kabelbinder
Pour Collier de Câblage



BESTELNUMMER N° DE COMMANDE	Oud Ref. Ancienne réf.	Dikte profiel Epaisseur profile	
FH20-BRDT	SI103-250DT	15 - 20 mm	100
FH15-BRDT	SI102-250DT	10 - 15 mm	100
FH10-BRDT	SI101-250DT	4 - 10 mm	100
FH4-BRDT	SI100-250DT	1,5 - 4 mm	100

Klem - M6x9
Attache - M6x9



BESTELNUMMER N° DE COMMANDE	Oud Ref. Ancienne réf.	Dikte profiel Epaisseur profile	
FU7TM6DT	SI104TM6DT	3 - 7 mm	100
FU12-5TM6DT	SI105TM6DT	7 - 13 mm	100
FU20TM6DT	SI106TM6DT	14 - 20 mm	100

Klem - M8x14
Attache - M8x14



BESTELNUMMER N° DE COMMANDE	Oud Ref. Ancienne réf.	Dikte profiel Epaisseur profile	
FU7TM8DT	SI104TM8DT	3 - 7 mm	100
FU12-5TM8DT	SI105TM8DT	7 - 13 mm	100
FU20TM8DT	SI106TM8DT	14 - 20 mm	100

Klem - M8x14 Zonder Schroef
Attache - M8x14 sans vis



BESTELNUMMER N° DE COMMANDE	Oud Ref. Ancienne réf.	Dikte profiel Epaisseur profile	
FU7DT	SI104DT	3 - 7 mm	100
FU12-5DT	SI105DT	7 - 13 mm	100
FU20DT	SI106DT	14 - 20 mm	100

PROFIELKLEMMEN ATTACHES POUR PROFILES

Klem
Attache

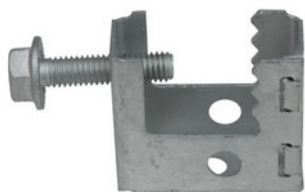

BESTELNUMMER N° DE COMMANDE	Oud Ref. Ancienne réf.	Dikte profiel Epaisseur profile	
SB17-11DT	SI130DT	max. 16 mm	100

CLIPS
CLIPS



BESTELNUMMER N° DE COMMANDE	Oud Ref. Ancienne réf.	ø	Dikte profiel Epaisseur profile	
CD4-9DT	SI306DT	8 - 9 mm	1 - 4 mm	100
CD7-5-9DT	SI307DT	8 - 9 mm	4 - 7,5 mm	100
CD12-9DT	SI307.2DT	8 - 9 mm	7,5 - 12 mm	100
CD4-11DT	SI308DT	10 - 11 mm	1 - 4 mm	100
CD7-5-11DT	SI309DT	10 - 11 mm	4 - 7,5 mm	100
CD12-11DT	SI309.2DT	10 - 11 mm	7,5 - 12 mm	100
CD4-14DT	SI310DT	12 - 14 mm	1 - 4 mm	100
CD7-5-14DT	SI311DT	12 - 14 mm	4 - 7,5 mm	100
CD12-14DT	SI311.2DT	12 - 14 mm	7,5 - 12 mm	100
CD4-18DT	SI312DT	15 - 18 mm	1 - 4 mm	100
CD7-5-18DT	SI313DT	15 - 18 mm	4 - 7,5 mm	100
CD12-18DT	SI313.2DT	15 - 18 mm	7,5 - 12 mm	100
CD4-24DT	SI314DT	19 - 24 mm	1 - 4 mm	100
CD7-5-24DT	SI315DT	19 - 24 mm	4 - 7,5 mm	100
CD12-24DT	SI315.2DT	19 - 24 mm	7,5 - 12 mm	100
CD4-30DT	SI316DT	25 - 30 mm	1 - 4 mm	100
CD7-5-30DT	SI317DT	25 - 30 mm	4 - 7,5 mm	100

PROFIELKLEMMEN ATTACHES POUR PROFILES

CLIPS
CLIPS



BESTELNUMMER N° DE COMMANDE	Oud Ref. Ancienne réf.	∅	Dikte profiel Epaisseur profile	
CD12-30DT	SI317.2DT	25 - 30 mm	7,5 - 12 mm	100

Rapid RTB dakplaathanger V model
Attache RTB pour plaque de toit en V



BESTELNUMMER N° DE COMMANDE	Afm. Dim.	Dikte profiel Epaisseur profile	
9004121	M8 / M10	0.63 mm	50

TYPE RTB 8/10

Ponstang
Poinçon pour plaque de toit en V



BESTELNUMMER N° DE COMMANDE	
9004510	1

ISOLATIETAPE RUBAN ISOLANT

Isolatietape 0,15 mm x 19 mm x 20 m

Ruban isolant 0,15 mm x 19 mm x 20 m



BESTELNUMMER N° DE COMMANDE	KLEUR	COULEUR	
TP151920BK	zwart	noir	10 / 250
TP151920BL	blauw	bleu	10 / 250
TP151920BN	bruin	brun	10 / 250
TP151920GRN	groen	vert	10 / 250
TP151920GY	groen-geel	vert-jaune	10 / 250
TP151920RD	rood	rouge	10 / 250
TP151920WT	wit	blanc	10 / 250
TP151920YL	geel	jaune	10 / 250
TP151920GR	grijs	gris	10 / 250

Vlamvertragend BSEN 60454-2

Flame retardant BSEN 60454-2

Isolatietape 0,15 mm x 50 mm x 20 m

Ruban isolant 0,15 mm x 50 mm x 20 m



BESTELNUMMER N° DE COMMANDE	KLEUR	COULEUR	
TP155020BK	zwart	noir	1 / 100
TP155020RD	rood	rouge	1 / 100
TP155020YL	geel	jaune	1 / 100

Vlamvertragend BSEN 60454-2

Flame retardant BSEN 60454-2

TOT UITPUTTING VAN DE STOCK / JUSQU'À ÉPUISEMENT DU STOCK

SNELMONTAGE FIXATION RAPIDE

Universele nagelclips

Clips à clouer universels



BESTELNUMMER N° DE COMMANDE	∅	
700-02	2,5 - 4 mm	100 /12800
700-05	5 - 7 mm	100 /12800
700-08	8 - 10 mm	100 /9600
700-11	11 - 15 mm	100 /7500
700-16	16 - 19 mm	50 /500
700-23	23 - 29 mm	50 /250
700-08 BLACK	5 - 7 mm *	100 /9600

Met slechts 6 types alle maten in voorraad. Kleur: Grijs
Avec seulement 6 types toutes dimensions en stock. Couleur: Gris

* Black



Nagelclips - maten in mm

Attaches en clouer - mesures en mm



BESTELNUMMER N° DE COMMANDE	∅	
3004-18	4 mm	100 /12800
3005-18	5 mm	100 /12800
3006-18	6 mm	100 /12800
3007-18	7 mm	100 /12800
3008-20	8 mm	100 /12800
3009-20	9 mm	100 /12800
3010-35	10 mm	100 /12800
3011-35	11 mm	100 /12800
3012-35	12 mm	50 / 6400
3014-40	14 mm	50 / 5400
3016-40	16 mm	25 / 3250
3018-40	18 mm	25 / 3200
3020-40	20 mm	25 / 3200
3007-18BLACK	7 mm*	100 /12800

De 2 laatste cijfers van het bestelnummer duiden de lengte van de nagel aan. Kleur: Grijs

Les 2 derniers chiffres du n° de commande indiquent la longueur du clou. Couleur: Gris

*Zwart / Noire



SNELMONTAGE FIXATION RAPIDE

Nagelclips - maten in mm

Attaches à clouer - mesures en mm



BESTELNUMMER N° DE COMMANDE	ø IN	
OL70211	3/4 mm	100 /10000
OL70212	5/6 mm	100 /10000
OL70213	7/8 mm	100 /10000
OL70214	9/10 mm	100 /10000
OL70215	11/12 mm	100 /10000
OL70216	13/14 mm	100 /5000
OL70217	15/16 mm	100 /4000
OL70218	17/18 mm	100 /3000

De 2 laatste cijfers van het bestelnummer duiden de lengte van de nagel aan. Kleur: Grijs

Les 2 derniers chiffres du n° de commande indiquent la longueur du clou. Couleur: Gris



Nagelclips - Platte Kabel

Attaches à clouer - câble plat



BESTELNUMMER N° DE COMMANDE	ø	
702-0	2 x 0,75	100 /2000
702-1	2 x 1	100 /2000
702-2	2 x 1,5	100 /1000
702-3	2 x 2,5	100 /1000

* Ook Beschikbaar in Witte kleur

* Aussi disponible en Blanc



Plugclips met nagel

Clips cheville avec clou



BESTELNUMMER N° DE COMMANDE	ø	
300620W	16 - 19 mm	200 / 3200
300720W	16 - 19 mm	100 / 1600



SNELMONTAGE FIXATION RAPIDE

Enkel
Simple



BESTELNUMMER N° DE COMMANDE	Ingangen Entrées	∅	
601620	1	16 - 20 mm	200 / 6000
601922	1	19 - 22 mm	125 / 3750
602125	1	21 - 25 mm	125 / 3750

Snelle betonmontage / Fixation beton rapide
Kleur : wit / Couleur : blanc



Dubbel
Double



BESTELNUMMER N° DE COMMANDE	Ingangen Entrées	∅	
611620	2	16 - 20 mm	125 / 3750
611922	2	19 - 22 mm	75 / 2250
612125	2	21 - 25 mm	60 / 1800

Snelle betonmontage / Fixation beton rapide
Kleur : wit / Couleur : blanc



Plugclip in PVC - dubbel
Clip cheville en PVC - double



BESTELNUMMER N° DE COMMANDE	Ingangen Entrées	∅	
411620	2	16 - 20 mm	120 / 3600

Snelle betonmontage / Fixation beton rapide
Kleur : wit / Couleur : blanc



Pluggen
Chevilles



BESTELNUMMER N° DE COMMANDE	∅	
SEL712006	6 mm	100 / 4000
SEL712008	8 mm	100 / 2500
SEL712010	10 mm	50 / 1250
SEL712012	12 mm	25 / 625

SNELMONTAGE FIXATION RAPIDE

High cavity pluggen
Chevilles à haute traction



BESTELNUMMER N° DE COMMANDE	∅	
SELRXO101	6 x 35 mm	100 / 1800
SELRXO102	8 x 50 mm	50 / 900

High cavity pluggen / Chevilles à haute traction

Nylon plug voor gipsplaten
Cheville Nylon pour plaques de plâtre



BESTELNUMMER N° DE COMMANDE	∅	
SELCOGO101	12,3 x 29 mm	100 / 4000

Nylon plug met houtvijs kruis
Cheville Nylon avec visse en croix



BESTELNUMMER N° DE COMMANDE	∅	
SELPXV101	6 x 60 mm	100 / 900

Nylon slagplug kruis
Cheville Nylon à frapper



BESTELNUMMER N° DE COMMANDE	∅	
SELCXP102	5 X 30 mm	100/ 2000
SELCXP104	5 X 40 mm	100/ 2000
SELCXP106	6 x 40 mm	100 / 2000

SNELMONTAGE FIXATION RAPIDE

Plug met vijs
Cheville avec vis



BESTELNUMMER N° DE COMMANDE	∅	
215	6 mm	100

Verzinkte spreidplug voor gipsplaten
Cheville zinguée pour Gyproc



BESTELNUMMER N° DE COMMANDE	
9401001	200 / 4800

Messing pluggen
Chevilles laiton



BESTELNUMMER N° DE COMMANDE	Afm. Dim.	
BA43-06	M6x8x22mm	1
BA43-08	M8x10x28mm	1
BA43-10	M10x12x32mm	1
BA43-12	M12x15x38mm	1

Kleur pluggen
Chevilles de couleur



BESTELNUMMER N° DE COMMANDE	∅	KLEUR	COULEUR	
P1ES	5 mm	GEEL	JAUNE	100 / 2000
P2ES	5-5,5 mm	ROOD	ROUGE	100 / 2000
P3ES	7-8 mm	BRUIN	BRUN	100 / 2000

SNELMONTAGE FIXATION RAPIDE

Recht
Droit



BESTELNUMMER N° DE COMMANDE	Afm. Dim.	
250001	12 x 0,8 mm	10 / 900
250002	17 x 0,8 mm	10 / 600
250005	26 x 1,0 mm	10

Recht geplastificeerd
Droit plastifiée



BESTELNUMMER N° DE COMMANDE	Afm. Dim.	
251001	14 mm	10/ 720
251002	19 mm	10/ 480

Droit Plastifié - Rouleau en carton
Recht geplastificeerd - Rol in karton



BESTELNUMMER N° DE COMMANDE	Afm. Dim.	
251001C	14 mm	10/ 720
251002C	19 mm	10/ 480

Rond
Rond



BESTELNUMMER N° DE COMMANDE	Afm. Dim.	
350001	12 x 0,8 mm	10 / 900*
350002	17 x 0,8 mm	10 / 600*

* Op aanvraag / Sur demande

SNELMONTAGE FIXATION RAPIDE

Met Draad
Avec Filetage



BESTELNUMMER N° DE COMMANDE	Afm. Dim.	
501018	M6 x 8 x 18	200 / 3200
501025	M6 x 8 x 25	200 / 3200
501030	M6 x 8 x 30	200 / 3200
501040	M6 x 8 x 40	100 / 2400

Zonder draad
Sans filetage



BESTELNUMMER N° DE COMMANDE	∅	Afm. Dim.	
950418	Kraag/ Col 8 mm	4 x 18 mm	200 / 6400
960418	Kraag/ Col 10 mm	4 x 18 mm	200 / 6400

Drevel
Chasse goujons



BESTELNUMMER N° DE COMMANDE	Afm. Dim.	
10012	M6	1

Drevel met rubber handbeschermer
Chasse goujons avec protection caoutchouc



BESTELNUMMER N° DE COMMANDE	Afm. Dim.	
90HS4	4 mm	1
90HSM6	M6	1
90HSXXX	*	1

* Herstellingsset
* Set de réparation

SNELMONTAGE FIXATION RAPIDE

Tacker clips voor vloerverwarming
Tacker clips pour chauffage au sol



BESTELNUMMER N° DE COMMANDE	∅	Lengte Longueur	
TC57	12 - 20 mm	57 mm	1000/ 12000

per lader van 25 ST - Lengte 57mm
par chargeur de 25 PCS - Longueur 57mm

Nietapparaat voor Tacker-nieten
Pistolet pour Clips Tackers



BESTELNUMMER N° DE COMMANDE	∅	Lengte Longueur	
TCGUN	12 - 20 mm	57 mm	1

Lengte 57mm
Longeur 57mm

RAIL RAIL

Omega-profielen zonder perforatie Rails Omega sans perforation



BESTELNUMMER N° DE COMMANDE	Afm. Dim.	Lengte Longueur	
PD35Z	7,5 x 35 mm	2m	40 m
PD35CZ	15 x 35 mm	2m	20 m

Sendzimir verzinkt staal
Acier galvanisé Sendzimir

Omega-profielen met perforatie Rails Omega avec perforation



BESTELNUMMER N° DE COMMANDE	Afm. Dim.	Lengte Longueur	
PD35ZF6	7,5 x 35 mm	2m	40 m
PD35CZF6	15 x 35 mm	2m	20 m
PD15ZF4	15 X 55 mm	2m	100 m
PD32ZF6	15/6 X 32 mm*	2M	20 m

Sendzimir verzinkt staal
*Asymmetrische
Acier galvanisé Sendzimir
*Asymetrique

Snijmachine RAIL Machine à couper RAIL



BESTELNUMMER N° DE COMMANDE	Afm. Dim.	Lengte Longueur	
PDTR2M	875 x 130 mm	2m	1

Voor / Pour : PD35Z - PD35CZ - PD35ZF6 - PD35CZF6

Afbreekbare profielen Rails détachables



BESTELNUMMER N° DE COMMANDE	Specificiteit Spécificités	Afm. Dim.	
2761	*1	8 x 20 mm	100 m
761	*2	8 x 20 mm	50 m

Lengte / longueur : 2m
*1 Metal
*2 PVC

Ophangrail
Rail de suspension



BESTELNUMMER N° DE COMMANDE	Afm. Dim.	
9200900	15 x 30 mm	2/20 m

Sendzimir verzinkt staal/Acier galvanisé Sendzimir
Lengte/Longueur: 2m

DRAADSTANG TIGE FILETEE

Draadstang verzinkt
Tige filetée galvanisé



BESTELNUMMER N° DE COMMANDE	Afm. Dim.	
TR10006	M6x1000mm	1 / 100
TR10008	M8x1000mm	1 / 50
TR10010	M10x1000mm	1 / 25
TR10012	M12x1000mm	1 / 20
TR20006	M6x2000mm	1 / 50
TR20008	M8x2000mm	1 / 25
TR20010	M10x2000mm	1 / 25
TR20012	M12x2000mm	1 / 20
TR30006	M6x3000mm	1 / 50
TR30008	M8x3000mm	1 / 25
TR30010	M10x3000mm	1 / 25
TR30012	M12x3000mm	1 / 20

DIN 974 4.8
Inox op aanvraag
Inox sur demande

Afstandhouders
Entretoises



BESTELNUMMER N° DE COMMANDE	Afm. Dim.	
5720	M6-30 mm	1
5721	M6-50 mm	1
5722	M6-100 mm	1
5725	M8-30 mm	1
5726	M8-50 mm	1
5727	M8-100 mm	1

Galva

Slaganker met plug M8/M10
Cheville à frapper et cheville avec filetage interne M10/M8



BESTELNUMMER N° DE COMMANDE	
9401051	100



DRAADSTANG TIGE FILETEE

Schroefanker met Plug M10/M8

Vis à béton et cheville avec filetage interne M10/M8



BESTELNUMMER N° DE COMMANDE	
9401052	50



Stokvijs

Vis sans tête



BESTELNUMMER N° DE COMMANDE	Afm. Dim.	
HB0050	M8-50 mm	100
HB0060	M8-60 mm	100
HB0070	M8-70 mm	100
HB0080	M8-80 mm	100
HB0100	M8-100 mm	100
HB0120	M8-120 mm	100
HB0150	M8-150 mm	100
HB0180	M8-180 mm	100

Schroef met houtdraad en metrische draadeindje voor M8 beugels

Vis à filetage bois et filetage métrique pour supports M8

Inslaganker met kraag

Douilles de frappe avec colerette



BESTELNUMMER N° DE COMMANDE	Afm. Dim.	
2014	M8	100
2016	M10	100
2012	M10	100



FUNCTIE BEHOUD MAINTIENT DE FONCTION

Keilbout
Boulon expansible



BESTELNUMMER N° DE COMMANDE	Afm. Dim.	RAL	
4570	M8 x32		100



Brandwerend Schroefanker - MMS Plus
Vis à maintient de fonction - MMS Plus



BESTELNUMMER N° DE COMMANDE	Afm. Dim.	
9421	MMS-PLUS MS 7.5X40	50
9422	MMS-PLUS ST 6.0X55	50
9423	MMS-PLUS P 6.0X50	50
9424	MMS-PLUS P 6.0X35	50



KABELBINDERS COLLIERS DE CÂBLAGE

Zwart
Noir



BESTELNUMMER N° DE COMMANDE	Afm. Dim.	
SEL3201	75 x 2,5	100 / 5000
SEL3202	100 x 2,5	100 / 5000
SEL3203	135 x 2,5	100 / 5000
SEL3204	160 x 2,5	100 / 5000
SEL3205	200 x 2,5	100 / 5000
SEL3210	140 x 3,5	100 / 5000
SEL3211	200 x 3,5	100 / 5000
SEL3216	250 x 3,5	100 / 5000
SEL3212	280 x 3,5	100 / 5000
SEL3214	360 x 3,5	100 / 4000
SEL3220	140 x 4,5	100 / 5000
SEL3221	160 x 4,5	100 / 5000
SEL3222	180 x 4,5	100 / 5000
SEL3223	200 x 4,5	100 / 5000
SEL3224	250 x 4,5	100 / 5000
SEL3425	280 x 4,5	100 / 5000
SEL3429	300 x 4,5	100 / 4000
SEL3426	360 x 4,5	100 / 4000
SEL3427	380 x 4,5	100 / 3500
SEL3428	430 x 4,5	100 / 2500
SEL3430	180 x 7,5	100 / 2500
SEL3431	240 x 7,5	100 / 2000
SEL3432	200 x 7,5	100 / 5000
SEL3433	280 x 7,5	100 / 2000
SEL3438	320 x 7,5	100 / 1500
SEL3434	360 x 7,5	100 / 1500
SEL2435	450 x 7,5	100 / 2500
SEL3436	500 x 7,5	100 / 1000
SEL3441	750 x 7,5	100 / 700
SEL3144	430 x 9,0	100 / 1000
SEL3142	550 x 9,0	100 / 700
SEL3143	780 x 9,0	100 / 500
SEL3155	1220 x 9,0	100 / 500
SEL3150	250 x 12,5	50 / 500
SEL3447	360 x 6,0	100 / 1500
SEL3451	500 x 12,5	50 / 500
SEL3452	750 x 12,5	50 / 500
SEL3453	1000 x 12,5	50 / 500

Nylon PA 6.6



KABELBINDERS COLLIERS DE CÂBLAGE

Wit
Blanc



BESTELNUMMER N° DE COMMANDE	Afm. Dim.	
SEL2201	75 x 2,5	100 / 5000
SEL2202	100 x 2,5	100 / 5000
SEL2203	135 x 2,5	100 / 5000
SEL2204	160 x 2,5	100 / 5000
SEL2205	200 x 2,5	100 / 5000
SEL2210	140 x 3,5	100 / 5000
SEL2211	200 x 3,5	100 / 5000
SEL3215	225 x 3,5	100 / 5000
SEL2216	250 x 3,5	100 / 5000
SEL2212	280 x 3,5	100 / 5000
SEL2214	360 x 3,5	100 / 4000
SEL2220	140 x 4,5	100 / 5000
SEL2221	160 x 4,5	100 / 5000
SEL2222	180 x 4,5	100 / 5000
SEL2223	200 x 4,5	100 / 5000
SEL2224	250 x 4,5	100 / 5000
SEL2425	280 x 4,5	100 / 5000
SEL2429	300 x 4,5	100 / 4000
SEL2426	360 x 4,5	100 / 4000
SEL2427	380 x 4,5	100 / 3500
SEL2428	430 x 4,5	100 / 2500
SEL2430	180 x 7,5	100 / 2500
SEL2432	200 x 7,5	100 / 5000
SEL2431	240 x 7,5	100 / 2000
SEL2433	280 x 7,5	100 / 2000
SEL2438	320 x 7,5	100 / 1500
SEL2434	360 x 7,5	100 / 1500
SEL2435	450 x 7,5	100 / 2500
SEL2436	500 x 7,5	100 / 1000
SEL3437	540 x 7,5	100 / 2500
SEL2441	750 x 7,5	100 / 700
SEL2144	430 x 9,0	100 / 1000
SEL2142	550 x 9,0	100 / 700
SEL2143	780 x 9,0	100 / 500
SEL2155	1220 x 9,0	100 / 500
SEL2450	250 x 12,5	50 / 500
SEL2451	500 x 12,5	50 / 500
SEL2452	750 x 12,5	50 / 500
SEL2453	1000 x 12,5	50 / 500

Nylon PA 6.6



KABELBINDERS COLLIERS DE CÂBLAGE

Kabelbinders gekleurd

Colliers de câblage colorés



Rood / Rouge RAL 3000
 Blauw / Bleu RAL 5002
 Groen / Vert RAL 6024
 Geel / Jaune RAL 1201
 Nylon PA 6.6



BESTELNUMMER N° DE COMMANDE	Afm. Dim.	KLEUR	COULEUR	
SEL.10.202R	100 x 2,5	Rood	Rouge	100 / 5000
SEL.10.210R	140 x 3,5	Rood	Rouge	100 / 5000
SEL.10.223R	200 x 4,5	Rood	Rouge	100 / 5000
SEL.10.425R	280 x 4,5	Rood	Rouge	100 / 5000
SEL.11.202R	100 x 2,5	Blauw	Bleu	100 / 5000
SEL.11.210R	140 x 3,5	Blauw	Bleu	100 / 5000
SEL.11.223R	200 x 4,5	Blauw	Bleu	100 / 5000
SEL.11.425R	280 x 4,5	Blauw	Bleu	100 / 5000
SEL.12.202R	100 x 2,5	Groen	Vert	100 / 5000
SEL.12.210R	140 x 3,5	Groen	Vert	100 / 5000
SEL.12.223R	200 x 4,5	Groen	Vert	100 / 5000
SEL.12.425R	280 x 4,5	Groen	Vert	100 / 5000
SEL.14.202R	100 x 2,5	Geel	Jaune	100 / 5000
SEL.14.210R	140 x 3,5	Geel	Jaune	100 / 5000
SEL.14.223R	200 x 4,5	Geel	Jaune	100 / 5000
SEL.14.425R	280 x 4,5	Geel	Jaune	100 / 5000

Kabelstrip wit - met markeerplaat 8 x 25 mm

Collier blanc - avec plaquette d'identification 8 x 25 mm



BESTELNUMMER N° DE COMMANDE	Afm. Dim.	
SEL.2.202T	100 x 2,5	100 / 5000

Nylon PA 6.6



KABELBINDERS COLLIERS DE CÂBLAGE

Centuring Polyamide 12

Centuring Polyamide 12



BESTELNUMMER N° DE COMMANDE	Afm. Dim.	
SEL3320	180 x 9	100 / 3500
SEL3321	265 x 9	100 / 2000
SEL3322	360 x 9	100 / 1400
SEL3323	500 x 9	100 / 1000
SEL3324	750 x 9	100 / 1000



Spantang voor Centuring

Pince à sertir pour Centuring



BESTELNUMMER N° DE COMMANDE	∅	
PIN005	∅	1

Maximale breedte 9 mm

Largeur maximale 9 mm

Inox kabelbinders

Colliers de câblage en Inox



BESTELNUMMER N° DE COMMANDE	Afm. Dim.	
SSCT1	150x4.6	100
SSCT2	200x4.6	100
SSCT3	360x4.6	100
SSCT4	520x4.6	100
SSCT5	360x7.9	100
SSCT6	300x4.6	100
SSCT7	520x7.9	100

Plastic coating voor extra randbescherming.

Coating en plastic pour protection supplémentaire des côtés.

UV resistant, low smoke & HF.

KABELBINDERS COLLIERS DE CÂBLAGE

Spantangen

Pinces à sertir



BESTELNUMMER N° DE COMMANDE	Specificiteit Spécificités	
PIN003-CTTN	*1	1
PIN006-CTTS	*2	1

*1

Tang in metaal - Spantang tot 4,8 mm voor nylon - Snijdt zonder braam.

Pince en métal - Pince à serrage pour nylon jusqu'à 4,8 mm - Coupe sans morfil.

*2

Tang in metaal. Spantang tot 7,9 mm voor metalen kabelbinders - Snijdt zonder braam.

Pince en métal - Pince à serrage pour colliers en métal jusqu'à 7,9 mm - Coupe sans morfil.

Nylon binders met Inox tand - naturel

Colliers en nylon avec dent en acier Inox - naturel



BESTELNUMMER N° DE COMMANDE	Afm. Dim.	
MET22102R	100 x 2,5	100
MET22105R	200 x 2,5	100
MET22110R	140 x 3,5	100
MET22111R	200 x 3,5	100
MET22112R	280 x 3,5	100
MET22123R	200 x 4,5	100
MET22126R	360 x 4,5	100
MET22140R	290 x 4,5	100
MET22534R	360 x 7,5	100



Nylon binders met Inox tand - zwart

Colliers en nylon avec dent en acier Inox - noir



BESTELNUMMER N° DE COMMANDE	Afm. Dim.	
MET32102R	100 x 2,5	100
MET32105R	200 x 2,5	100
MET32110R	140 x 3,5	100
MET32111R	200 x 3,5	100
MET32112R	280 x 3,5	100
MET32123R	200 x 4,5	100
MET32126R	360 x 4,5	100
MET32326R	360 X 4,5	100
MET32140R	290 x 4,5	100



KABELBINDERS COLLIERS DE CÂBLAGE

Nylon binders met Inox tand - zwart
Colliers en nylon avec dent en acier Inox - noir



BESTELNUMMER N° DE COMMANDE	Afm. Dim.	
MET32534R	360 x 7,5	100



Click Tie - herbruikbaar - Rood
Click Tie - réouvrable et réutilisable - Rouge



BESTELNUMMER N° DE COMMANDE	Afm. Dim.	
CLT102110R	120 x 3,5	100 / 5000
CLT102116R	240 x 3,8	100 / 5000
CLT102129R	320 x 4,4	100 / 5000
CLT102149R	500 x 5,6	100 / 5000



Plug voor kabelbinders M8
Cheville pour colliers de serrage M8



BESTELNUMMER N° DE COMMANDE	
MF111	100 / 3500

Plug voor kabelbinders tot 9 mm breed.
Cheville pour collier de serrage jusqu'à 9 mm de largeur.



Zelfklevende 2-weg consoles
Consoles adhésives double direction



BESTELNUMMER N° DE COMMANDE	Afm. Dim.	
SEL2501	ø 20 mm	100 / 3000
SEL2502	ø 28 mm	100 / 3000



KABELBINDERS COLLIERS DE CÂBLAGE

Identificatieplaatje

Plaquette d'identification



BESTELNUMMER N° DE COMMANDE	Afm. Dim.	
SEL101	20x40x1,3mm	100 / 3000



Klipconsole 'Hooks' zelfklevend

Consoles clips 'Hooks' adhésifs



BESTELNUMMER N° DE COMMANDE	Afm. Dim.	
SEL2401	10 x 19	100 / 3000
SEL2402	13 x 26	100 / 3000
SEL2403	18 x 26	100 / 3000



KABELSCHOENEN SOULIERS DE CABLE

Niet geïsoleerde kabelschoenen

Souliers de câbles non isolés



Vertind / Etamé

Geleidbaarheid / Conductivité : 99,9 % IACS BS 6017 - BS 1977

REMARQUE : Quand un câble souple est utilisé, il est nécessaire de sélectionner la dimension suivante plus grande.

Dimension en mm² du câble : le nombre du n° de commande avant le / : p.e. D035/10.

OPMERKING : Wanneer soepele kabels gebruikt worden, is het noodzakelijk de volgende grotere maat van kabelschoen te selecteren.

Afmeting in mm² van de kabel : het getal van het bestelnummer voor de / : bv. D035/10.

BESTELNUMMER N° DE COMMANDE	∅
D006/04	4,1 mm
D006/05	5,2 mm
D006/06	6,5 mm
D006/08	8,4 mm
D010/05	5,2 mm
D010/06	6,5 mm
D010/08	8,4 mm
D010/10	10,5 mm
D016/05	5,2 mm
D016/06	6,5 mm
D016/08	8,4 mm
D016/10	10,5 mm
D025/05	5,2 mm
D025/06	6,5 mm
D025/08	8,4 mm
D025/10	10,5 mm
D035/06	6,5 mm
D035/08	8,4 mm
D035/10	10,5 mm
D035/12	13 mm
D050/06	6,5 mm
D050/08	8,4 mm
D050/10	10,5 mm
D050/12	13 mm
D070/08	8,4 mm
D070/10	10,5 mm
D070/12	13 mm
D070/14	15 mm
D095/08	8,4 mm
D095/10	10,5 mm
D095/12	13 mm
D095/14	15 mm
D120/10	10,5 mm
D120/12	13 mm
D120/14	15 mm
D150/08	8,4 mm
D150/10	10,5 mm
D150/12	13 mm
D150/14	15 mm
D185/10	10,5 mm
D185/12	13 mm
D185/14	15 mm
D240/10	10,5 mm
D240/12	13 mm

KABELSCHOENEN SOULIERS DE CABLE

Niet geïsoleerde kabelschoenen

Souliers de câbles non isolés



BESTELNUMMER N° DE COMMANDE	ø
D240/14	15 mm
D240/16	17 mm
D240/20	20 mm
D300/12	13 mm
D300/14	15 mm
D300/16	17 mm

Doorverbinders

Raccords



Afmeting in mm² van de kabel/Dimensions en mm² du câble :

- 2,5 mm² voor DB02
- het getal na DB.. in het bestelnummer/le nombre après DB

BESTELNUMMER N° DE COMMANDE	ø IN	Afm. Dim.
DB02	ø 2,4 mm	1,5 mm ²
DB04	ø 4 mm	2,5 mm ²
DB06	ø 3,8 mm	06 mm ²
DB10	ø 4,5 mm	10 mm ²
DB16	ø 5,4 mm	16 mm ²
DB25	ø 6,8 mm	25 mm ²
DB35	ø 8,2 mm	35 mm ²
DB50	ø 9,5 mm	50 mm ²
DB70	ø 11,2 mm	70 mm ²
DB95	ø 13,5 mm	95 mm ²
DB120	ø 15 mm	120 mm ²
DB150	ø 16,5 mm	150 mm ²
DB185	ø 18,5 mm	185 mm ²
DB240	ø 21 mm	240 mm ²

KABELSCHOENEN SOULIERS DE CABLE

Geïsoleerde kabelschoenen 0,5 à 1,5 mm²

Souliers de câbles isolés 0,5 à 1,5 mm²

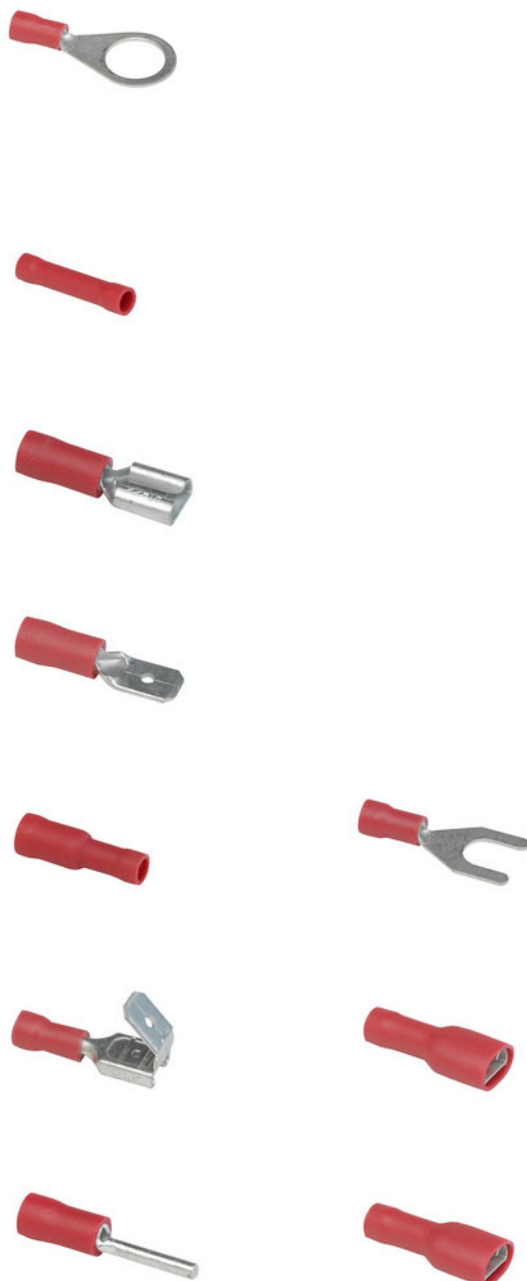

De geïsoleerde kabelschoenen zijn in koper en messing met hoge conductiviteit, vertind voor een verhoogde weerstand tegen corrosie.

Les cosses préisolées sont en cuivre et laiton de haute conductivité, étamés pour résistance à la corrosion.

Verpakking / emballage : 100 / 1000

BESTELNUMMER N° DE COMMANDE	Omschrijving	Description	ø
DVR1/03	Ring	Ring	3,2
DVR1/03.7	Ring	Ring	3,7
DVR1/04	Ring	Ring	4,3
DVR1/05	Ring	Ring	5,3
DVR1/06	Ring	Ring	6,4
DVR1/08	Ring	Ring	8,4
DVR1/10	Ring	Ring	10,5
DVR1/12	Ring	Ring	13
DVF1/03	Vork	Fourchette	3,2
DVF1/03.7	Vork	Fourchette	3,7
DVF1/04	Vork	Fourchette	4,3
DVF1/05	Vork	Fourchette	5,3
DVF1/06	Vork	Fourchette	6,4
DVPO1/4.8M	Doorverb. Mannelijk	Raccord mâle	-
DVPO1/6.3M	Doorverb. Mannelijk	Raccord mâle	-
DVPO1/2.8F	Doorverb. vrouwelijk	Raccord fémelle	
DVPO1/4.8F	Doorverb. vrouwelijk	Raccord fémelle	
DVPO1/6.3F	Doorverb. vrouwelijk	Raccord fémelle	
DVFP01/4.8F	Vrouwelijk geheel geïsoleerd	Fémelle complètement isolé	
DVFP01/6.3F	Vrouwelijk geheel geïsoleerd	Fémelle complètement isolé	
DVFP01/2.8F	Vrouwelijk geheel geïsoleerd	Fémelle complètement isolé	
DVPOA1/6.3	Mannelijk + vrouwelijk	Mâle + fémelle	
DVAB1M	Rond mannelijk	Mâle rond	
DVAB1F	Rond vrouwelijk	Fémelle rond	
DVBC1	Doorverb.	Raccord	
DVP1/09	Pin	Embout	9
DVP1/12	Pin	Embout	12

KABELSCHOENEN SOULIERS DE CABLE

Geïsoleerde kabelschoenen 1,5 à 2,5 mm²

Souliers de câbles isolés 1,5 à 2,5 mm²



De geïsoleerde kabelschoenen zijn in koper en messing met hoge conductiviteit, vertind voor een verhoogde weerstand tegen corrosie.

Les cosses préisolées sont en cuivre et laiton de haute conductivité, étamés pour résistance à la corrosion.

Emb./Verp. : 100/1000

BESTELNUMMER N° DE COMMANDE	Omschrijving	Description	ø
DVR2/03	Ring	Plage oeil	3,2 mm
DVR2/03.7	Ring	Plage oeil	3,7 mm
DVR2/04	Ring	Plage oeil	4,3 mm
DVR2/05	Ring	Plage oeil	5,3 mm
DVR2/06	Ring	Plage oeil	6,4 mm
DVR2/08	Ring	Plage oeil	8,4 mm
DVR2/10	Ring	Plage oeil	10,5 mm
DVR2/12	Ring	Plage oeil	13 mm
DVF2/03	Vork	Fourchette	3,2 mm
DVF2/03.7	Vork	Fourchette	3,7 mm
DVF2/04	Vork	Fourchette	4,3 mm
DVF2/05	Vork	Fourchette	5,3 mm
DVF2/06	Vork	Fourchette	6,4 mm
DVPO2/4.8M	Doorverb. mannelijk	Raccord mâle	
DVPO2/6.3M	Doorverb. mannelijk	Raccord mâle	
DVPO2/2.8F	Doorverb. vrouwelijk	Raccord femelle	
DVPO2/4.8F	Doorverb. vrouwelijk	Raccord femelle	
DVPO2/6.3F	Doorverb. vrouwelijk	Raccord femelle	
DVFP02/4.8F	Vrouwelijk geheel geïsoleerd	Fémelle compl. isolé	
DVFP02/6.3F	Vrouwelijk geheel geïsoleerd	Fémelle compl. isolé	
DVPOA2/6.3	Mannelijk + vrouwelijk	Mâle + femelle	
DVAB2M	Rond mannelijk	Mâle rond	
DVAB2F	Rond vrouwelijk	Fémelle rond	
DVBC2	Doorverb.	Raccord	
DVP2/09	Pin	Embout	9
DVP2/12	Pin	Embout	12

KABELSCHOENEN SOULIERS DE CABLE

Geïsoleerde kabelschoenen 4 à 6 mm²

Souliers de câbles isolés 4 à 6 mm²



BESTELNUMMER N° DE COMMANDE	Omschrijving	Description	ø
DVR5/03	Ring	Plage oeil	3,2 mm
DVR5/03.7	Ring	Plage oeil	3,7 mm
DVR5/04	Ring	Plage oeil	4,3 mm
DVR5/05	Ring	Plage oeil	5,3 mm
DVR5/06	Ring	Plage oeil	6,4 mm
DVR5/08	Ring	Plage oeil	8,4 mm
DVR5/10	Ring	Plage oeil	10,5 mm
DVR5/12	Ring	Plage oeil	13 mm
DVR5/14	Ring	Plage oeil	15 mm
DVR5/16	Ring	Plage oeil	17 mm
DVF5/ 03	Vork	Fourchette	3,7 mm
DVF5/ 04	Vork	Fourchette	4,3 mm
DVF5/05	Vork	Fourchette	5,3 mm
DVF5/06	Vork	Fourchette	6,4 mm
DVF5/08	Vork	Fourchette	8 mm
DVP O 5 /6 .3 M	Doorverb. mannelijk	Raccord mâle	
DVP O 5 /6 .3 F	Doorverb. vrouwelijk	Raccord fémelle	
DVP O 5 /9 .5 F	Doorverb. vrouwelijk	Raccord fémelle	
DVFP O5 /6.3F	Vrouwelijk geheel geïsoleerd	Fémelle complètem isolé	
DVFP O5 /9.5F	Vrouwelijk geheel geïsoleerd	Fémelle complètem isolé	
DVBC 5	Doorverb.	Raccord	
DVP 5/ 1 4	Pin	Embout	14

De geïsoleerde kabelschoenen zijn in koper en messing met hoge conductiviteit, vertind voor een verhoogde weerstand tegen corrosie.

Les cosses préisolées sont en cuivre et laiton de haute conductivité, étamés pour résistance à la corrosion.

Emb./ Verp. : 100/1000

PVC KANALEN CANAUX PVC

Type G - Grijs

Type G - Gris



BESTELNUMMER N° DE COMMANDE	Afm. Dim.	
G16	25x30 mm	80 m
G23	40x30 mm	48 m
G24	60x30 mm	32 m
G13	25x40 mm	60 m
G8	40x40 mm	40 m
G4	60x40 mm	24 m
G26	80x40 mm	24 m
G27	100x40 mm	16 m
G28	120x40 mm	20 m
G7	25x60 mm	40 m
G5	40x60 mm	36 m
G9	60x60 mm	24 m
G6	80x60 mm	24 m
G17	100x60 mm	20 m
G10	120x60 mm	16 m
G30	150x60 mm	12 m
G31	200x60 mm	8 m
G50	250x70 mm	8 m
G14	25x80 mm	32 m
G15	40x80 mm	24 m
G11	60x80 mm	24 m
G12	80x80 mm	24 m
G19	100x80 mm	16 m
G32	120x80 mm	16 m
G33	150x80 mm	12 m
G48	200x80 mm	8 m
G35	40x100 mm	16 m
G18	60x100 mm	16 m
G37	100x100 mm	16 m
G38	120x100 mm	8 m
G39	150x100 mm	8 m
G40	200x100 mm	8 m
G43	100x150 mm	8 m

Lengte : 2 meter

Kleur : Grijs RAL 7030

Deksel inbegrepen

Longueur : 2 mètres

Couleur : Gris RAL 7030

Couvercle inclus

LIJST VAN DE TOEBEHOREN - ZIE WWW.GSV.BE

LISTE DES ACCESSOIRES - SUR WWW.GSV.BE

PVC KANALEN CANAUX PVC

Type G - Wit

Type G - Blanc



BESTELNUMMER N° DE COMMANDE	Afm. Dim.	
G16BEU	25x30 mm	80 m
G23BEU	40x30 mm	48 m
G8BEU	40x40 mm	40 m
G4BEU	60x40 mm	24 m
G27BEU	100x40 mm	16 m
G9BEU	60x60 mm	24 m
G6BEU	80x60 mm	24 m
G17BEU	100x60 mm	20 m
G10BEU	120x60 mm	16 m
G30BEU	150x60 mm	12 m
G31BEU	200x60 mm	8 m
G50BEU	250x70 mm	8 m
G19BEU	100x80 mm	16 m
G33BEU	150x80 mm	12 m
G48BEU	200x80 mm	8 m
G40BEU	200x100 mm	8 m

Lengte : 2 meter Kleur : Wit RAL 9010

Deksel inbegrepen

Longueur : 2 mètres

Couleur : Blanc RAL 9010

Couvercle inclus

LIJST VAN DE TOEBEHOREN - ZIE WWW.GSV.BE

LISTE DES ACCESSOIRES - SUR WWW.GSV.BE

Type G - 1,3 m - Wit

Type G - 1,3 m - Blanc



BESTELNUMMER N° DE COMMANDE	Afm. Dim.	
G31EKBEU	200x60 mm	5,2 m
G50EKBEU	250x70 mm	5,2 m
G40EKBEU	200x100 mm	5,2 m

Lengte : 1,3 meter

Kleur : Wit RAL 9010

Compleet met deksel

Longueur : 1,3 mètres

Couleur : Blanc RAL 9010

Complet avec couvercle

LIJST VAN DE TOEBEHOREN - ZIE WWW.GSV.BE

LISTE DES ACCESSOIRES - SUR WWW.GSV.BE

PVC KANALEN CANAUX PVC

Type G - 1,5 m - Wit

Type G - 1,5 m - Blanc



BESTELNUMMER N° DE COMMANDE	Afm. Dim.	
G31KBEU	200x60 mm	6 m
G50KBEU	250x70 mm	6 m

Lengte : 1,5 meter

Kleur : Wit RAL 9010

Compleet met deksel

Longueur : 1,5 mètres

Couleur : Blanc RAL 9010

Complet avec couvercle

LIJST VAN DE TOEBEHOREN - ZIE WWW.GSV.BE

LISTE DES ACCESSOIRES - SUR WWW.GSV.BE

Type E - 12-8 mm

Type E - 12-8 mm

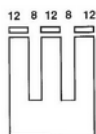

BESTELNUMMER N° DE COMMANDE	Afm. Dim.	
E20	15 x 17 mm	120 m
E22	15 x 30 mm	80 m
E16	25 x 30 mm	80 m
E23	40 x 30 mm	48 m
E24	60 x 30 mm	32 m
E25	15 x 40 mm	72 m
E13	25 x 40 mm	60 m
E8	40 x 40 mm	40 m
E4	60 x 40 mm	24 m
E26	80 x 40 mm	24 m
E27	100 x 40 mm	16 m
E28	120 x 40 mm	16 m
E7	25 x 60 mm	40 m
E5	40 x 60 mm	36 m
E9	60 x 60 mm	24 m
E6	80 x 60 mm	24 m
E17	100 x 60 mm	20 m
E10	120 x 60 mm	16 m
E30	150 x 60 mm	12 m
E31	200 x 60 mm	8 m
E14	25 x 80 mm	32 m
E15	40 x 80 mm	24 m
E11	60 x 80 mm	24 m
E12	80 x 80 mm	24 m
E19	100 x 80 mm	16 m

Lengte : 2 meter

Kleur : Grijs RAL 7030

Deksel inbegrepen

Longueur : 2 mètres

Couleur : Gris RAL 7030

Couvercle inclus

PVC KANALEN CANAUX PVC

Type E - 12-8 mm

Type E - 12-8 mm

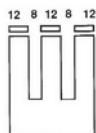



BESTELNUMMER N° DE COMMANDE	Afm. Dim.	
E32	120 x 80 mm	16 m
E33	150 x 80 mm	12 m
E48	200 x 80 mm	8 m
E34	25 x 100 mm	24 m
E35	40 x 100 mm	16 m
E18	60 x 100 mm	16 m
E36	80 x 100 mm	16 m
E37	100 x 100 mm	16 m
E38	120 x 100 mm	8 m
E39	150 x 100 mm	8 m
E40	200 x 100 mm	8 m
E43	100 x 150 mm	8 m

Lengte : 2 meter
 Kleur : Grijs RAL 7030
 Deksel inbegrepen
 Longueur : 2 mètres
 Couleur : Gris RAL 7030
 Couvercle inclus

Type E - DIN - 7,5-5 mm

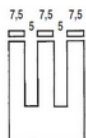
Type E - DIN - 7,5-5 mm



BESTELNUMMER N° DE COMMANDE	Afm. Dim.	
ED2525	25 x 25 mm	84 m
ED2537	25 x 37,5 mm	64 m
ED3737	37,5 x 37,5 mm	48 m
ED2550	25 x 50 mm	52 m
ED3750	37,5 x 50 mm	32 m
ED5050	50 x 50 mm	24 m
ED7550	75 x 50 mm	24 m
ED10050	100 x 50 mm	16 m
ED2575	25 x 75 mm	32 m
ED3775	37,5 x 75 mm	32 m
ED5075	50 x 75 mm	24 m
ED7575	75 x 75 mm	16 m
ED10075	100 x 75 mm	16 m
ED12575	125 x 75 mm	12 m

Lengte/Longueur : 2 m
 Kleur/Couleur : Grijs/Gris RAL 7030
 Deksel inbegrepen/ Couvercle Inclus
 OP AANVRAAG / SUR DEMANDE
 Verkrijgbaar in halogeenvrije uitvoering.
 Disponible en version sans halogène.

PVC KANALEN CANAUX PVC

Type E - 6-4 mm

Type E - 6-4 mm

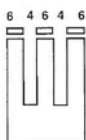

BESTELNUMMER N° DE COMMANDE	Afm. Dim.	
E164	25 x 30 mm	80 m
E134	25 x 40 mm	60 m
E84	40 x 40 mm	40 m
E44	60 x 40 mm	24 m
E264	80 x 40 mm	24 m
E74	25 x 60 mm	40 m
E54	40 x 60 mm	36 m
E94	60 X 60 mm	24 m
E64	80 x 60 mm	24 m
E174	100 x 60 mm	20 m
E104	120 x 60 mm	16 m
E144	25 x 80 mm	32 m
E154	40 x 80 mm	24 m
E114	60 x 80 mm	24 m
E124	80 x 80 mm	24 m
E194	100 x 80 mm	16 m
E324	120 x 80 mm	16 m
E344	25 x 100 mm	24 m
E354	40 x 100 mm	16 m
E184	60 x 100 mm	16 m
E364	80 x 100 mm	16 m
E374	100 x 100 mm	16 m

Lengte : 2 meter
 Kleur : Grijs RAL 7030
 Deksel inbegrepen
 Longueur : 2 mètres
 Couleur : Gris RAL 7030
 Couvercle inclus

Dwarsclips voor type E

Traverses pour type E



BESTELNUMMER N° DE COMMANDE	Afm. Dim.	
PTR	100 mm	25 / 100
TR06	60 mm	1
TR08	80 mm	1
TR10	100 /120 mm	1

PVC KANALEN CANAUX PVC

Klinknagels en Drevel voor dito
Rivets et Chasse pour dito



BESTELNUMMER N° DE COMMANDE	Specificiteit Spécificités	Afm. Dim.	
RIV1	Zwart/ Noir	ø 6,5-7 mm	200
RIV2	Groen/ Vert	ø 4,5-5,5 mm	200
PRRIV1	Tool	RIV1	1
PRRIV2	Tool	RIV2	1

Type E - 6-6,5 mm - LSOH
Type E - 6-6,5 mm - LSOH

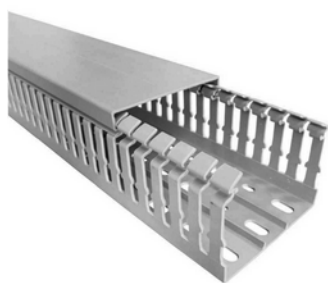

BESTELNUMMER N° DE COMMANDE	Afm. Dim.	
V6H2525	25 x 25 mm	50
V6H4025	25 x 40 mm	48
V6H4040	40 x 40 mm	50
V6H4060	60 x 40 mm	50
V6H4080	80 x 40 mm	30
V6H6025	25 x 60 mm	60
V6H6040	40 x 60 mm	40
V6H6060	60 x 60 mm	24
V6H6080	80 x 60 mm	20
V6H60100	100 x 60 mm	16
V6H60120	120 X 60 mm	12
V6H8025	25 x 80 mm	20
V6H8040	40 x 80 mm	20
V6H8060	60 x 80 mm	20
V6H8080	80 x 80 mm	12
V6H80100	100 x 80 mm	12
V6H80120	120 x 80 mm	16
V6H10060	60 x 100 mm	16
V6H10080	80 x 100 mm	16
V6H100100	100 x 100 mm	12

Lengte : 2 meter Kleur :
Grijs RAL 7035
Deksel inbegrepen
Longueur : 2 mètres
Couleur : Gris RAL 7035
Couvercle inclus



PVC KANALEN CANAUX PVC

Kniptang voor bedradingskanalen type E
Pince pour goulottes type E



BESTELNUMMER N° DE COMMANDE	
ECUT	1

Snijmachine voor type E
Machine à couper pour goulottes type E



BESTELNUMMER N° DE COMMANDE	
WAB05200	1

Maximale afmeting : 120 x 120 mm
Zowel voor PVC als HF
Dimension maximale : 120 x 120 mm
Pour PVC comme pour HF

Deksels voor type E en G - Grijs
Couvercles pour type E et G - Gris

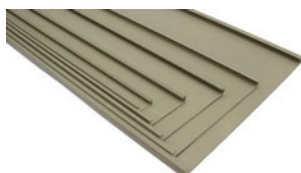

BESTELNUMMER N° DE COMMANDE	Afm. Dim.	Lengte Longueur
GCOP025	25 mm	2 m
GCOP040	40 mm	2 m
GCOP060	60 mm	2 m
GCOP080	80 mm	2 m
GCOP100	100 mm	2 m
GCOP120	120 mm	2 m
GCOP150	150 mm	2 m
GCOP200	200 mm	2 m

RAL 7030

PVC KANALEN CANAUX PVC

Deksels voor type G - Wit
Couvercles pour type G - Blanc



BESTELNUMMER N° DE COMMANDE	Afm. Dim.	Lengte Longueur
GCOP100BEU	100 mm	2 m
GCOP120BEU	120 mm	2 m
GCOP150BEU	150 mm	2 m
GCOP200BEU	200 mm	2 m

RAL 9010

Scheidingschotten voor type E en G
Séparations pour type E et G



BESTELNUMMER N° DE COMMANDE	Afm. Dim.	Lengte Longueur	
S1	40 mm	2 m	60 m
S2	60 mm	2 m	50 m

RAL 7030

Kabelhouders voor type E en G
Clips de câble pour type E et G



BESTELNUMMER N° DE COMMANDE	Afm. Dim.	
FCV12040	40/120x40 mm	100
FCV12060	40/200x60 mm	100

PVC KANALEN CANAUX PVC

Kanalen voor Airco - Wit

Canaux pour Air Conditionné - Blanc



BESTELNUMMER N° DE COMMANDE	Afm. Dim.	
CON30	35 x 30 mm	64 m
CON70	70 x 55 mm	24 m
CON90	90 x 65 mm	16 m
CON125	125 x 75 mm	8 m

UV bestendig Class1
 Résistance UV Class1
 Deksel inbegrepen
 Lengte : 2 meter
 Kleur : Wit RAL 9010
 Couvercle inclus
 Longueur : 2 mètres
 Couleur : Blanc RAL 9010
 LIJST VAN DE TOEBEHOREN - ZIE WWW.GSV.BE
 LISTE DES ACCESSOIRES - SUR WWW.GSV.BE

Kanalen voor Airco - Bruin

Canaux pour Air Conditionné - Marron





BESTELNUMMER N° DE COMMANDE	Afm. Dim.	
CON30M	35 x 30 mm	64 m
CON70M	70 x 55 mm	24 m
CON90M	90 x 65 mm	16 m
CON125M	125 x 75 mm	8 m

UV bestendig Class1
 Résistance UV Class1
 Deksel inbegrepen
 Lengte : 2 meter
 Couvercle inclus
 Longueur : 2 mètres
 Kleur : Bruin RAL 8017
 Couleur : Marron RAL 8017
 LIJST VAN DE TOEBEHOREN - ZIE WWW.GSV.BE
 LISTE DES ACCESSOIRES - SUR WWW.GSV.BE

Vloerkanalen

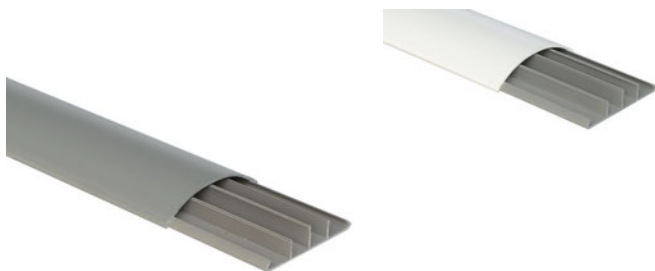
Canaux de sol



BESTELNUMMER N° DE COMMANDE	Afm. Dim.	
ZBFG	75 x 16 mm	40 m
ZBFG-M	50 x 12 mm	60 m
ZBFB	75 x 16 mm	40 m

Lengte / Longueur : 2 m
 ZBFG : Kleur/Couleur = grijs/gris
 ZBFB : Kleur/Couleur = wit/blanc

MINIKANALEN MINI GOULOTTE

Zelfklevende mini kanalen
Canaux mini autoadhésifs



BESTELNUMMER N° DE COMMANDE	Afm. Dim.	
J1207PAD	12 x 7 mm	160 m
J1610PAD	16 x 10 mm	90 m

Met clic-deksel inbegrepen
Lengte : 2 meter
Avec couvercle clic
Longueur : 2 mètres
Wit / Blanc

Minikanalen type BS
Canaux mini type BS



BESTELNUMMER N° DE COMMANDE	Afm. Dim.	
BS11BEU	16 x 16 mm	92 m
BS21BEU	25 x 16 mm	72 m
BS61BEU	60 x 16 mm	36 m

Deksel inbegrepen
Lengte : 2 meter
Couvercle inclus
Longueur : 2 mètres

Minikanalen type M
Canaux mini type M



BESTELNUMMER N° DE COMMANDE	Afm. Dim.	
M40017	40 x 17 mm	48 m

Deksel inbegrepen
Lengte : 2 meter
Couvercle inclus
Longueur : 2 mètres

MINIKANALEN MINI GOULOTTE

Toebehoren TYPE M

Accessoires TYPE M



BESTELNUMMER N° DE COMMANDE	Omschrijv	Description	Afm. Dim.	
M40039	Verstelb binnen	Angle extérieur ajustable	40 x 17 mm	1
M40040	Verstelb buiten	Angle extérieur ajustable	40 x 17 mm	1
M40041	T-stuk	Déviatio	40 x 17 mm	1
M40042	Vlakke hoek	Angle plat	40 x 17 mm	1
M40043	Koppelir	Raccord	40 x 17 mm	1
M40044	Eindstuk	Embout	40 x 17 mm	1

Universele opbouwdozen - TYPE M

Boîtiers universels - TYPE M

BESTELNUMMER N° DE COMMANDE	Omschrijv	Description	Afm. Dim.	
M400047001	Enkel	Simple	Modul 45x45	1
M400047002	Dubbel	Double	Modul 45x45	1
M400047003	Drievoudig	Triple	Modul 45x45	1

MINIKANALEN MINI GOULOTTE

TYPE G

TYPE G



BESTELNUMMER N° DE COMMANDE	Afm. Dim.	RAL	
G20BEU	15 x 18 mm	RAL 9010	120 m
G41BEU	20 x 10 mm	RAL 9010	120 m
G44BEU	25 x 20 mm	RAL 9010	60 m
G45BEU	40 x 20 mm	RAL 9010	42 m

Deksel inbegrepen
Lengte : 2 meter
Couvercle inclus
Longueur : 2 mètres
Wit - Blanc

MINIKANALEN MINI GOULOTTE

Toebehoren voor mini TYPE G

Accessoires pour MINI TYPE G



BESTELNUMMER N° DE COMMANDE	Omschrijving	Description	Afm. Dim.	
41E	Buitenhoek	Angle Exterieur	20 x 10 mm	10
44E	Buitenhoek	Buitenhoek	25 x 20 mm	5
GT248EB	Buitenhoek	Buitenhoek	40 x 20 mm	5
41I	Binnenhoek	Angle intérieur	20 x 10 mm	10
44I	Binnenhoek	Angle intérieur	25 x 20 mm	5
GT248IB	Binnenhoek	Angle intérieur	40 x 20 mm	5
41L	Vlakke Hoek	Angle Exterieur	20 x 10 mm	10
44L	Vlakke Hoek	Angle Exterieur	25 x 20 mm	5
GT248LB	Vlakke Hoek	Angle Exterieur	40 x 20 mm	5
41T	T Stuk	Dérivation T	20 x 10 mm	10
44LT	T Stuk	Dérivation T	25 x 20 mm	5
GT248TB	T Stuk	Dérivation T	40 x 20 mm	5
41G	Koppelstuk	Raccord	20 x 10 mm	10
44LG	Koppelstuk	Raccord	25 x 20 mm	5
GT248GB	Koppelstuk	Raccord	40 x 20 mm	5
41S	Eindstuk	Embout	20 x 10 mm	10
GT16A	Eindstuk	Embout	25 x 20 mm	5
GT248AB	Eindstuk	Embout	40 x 20 mm	5

Set : 20BLI = Blisterverpakking met toebehoren voor de G20B met : 1 Buitenhoek + 1 Binnenhoek + 2 Vlakke hoeken + 1 T-stuk + 1 Koppeling + 1 Eindstuk

MINIKANALEN MINI GOULOTTE

Kit Toebehoren voor mini TYPE G20B

Kit Accessoires pour MINI TYPE G20B

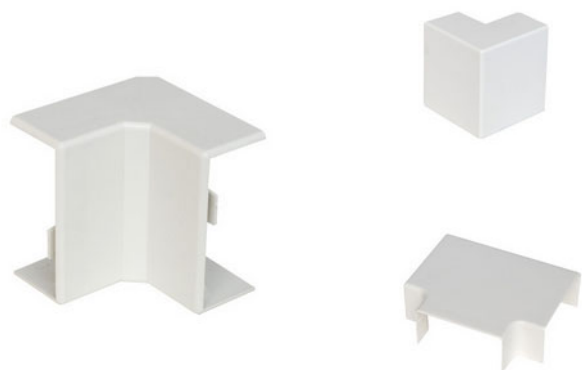

BESTELNUMMER N° DE COMMANDE	Omschrijving	Description	Afm. Dim.	
20BLI	Set voor G20B*	Set pour G20B*	15 x 18 mm	1

Set : 20BLI = Blisterverpakking met toebehoren voor de G20B met : 1 Buitenhoek + 1 Binnenhoek + 2 Vlakke hoeken + 1 T-stuk + 1 Koppeling + 1 Eindstuk

Set : 20BLI = Emballage blister avec les accessoires pour la G20B incluant : 1 Angle extérieur + 1 Angle intérieur + 2 Angles plat + 1 Déviation-T + 1 Raccord + 1 Pièce terminale

GOULOTTES MINI LSOH MINI KANALEN LSOH

TYPE INWAY

TYPE INWAY

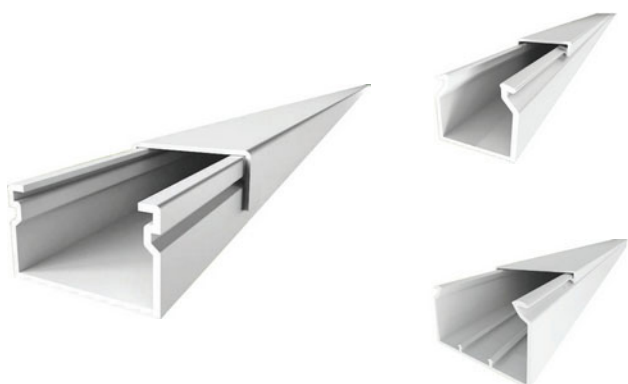

BESTELNUMMER N° DE COMMANDE	Afm. Dim.	RAL	
IW20125LH	20 x 12,5 mm	RAL 9010	80m
IW2020LH	20 x 20 mm	RAL 9010	50m
IW6040LH	60 x 40 mm	RAL 9010	32m

Deksel inbegrepen
Lengte : 2 meter
Couvercle inclus
Longueur : 2 mètres



LHD

LHD



BESTELNUMMER N° DE COMMANDE	Afm. Dim.	RAL	
LHD2010HF	20 x 10 mm	RAL 9003	96 m
LHD2020HF	20 x 20 mm	RAL 9003	48 m
LHD4020HF	40 x 20 mm	RAL 9003	24 m
LHD4040HF	40 x 40 mm	RAL 9003	20 m

Deksel inbegrepen
Lengte : 2 meter
Couvercle inclus
Longueur : 2 mètres
LIJST VAN DE TOEBEHOREN - ZIE WWW.GSV.BE
LISTE DES ACCESSOIRES - SUR WWW.GSV.BE



WANDKANALEN MUTLUSAN GOULOTTE MUTLUSAN

Wandkanalen Goulottes



BESTELNUMMER N° DE COMMANDE	Afm. Dim.	RAL	
M10037	100 x 37 mm	RAL 9016	30 m
M10050	100 x 50 mm	RAL 9016	20 m

Deksel inbegrepen
Lengte : 2 meter
Couvercle inclus
Longueur : 2 mètres

Verstelbare binnenhoek Angle intérieur flexible



BESTELNUMMER N° DE COMMANDE	Afm. Dim.	
M039	100 x 37/50	12



Verstelbare buitenhoek Angle extérieur flexible



BESTELNUMMER N° DE COMMANDE	Afm. Dim.	
M040	100 x 37/50	10



T-hoek Angle-T



BESTELNUMMER N° DE COMMANDE	Afm. Dim.	
M041	100 x 50	8
M041037	100 x 37	8



WANDKANALEN MUTLUSAN GOULOTTE MUTLUSAN

Koppelstuk
Joint



BESTELNUMMER N° DE COMMANDE	Afm. Dim.	
M043	100 x 37	100



Kabelhouder
Fixation pour cable



BESTELNUMMER N° DE COMMANDE	Afm. Dim.	
M050	100 x 37	100



Montageplaat
Plaque de montage



BESTELNUMMER N° DE COMMANDE	Specificiteit Spécificités	MOD.	
M047001	*1	1	20
M047002	*1	2	14
M047003	*1	3	12
M047004	*1	4	10
M0478001	*2	1	20

*1

Dekselset 45/45

Set pour module 45/45

*2

Montageplaat 80/80

Plaque de montage 80/80



WANDKANALEN MUTLUSAN GOULOTTE MUTLUSAN

Scheidingschot 2 meter voor M10050

Séparateur 2 mètres pour M10050



BESTELNUMMER N° DE COMMANDE	Afm. Dim.	
M013	48 mm	150 m



WANDKANALEN SYS45 RAPID GOULOTTES SYS45 RAPID

Wandkanalen SYS45 RAPID
Goulottes SYS45 RAPID



BESTELNUMMER N° DE COMMANDE	Afm. Dim.	RAL	
SYS751	75 x 50 mm	RAL 9010	24 m
SYS1252	125 x 50 mm	RAL 9010	16 m
SYS1603	160 x 50 mm	RAL 9010	12 m
SYS1051	100 x 50 mm	RAL 9010	16 m

Deksel inbegrepen
Lengte : 2 meter
Couvercle inclus
Longueur : 2 mètres
LIJST VAN DE TOEBEHOREN - ZIE WWW.GSV.BE
LISTE DES ACCESSOIRES - SUR WWW.GSV.BE

Deksels voor wandkanalen SYS45 RAPID
Couvercles pour goulottes SYS45 RAPID



BESTELNUMMER N° DE COMMANDE	Afm. Dim.	RAL	
SCO45	45 mm	RAL 9010	64 m

Lengte / Longueur : 2 mètres

Verbindingsstuk basis
Joint de fond



BESTELNUMMER N° DE COMMANDE	
SGACBEU	50

WANDKANALEN SYS45 RAPID GOULOTTES SYS45 RAPID

Dekselverbinder
Joint de couvercle



BESTELNUMMER N° DE COMMANDE	
SGCOBEU	20

Buitenhoek
Angle extérieur



BESTELNUMMER N° DE COMMANDE	Omschrijving Description	Afm. Dim.	
41E	Buitenhoek Angle Exterieur	20 x 10 mm	10
44E	Buitenhoek Buitenhoek	25 x 20 mm	5
GT248EB	Buitenhoek Buitenhoek	40 x 20 mm	5
LHD8926HF		20 x 10 mm	
LHD8626HF		20 x 20 mm	
LHD8636HF		40 x 20 mm	
LHD8646HF		40 x 40 mm	
LD075EBEU		75 mm	16
LD105EBEU		100 mm	15
LD125EBEU		125 mm	10
SAE160BEU		160 mm	4

Binnenhoek
Angle intérieur



BESTELNUMMER N° DE COMMANDE	Afm. Dim.	
LHD8925HF	20 x 10 mm	
LHD8625HF	20 x 20 mm	
LHD8635HF	40 x 20 mm	
LHD8645HF	40 x 40 mm	
LD075IBEU	75 mm	16
LD125IBEU	125 mm	10
SAI160BEU	160 mm	10

WANDKANALEN SYS45 RAPID GOULOTTES SYS45 RAPID

Vlakke hoek
Angle plat



BESTELNUMMER N° DE COMMANDE	Afm. Dim.	
LHD8923HF	20 x 10 mm	
LHD8623HF	20 x 20 mm	
LHD8633HF	40 x 20 mm	
LHD8643HF	40 x 40 mm	
M042	100 x 50	8
M042037	100 x 37	8
M040HF	100 x 37/50	10
LD075LBEU	75 mm	20
LD105LBEU	100 mm	10
LD125LBEU	125 mm	8
SAP160BEU	160 mm	10

T-stuk
Déviation-T



BESTELNUMMER N° DE COMMANDE	Afm. Dim.	
LHD8924HF	20 x 10 mm	
LHD8624HF	20 x 20 mm	
LHD8634HF	40 x 20 mm	
LHD8644HF	40 x 40 mm	
LD075TBEU	75 mm	12
LD105TBEU	100 mm	15
LD125TBEU	125 mm	10

Eindstuk
Embout



BESTELNUMMER N° DE COMMANDE	∅	Afm. Dim.	
Z10/16/3F	10 & 16 mm ²		10/250
Z16/2F	16 mm ²		10/250
Z16/4F	16 mm ²		10/250
LD075ABEU		75 mm	20
STT125BEU		125 mm	10
STT160BEU		160 mm	10

WANDKANALEN INWAY GOULOTTES INWAY

Wandkanalen PVC
Goulotte PVC

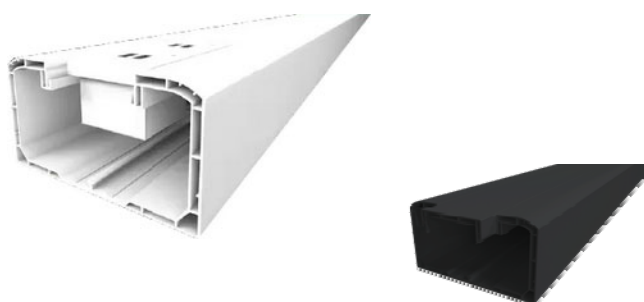



BESTELNUMMER N° DE COMMANDE	Afm. Dim.	Lengte Longueur	
IW10054B	100 x 54 mm	2m	12 m
IW10054BEK	100 x 54 mm	1,3m	7,8 m
IW10054BLACK	100 x 54 mm	2m	12 m
IW10054EKBLACK	100 x 54 mm	1,3m	7,8 m

Deksel inbegrepen
Couvercle inclus

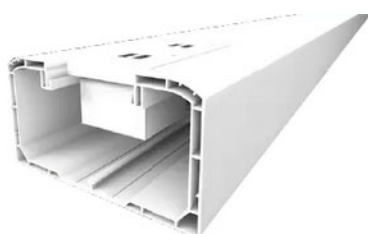

Wandkanalen PVC HF
Goulotte PVC HF



BESTELNUMMER N° DE COMMANDE	Afm. Dim.	RAL	
IW10054-HL	100 x 54 mm	RAL 9003	12 m

Deksel inbegrepen
Lengte : 2 meter
Couvercle inclus
Longueur : 2 mètres



WANDKANALEN INWAY GOULOTTES INWAY

Toebehoren Wandkanalen INWAY

Accessoires Goulottes Murales INWAY



BESTELNUMMER N° DE COMMANDE	Omschrijving	Description	
IWAE10054B	Verstelbare buitenhoek	Angle extérieur flexible	6
IWAI10054B	Verstelbare binnenhoek	Angle intérieur flexible	6
IWAP10054B	Vlakke hoek	Angle plat	8
IWGT10054B	T-stuk	Déviation-T	6
IWGU100	Verbinding voor basis en deksel	Joint pour base et couvercle	100
IWS10040B	Scheidings	Séparateur	8
IWTT10054B	Eindstuk	Embout	12
IWAE10054BLACK	Verstelbare buitenhoek	Angle extérieur flexible	6
IWAI10054BLACK	Verstelbare binnenhoek	Angle intérieur flexible	6
IWAP10054BLACK	Vlakke hoek	Angle plat	8
IWGT10054BLACK	T-stuk	Déviation-T	6
IWGU100BLACK	Verbinding voor basis en deksel	Joint pour base et couvercle	100
IWS10040BLACK	Scheidings	Séparateur	8
IWTT10054BLACK	Eindstuk	Embout	12



KABELGELEIDERS CONDUITS POUR CABLES

Spiralen Transparant
Spirales Transparent



BESTELNUMMER N° DE COMMANDE	∅	
CP03	3 mm	50 m
CP06	6 mm	25 m
CP08	8 mm	25 m
CP10	10 mm	25 m
CP12	12 mm	25 m
CP20	20 mm	10 m

Spiralen Zwart
Spirales Noir



BESTELNUMMER N° DE COMMANDE	∅	
CPN03	3 mm	50 m
CPN06	6 mm	25 m
CPN08	8 mm	25 m
CPN10	10 mm	25 m
CPN12	12 mm	25 m
CPN20	20 mm	10 m

Metalen flex buis
Tube flexible métallique



BESTELNUMMER N° DE COMMANDE	∅	
83120	∅ 9-12 mm	50 m
83140	∅ 11-14 mm	50 m
83170	∅ 14-17 mm	50 m
83210	∅ 18-21 mm	50 m
83240	∅ 20-24 mm	50 m
83300	∅ 26-30 mm	25 m
83410	∅ 37-41 mm	25 m

Polyester beschermkous
Gaine de protection polyesterè





BESTELNUMMER N° DE COMMANDE	∅	
Guest05	5-10 mm	200 m
Guest10	10-18 mm	200 m
Guest20	20-30 mm	100 m
Guest30	30-45 mm	100 m
Guest50	50-75 mm	50 m

KABELGELEIDERS CONDUITS POUR CABLES

Mini bedradingskanalen

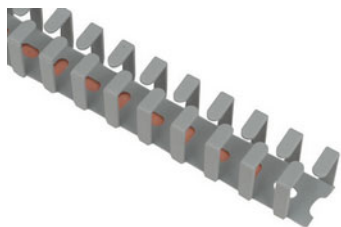
Canaux de câblage mini



BESTELNUMMER N° DE COMMANDE	Afm. Dim.	
FLX10	13 x 15 mm	25 m
FLX20	20 x 24 mm	25 m
FLX30	29 x 33 mm	25 m
FLX40	40 x 44 mm	25 m

Lengte / longueur : 500 mm

AARDINGSMATERIAAL MATERIEL DE MISE A LA TERRE

Aardstaven kruisvorm met vlag

Piquets de terre en forme de croix avec drapeau



BESTELNUMMER N° DE COMMANDE	Lengte Longueur	
AML511	1,0 m	5
AML512	1,5 m	5
AML513	2,0 m	5
AML514	2,5 m	5
AML515	3,0 m	5
AML512-E	1,5 m *	5

50 x 50 x 3 mm

Warm verzinkt / Galvanisé chaud

* Zonder vlag / Sans drapeau

Klemschroeven voor aardstaaf

Boulons de serrage pour piquet de terre

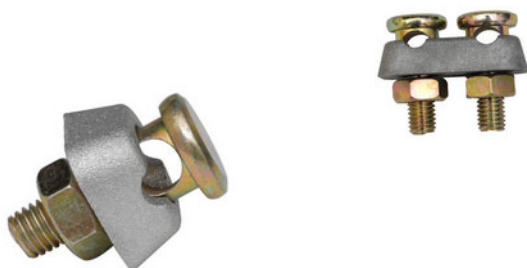

BESTELNUMMER N° DE COMMANDE	Omschrijving	Description	
AMM1	Enkel	Simple	10
AMM2	Dubbel	Double	10

Bandaardingsklemmen

Bandes pour mise à la terre



BESTELNUMMER N° DE COMMANDE	Afm. Dim.	
AM370	12 cm	10/300
AM371	19 cm	10/300
AM374	42 cm	10/200
AM376	58 cm	10/100
AM3712	19 cm*	10/100

Voor / Pour : 1 x 2,5 mm² à 2 x 6 mm²

Vernikkelde klem + schroef. Inox band.

Clame + écrous nickelées. Bande en inox.

* Dubbel Schroef / Double vis

AARDINGSMATERIAAL MATERIEL DE MISE A LA TERRE

Moerklemmen (Splitklemmen)

Connecteurs de dérivation



BESTELNUMMER N° DE COMMANDE	∅	
AM9200026	6 - 10 mm ²	100
AM9200027	16 mm ²	100
AM9200028	25 mm ²	100
AM9200029	35 mm ²	50
AM9200030	50 mm ²	50

Messing vernikkeld
Laiton nickelé

Aardstaven met kopermantel om te vijzen - 30 μ

Piquets manteau de cuivre pour visser - 30 μ



BESTELNUMMER N° DE COMMANDE	∅ IN	∅	Lengte Longueur	
AM117	14,2 mm	16 mm	1500 mm	10 / 500
AM118	14,2 mm	16 mm	2000 mm	10
AM127	16,0 mm	18 mm	1500 mm	10
AM128	16,0 mm	18 mm	2000 mm	10

Aardstaven met kopermantel om te vijzen - 100 μ

Piquets manteau de cuivre pour visser - 100 μ



BESTELNUMMER N° DE COMMANDE	∅ IN	∅	Lengte Longueur	
AM117-100	14,2 mm	16 mm	1500 mm	10 / 500
AM118-100	14,2 mm	16 mm	2000 mm	10
AM127-100	16,0 mm	18 mm	1500 mm	10
AM128-100	16,0 mm	18 mm	2000 mm	10

* Op aanvraag / Sur demande

Aardstaven met kopermantel om te vijzen - 250 μ*

Piquets manteau de cuivre pour visser - 250 μ*



BESTELNUMMER N° DE COMMANDE	∅ IN	∅	Lengte Longueur	
AM117-250	14,2 mm	16mm	1500 mm	*
AM118-250	14,2 mm	16mm	2000 mm	*

* Op aanvraag / Sur demande

AARDINGSMATERIAAL MATERIEL DE MISE A LA TERRE

Moffen om te vijzen
Manchons pour visser



BESTELNUMMER N° DE COMMANDE	∅	
AMM116	16 mm	1/130
AMM126	18 mm	1/120

Messing / Laiton

Aardstaven met kopermantel conisch - 30 μ
Piquets manteau cuivre conique - 30 μ



BESTELNUMMER N° DE COMMANDE	∅	Lengte Longueur	
AM114SS	14,0 mm	1500 mm	10 / 500

Moffen conisch
Manchons cône



BESTELNUMMER N° DE COMMANDE	∅	
AMM116-C	14 mm	1/100

Messing / Laiton

Klemmen
Clames



BESTELNUMMER N° DE COMMANDE	Specificiteit Spécificités	∅	
AMS116	*1	16 mm	1/250
AMS126	*1	18 mm	1/100
AMS116-2	*2	16 mm	1/300

*1 Messing / Laiton

*2 Verkoperd metaal / Acier cuivré

AARDINGSMATERIAAL MATERIEL DE MISE A LA TERRE

Handslagijzers
Têtes de frappe



BESTELNUMMER N° DE COMMANDE	∅	
AMT116	16 mm	1/100
AMT126	18 mm	1/100

Handslagbouten
Boulons de frappe



BESTELNUMMER N° DE COMMANDE	∅	
AMDS16	16 mm	1/100
AMDS18	18 mm	1/100

Aardingsonderbrekers + rail voor dito A
Coupures de terre + rail pour dito A



BESTELNUMMER N° DE COMMANDE	
AM0301	25

Aardingsonderbrekers + rail voor dito B
Coupures de terre + rail pour dito B



BESTELNUMMER N° DE COMMANDE	
AM0303	20

AARDINGSMATERIAAL MATERIEL DE MISE A LA TERRE

Aardingsonderbrekers + rail voor dito C

Coupires de terre + rail pour dito C



BESTELNUMMER N° DE COMMANDE	
AM0305	14

Klouw
Griffe



BESTELNUMMER N° DE COMMANDE	
AMK0310	100

Klouwklemmen
Borniers à griffes



BESTELNUMMER N° DE COMMANDE	Specificiteit Spécificités	ø	
AMCC1016	*1	< 16 mm ²	1
AMCC2550	*1	< 50 mm ²	1
AMCC-D-1016	*2	< 16 mm ²	1
AMCC-D-2550	*2	< 50 mm ²	1

*1 Enkel / Simple

*2 Dubbel / Double

C403



BESTELNUMMER N° DE COMMANDE	
C403	1/24

10/16A - IP44
Normes
250V - Norm7 - VD

C400



BESTELNUMMER N° DE COMMANDE	
C400	1/24

Norm 7 IP44 VDE
10/16 A
250 V

C310W
C310B



BESTELNUMMER N° DE COMMANDE	Specificiteit Spécificités	
C310B	Black	1/25
C310W	White	1/25

IP20 - 250V - IEC60884 - DIN49441
10/16 A
Rubber / Caoutchouc

C311W
C311B



BESTELNUMMER N° DE COMMANDE	Specificiteit Spécificités	
C311B	Black	1/24
C311W	White	1/24

IP20 - 250V - IEC60884 - DIN49441
IP20 - 250V - IEC60884 - DIN49441
10/16 A
Rubber / Caoutchouc

Stekkers Fiches

C300W

C300B



BESTELNUMMER N° DE COMMANDE	Specificiteit Spécificités	
C300B	Black	1/25
C300W	White	1/25

IP20 - 250V - IEC60884 - DIN49441
16 A
PVC

Stekker

Fiches plates



BESTELNUMMER N° DE COMMANDE	Specificiteit Spécificités	
C320B	Black	1/48
C320W	White	1/48
C321B	Black	1/48
C321W	White	1/48

320* 321*
Mannelijk Vrouwelijk
Mâle Femelle
PVC
10A - 250V - IEC 60884 - UNE ESC10a

CEE STEKKER PRISES CEE

Stekkers

Fiches mâles



BESTELNUMMER N° DE COMMANDE	A	Polen Poles	Spanning Tension	
9316-4	16 A	3	230 V	10
9416-4	16 A	4	400 V	10
9516-4	16 A	5	400 V	10
9332-4	32 A	3	230 V	10
9432-4	32 A	4	400 V	10
9532-4	32 A	5	400 V	10



Koppelstekkers

Fiches femelles



BESTELNUMMER N° DE COMMANDE	A	Polen Poles	Spanning Tension	
9316-3	16 A	3	230 V	10
9416-3	16 A	4	400 V	10
9516-3	16 A	5	380 V	10
9332-3	32 A	3	230 V	10
9432-3	32 A	4	400 V	10
9532-3	32 A	5	400 V	10



Wandozen

Prises murales



BESTELNUMMER N° DE COMMANDE	A	Polen Poles	Spanning Tension	
9316-2	16 A	3	230 V	10
9416-2	16 A	4	400 V	5
9516-2	16 A	5	400 V	5
9332-2	32 A	3	230 V	5
9432-2	32 A	4	400 V	5
9532-2	32 A	5	400 V	5



CEE STEKKER PRISES CEE

Inbouwdozen

Prises à encastrer



BESTELNUMMER N° DE COMMANDE	A	Polen Poles	Spanning Tension	
9316-1	16 A	3	230 V	10
9416-1	16 A	4	400 V	10
9516-1	16 A	5	400 V	10
9332-1	32 A	3	230 V	10
9432-1	32 A	4	400 V	10
9532-1	32 A	5	400 V	10



CEE STEKKERS - IP 67 PRISES CEE - IP 67

Stekkers

Fiches mâles



BESTELNUMMER N° DE COMMANDE	A	Polen Poles	Spanning Tension	
679316-4	16 A	3	250 V	10
679416-4	16 A	4	415 V	10
679516-4	16 A	5	415 V	10
679332-4	32 A	3	250 V	10
679432-4	32 A	4	415 V	10
679532-4	32 A	5	415 V	10
679363-8	63 A	3	250 V	1
679463-8	63 A	4	415 V	1
679563-8	63 A	5	415 V	1

IP67



Koppelstekkers

Fiches femelles



BESTELNUMMER N° DE COMMANDE	A	Polen Poles	Spanning Tension	
679316-3	16 A	3	250 V	10
679416-3	16 A	4	415 V	10
679516-3	16 A	5	415 V	10
679332-3	32 A	3	250 V	10
679432-3	32 A	4	415 V	10
679532-3	32 A	5	415 V	10
679363-7	63 A	3	250 V	1
679463-7	63 A	4	415 V	1
679563-7	63 A	5	415 V	1

IP67



Wanddozen

Prises murales



BESTELNUMMER N° DE COMMANDE	A	Polen Poles	Spanning Tension	
679316-2	16 A	3	250 V	10
679416-2	16 A	4	415 V	10
679516-2	16 A	5	415 V	10
679332-2	32 A	3	250 V	10

IP67



CEE STEKKERS - IP 67 PRISES CEE - IP 67

Wanddozen

Prises murales



BESTELNUMMER N° DE COMMANDE	A	Polen Poles	Spanning Tension	
679432-2	32 A	4	415 V	10
679532-2	32 A	5	415 V	10
679363-6	63 A	3	250 V	1
679463-6	63 A	4	415 V	1
679563-6	63 A	5	415 V	1

IP67



Inbouwdozen

Prises à encastrer



BESTELNUMMER N° DE COMMANDE	A	Polen Poles	Spanning Tension	
679316-1	16 A	3	250 V	10
679416-1	16 A	4	415 V	10
679516-1	16 A	5	415 V	10
679332-1	32 A	3	250 V	10
679432-1	32 A	4	415 V	10
679532-1	32 A	5	415 V	8
679363-5	63 A	3	250 V	2
679463-5	63 A	4	415 V	2
679563-5	63 A	5	415 V	2

IP67



W4-16



BESTELNUMMER N° DE COMMANDE	∅	
W4-16	4 - 16 mm ²	1/12

Met haakkling voor verwijdering van de isolatie.
Avec lame spéciale pour écarter l'isolation.

W8-28



BESTELNUMMER N° DE COMMANDE	∅	
W8-28	8 - 28 mm ²	1/12

Met haakkling voor verwijdering van de isolatie.
Avec lame spéciale pour écarter l'isolation.

W50



BESTELNUMMER N° DE COMMANDE	∅ IN	∅	
W50	35 - 50	35 - 50 mm ²	1/12

W1000



BESTELNUMMER N° DE COMMANDE	
W1000	1/12

Met haakkling voor verwijdering van de isolatie.
Avec lame spéciale pour écarter l'isolation.

WBLI28H4



BESTELNUMMER N° DE COMMANDE	∅	
WBLI28H4	4 - 28 mm	1/12

Met haakkling voor verwijdering van de isolatie.
Avec lame spéciale pour écarter l'isolation.

WBLIS428



BESTELNUMMER N° DE COMMANDE	∅	
WBLIS428	4 - 28 mm	1/12

Gemoderniseerde versie van de BLI28H. Met inklapbaar mes.
Version modernisée du BLI28H. Avec lame retractable,

W10



BESTELNUMMER N° DE COMMANDE	
W10	1

Vervangmesje voor 16 - 27 - 50 - BLI28H
Lame de réchange pour 16 - 27 - 50 - BLI28H

W10.1



BESTELNUMMER N° DE COMMANDE	
W10.1	1

Vervangmesje voor BLIS428
Lame de réchange pour BLIS428

W100



BESTELNUMMER N° DE COMMANDE	
W100	1/12

Ontmantelmes + striptang.
Couteau à démanteler + dénuder.

WBLI13



BESTELNUMMER N° DE COMMANDE	∅	
WBLI13	6 - 13 mm	1/12

Ontmantelingsmes ronde kabel van 3 x 1,5 mm tot 5 x 2,5 mm.

Buitendiameter : 6 tot 13 mm.

Couteau à démanteler pour câbles ronds de 3 x 1,5 mm² à 5 x 2,5 mm.

Diamètre extérieur : 6 à 13 mm.

W16



BESTELNUMMER N° DE COMMANDE	∅ IN	∅	
W16	4 - 16	8 - 13 mm ²	1/12

Quadro Ontmantelingsmes, haakmes inklapbaar, strippen 0,5 tot 6mm²

Quadro Couteau à démanteler, lame en crochet retractable, dénudeur

0,5 jusqu'à 6mm²

W30



BESTELNUMMER N° DE COMMANDE	∅	
W30	4 - 10 mm	1/12

Data - Strip Ontmantelingsmes voor data kabel, strippen 0,2 - 0,8mm²

Data Strip - Couteau à démanteler pour câble data, coupe-fil jusqu'à ∅ 8 mm, dénudeur 0,2 - 0,8 mm²

W25



BESTELNUMMER N° DE COMMANDE	∅	
W25	25 mm	1/6

Ontmantelingsmes voor grondkabel, Ø = 25mm (zowel dwars als in de lengte), tot manteldikte 5mm
 Couteau à demanteler pour cable de sol, Ø = 25 mm (circulaire et longitudinal), jusqu'à 5mm d'épaisseur

Striptang SUPER

Pince à dénuder SUPER



BESTELNUMMER N° DE COMMANDE	∅	
WBLI5	0,2-6 mm	1/6

Tang DUO CRIMP

Pince DUO CRIMP



BESTELNUMMER N° DE COMMANDE	∅	
W300	0,5-6 mm	1/6

MULTI-STRIPPER

MULTI-STRIPPER



BESTELNUMMER N° DE COMMANDE	∅	
W400	8-13 mm	1/6

GEREEDSCHAP OUTILLAGE

MULTI-STRIPPER PLUS
MULTI-STRIPPER PLUS



BESTELNUMMER N° DE COMMANDE	∅	
W500	0,5-6 mm	1/12

Strippen + knippen + krimpen.
Dénuder + couper +sertir.

Striptangen SOLAR
Pinces à dénuder SOLAR



BESTELNUMMER N° DE COMMANDE	∅	
WBLI3SOLAR	1,5 - 6 mm ²	1
WBLI7SOLAR	1,5 - 6 mm ²	1

Speciaal voor zonne-energie techniek.
Spécialement pour le technique énergie solaire.

Krimptangen voor geïsoleerde kabelschoenen
Pinces à sertir pour souliers de cable isolés



BESTELNUMMER N° DE COMMANDE	∅	
DHCR15	1,5 - 4 mm ²	1

Krimptang voor niet-geïsoleerde kabelschoenen
Pince à sertir pour souliers de cable non-isolés



BESTELNUMMER N° DE COMMANDE	∅	
DHC95	10 - 95 mm ²	1

GEREEDSCHAP OUTILLAGE

Buistang Voor het knippen van PVC-buizen 16 mm en 20 mm
Pince pour couper tubes Pour couper tubes en PVC de 16 mm et



BESTELNUMMER N° DE COMMANDE	
KT3204	1

Voor het knippen van PVC-buizen
16 mm en 20 mm.
Pour couper tubes en PVC de
16 mm et 20 mm.

Reserve onderbasis tang 3204
Base de rechange pour pince 3204



BESTELNUMMER N° DE COMMANDE	
KT3002-3204	1

Reservemesje tangen 3204 en 3704
Lame de rechange pour pinces 3204 et 3704



BESTELNUMMER N° DE COMMANDE	
KT3001	1

Flextang Voorbekabelde Ribbuis
Pince Pour Tube Flex



BESTELNUMMER N° DE COMMANDE	∅	
KT3704	16 - 20 mm (21 mm)	1

Voor ontmanteling van voorbekabelde ribbel-buis.
Pour démanteler tubes annelés pré-câblés.
16 - 20 mm (21 mm)

GEREEDSCHAP OUTILLAGE

Onderbasis Voor Tang 3704
Base Pour Pince 3704



BESTELNUMMER N° DE COMMANDE	
KT3002-3704	1

Reservemesje tangen 3204 en 3704
Lame de rechange pour pinces 3204 et 3704



BESTELNUMMER N° DE COMMANDE	
KT3001	1

Kanaaltang
Pince de canal



BESTELNUMMER N° DE COMMANDE	
KT3604	1

Spiraal ø 5,5 mm, versterkt Trekveren
Spirale ø 5,5 mm, renforcé tire-fils



BESTELNUMMER N° DE COMMANDE	Lengte Longueur	
305505	5 m	1/20
305510	10 m	1/15
305515	15 m	1/10
305520	20 m	1/8
305525	25 m	1/6
305530	30 m	1/5

Plat



BESTELNUMMER N° DE COMMANDE	Lengte Longueur	
11405	5 m	1/10
11410	10 m	1/10
11415	15 m	1/10
11420	20 m	1/10
11425	25 m	1/10
11430	30 m	1/10

Nylon dia. 4 mm



BESTELNUMMER N° DE COMMANDE	Lengte Longueur	
11605	5 m	1/25
11610	10 m	1/20
11615	15 m	1/12
11620	20 m	1/10
11625	25 m	1/8
11630	30 m	1/6

Glasfiber Fibre de verre



BESTELNUMMER N° DE COMMANDE	Lengte Longueur	PIC
37000	30 m	A
37010	50 m	A
37020	60 m	A
37030	80 m	A
37040	100 m	A
37050	60 m	A
37060	100 m	A
37070	120 m	A
37080	150 m	A
37090	30 m	B
37100	50 m	C
37110	60 m	C
37120	80 m	C
37130	100 m	C
37140	60 m	C
37150	100 m	C

Op bestelling / sur commande



GEREEDSCHAP OUTILLAGE

Glasfiber
Fibre de verre



BESTELNUMMER N° DE COMMANDE	Lengte Longueur	PIC
37160	120 m	C
37170	150 m	C

Op bestelling / sur commande



Spirado



BESTELNUMMER N° DE COMMANDE	
Spirado	1

Spiratrek



BESTELNUMMER N° DE COMMANDE	
Spiratrek	1

Buigveren
Ressorts à courber



BESTELNUMMER N° DE COMMANDE	ø	Lengte Longueur	
310816	16 mm	80 cm	1
310820	20 mm	80 cm	1
310825	25 mm	80 cm	1
311616	16 mm	160 cm	1
311620	20 mm	160 cm	1

Versterkte uitvoering.
Staaldraad 2 x 2 mm.
Exécution renforcée.
Fil en acier 2 x 2 mm.

GEREEDSCHAP OUTILLAGE

Buigveren

Ressorts à courber



BESTELNUMMER N° DE COMMANDE	∅	Lengte Longueur	
311625	25 mm	160 cm	1

Versterkte uitvoering.
Staaldraad 2 x 2 mm.
Exécution renforcée.
Fil en acier 2 x 2 mm.

Fitting in thermoplast E27
Soquet thermoplastique E27



Kelderverlichtingen
Hublots



BESTELNUMMER N° DE COMMANDE	
755	50 / 500



BESTELNUMMER N° DE COMMANDE	VERMOGEN PUISSANCE	
460	100 W	1/30
470	100 W	1/18
471	60 W	1/24

Voet : PVC
Glas : Polycarbonaat / onbreekbaar.
Pied : PVC
Verre : Polycarbonate / incassable



BEUGELS MET RUBBER COLLIERS ISOPHONIKES

Met Scharnier
Avec Charnière



BESTELNUMMER N° DE COMMANDE	∅	
PC0015	11-15 mm	100
PC0018	15-19 mm	100
PC0022	21-23 mm	100
PC0028	26-28 mm	100
PC0035	32-35 mm	100
PC0042	40-43 mm	50
PC0048	48-51 mm	50
PC0054	51-56 mm	50
PC0060	57-60 mm	50
PC0064	62-65 mm	50

Snelmontage met rubber
Fixation rapide avec caoutchouc

Met twee vijzen
Avec deux vis



BESTELNUMMER N° DE COMMANDE	∅	
PC1075	75-80 mm	25
PC1090	87-92 mm	25
PC1100	99-105 mm	25
PC1110	107-112 mm	25
PC1115	113-118 mm	25
PC1125	125-130 mm	25
PC1133	132-137 mm	25
PC1140	138-142 mm	25
PC1150	148-152 mm	25
PC1160	159-166 mm	25

METALEN KANALEN CHEMINS DE CÂBLE EN METAL

Metalen kanalen geperforeerd
Chemins de câble perforés

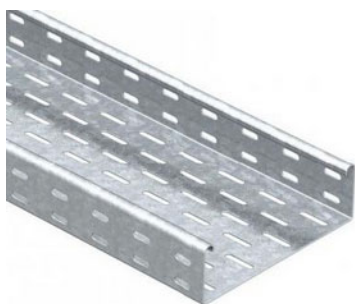

BESTELNUMMER N° DE COMMANDE	Afm. Dim.	
MT6075075	60x75x0,75mm	24 m
MT60100075	60x100x0,75mm	18 m
MT60100100	60x100x1,00mm	18 m
MT60200075	60x200x0,75mm	18 m
MT60200100	60x200x1,00mm	12 m
MT60300075	60x300x0,75mm	12 m
MT60300100	60x300x1,00mm	12 m

LIJST VAN DE TOEBEHOREN - ZIE WWW.GSV.BE
LISTE DES ACCESSOIRES - SUR WWW.GSV.BE
Lengte/Longueur : 3 m

Niet Geperforeerd Kabelgoot
Chemin De Cable Non Perforé



BESTELNUMMER N° DE COMMANDE	Afm. Dim.	
MTN60100075	60x100x0,75mm	18 m
MTN60100100	60x100x1,00mm	18 m
MTN60200075	60x200x0,75mm	12 m
MTN60200100	60x200x1,00mm	12 m
MTN60300075	60x300x0,75mm	12 m
MTN60300100	60x300x1,00mm	12 m

LIJST VAN DE TOEBEHOREN - ZIE WWW.GSV.BE
LISTE DES ACCESSOIRES - SUR WWW.GSV.BE
Lengte/Longueur : 3 m

Draadgoten Easy Connect
Chemins de câble Easy Connect

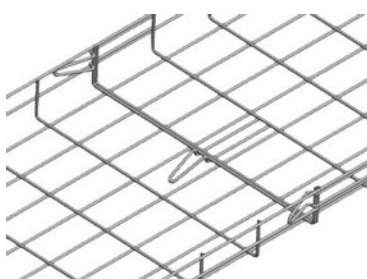

BESTELNUMMER N° DE COMMANDE	Afm. Dim.	
EC60060EZ	60x060mm	36 / 1008 m
EC60100EZ	60x100mm	24 / 924 m
EC60150EZ	60x150mm	18 / 630 m
EC60200EZ	60x200mm	12/24/498 m
EC60300EZ	60x300mm	12 / 324 m
EC60400EZ	60x400mm	12 / 240 m
EC60500EZ	60x500mm	6 / 204 m

Standaard uitvoering / Finition standard
Quick Connection: met snelkoppeling / avec connexion rapide
LIJST VAN DE TOEBEHOREN - ZIE WWW.GSV.BE
LISTE DES ACCESSOIRES - SUR WWW.GSV.BE
Beschikbaar in RVS / Hot Deep Galvanised
Disponible en Inox /Hot Deep Galvanised



METALEN KANALEN CHEMINS DE CÂBLE EN METAL

Draadgoten Easy Connect
Chemins de câble Easy Connect

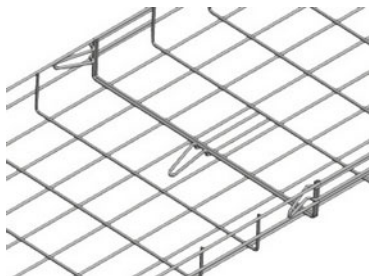

BESTELNUMMER N° DE COMMANDE	Afm. Dim.	
EC60600EZ	60x600mm	6 / 180 m

Standaard uitvoering / Finition standard
Quick Connection: met snelkoppeling / avec connexion rapide
LIJST VAN DE TOEBEHOREN - ZIE WWW.GSV.BE
LISTE DES ACCESSOIRES - SUR WWW.GSV.BE
Beschikbaar in RVS / Hot Deep Galvanised
Disponible en Inox /Hot Deep Galvanised



C - Beugel voor plafond
Fixation en C pour plafond



BESTELNUMMER N° DE COMMANDE	Afm. Dim.	
SOPC10SG	180x115x215mm	8
SOPC15SG	180x115x265mm	8
SOPC20SG	180x115x315mm	8
SOPC30SG	180x115x415mm	8



L - beugel voor Wand
Fixation en L Murale

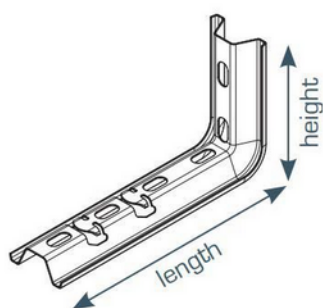



BESTELNUMMER N° DE COMMANDE	Afm. Dim.	
SOC10SG	115x215mm	10
SOC15SG	115x265mm	10
SOC20SG	115x315mm	10
SOC30SG	115x415mm	10

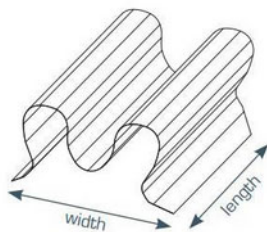

METALEN KANALEN CHEMINS DE CÂBLE EN METAL

Snel Verbinder
Connecteur Rapide



BESTELNUMMER N° DE COMMANDE	Afm. Dim.	
MCLIC	13x23mm	100

Index

0

010TARM016 30
 010TARM020 30
 010TARM025 30
 010TARM032 30
 010TARM040 30
 010TARM050 30
 010TARM063 30
 020CARM016 31
 020CARM020 31
 020CARM025 31
 020CARM032 31
 020CARM040 31
 020CARM050 31
 020CARM063 31
 020MARM016 31
 020MARM020 31
 020MARM025 31
 020MARM032 31
 020MARM040 31
 020MARM050 31
 020MARM063 31
 031G 44
 031T 44
 040CDTM254 16
 040CDTM255 16
 040CDTM256 16
 040CDTM257 16
 040CDTM258 16

1

10012 64
 108 43
 11405 126
 11410 126
 11415 126
 11420 126
 11425 126
 11430 126
 11605 126
 11610 126
 11615 126
 11620 126
 11625 126
 11630 126

2

2012 69
 2014 69
 2016 69
 2035 43
 2036 43
 2036 Black ... 33
 2036 D 44
 2037 43
 2037 Black ... 33
 2037 D 44
 2038 43
 2039 43
 204 43
 204 Black 32
 204 D 44
 204 White 32
 20436 44
 2047 46
 2048 46
 2050 47
 2051 47
 208 43
 208 BLACK .. 32
 209 43

2

20BLI 96
 210 43
 211 43
 211 D 44
 215 62
 219B 9
 220A 8
 220AM 8
 220B 9
 222A 8
 222AM 8
 222B 9
 223A 8
 223AM 8
 223ATA 8
 223ATAM 8
 223B 9
 223BTA 9
 223LTATR 11
 224A 8
 224AM 8
 224B 9
 224LTR 11
 226B 9
 250001 63
 250002 63
 250005 63
 250-11AM 22
 250-5AM 22
 250-9AM 22
 250-9B 22
 251001 63
 251001C 63
 251002 63
 251002C 63
 273MF 22
 2761 66
 28.41 11
 28.43 11
 28.43-PLEXI . 11
 28.51 11
 28.53 12
 28.61 11

3

3004-18 58
 3005-18 58
 3006-18 58
 300620W 59
 3007-18 58
 3007-18BLACI 35, 58
 300720W 59
 3008-20 58
 3009-20 58
 3010-35 58
 3011-35 58
 3012-35 58
 3014-40 58
 3016-40 58
 3018-40 58
 3020-40 58
 305505 125
 305510 125
 305515 125
 305520 125
 305525 125
 305530 125
 310816 127
 310820 127
 310825 127

3

311616 127
 311620 127
 311625 128
 316 20
 318 20
 350001 63
 350002 63
 37000 126
 37010 126
 37020 126
 37030 126
 37040 126
 37050 126
 37060 126
 37070 126
 37080 126
 37090 126
 37100 126
 37110 126
 37120 126
 37130 126
 37140 126
 37150 126
 37160 127
 37170 127
 397-5 18
 398-5 18
 399-5 18

4

411620 60
 41E 95, 102
 41G 95
 41I 95
 41L 95
 41S 95
 41T 95
 424 19
 426 19
 428 19
 429 19
 430 19
 430V 20
 431 19
 431V 20
 44E 95, 102
 44I 95
 44L 95
 44LG 95
 44LT 95
 4570 70
 460 129
 470 129
 471 129

5

501018 64
 501025 64
 501030 64
 501040 64
 50704 17
 50706 17
 50710 17
 50716 17
 50725 17
 512 45
 512-2 45
 513 45
 513-2 45
 515 45

5

515-2 45
 516 45
 516-2 45
 517 45
 517-2 45
 518 45
 518-2 45
 519 45
 520 45
 5605-16 52
 5605-22 52
 5605-28 52
 5605-38 52
 5605-50 52
 5605-60 52
 5720 68
 5721 68
 5722 68
 5725 68
 5726 68
 5727 68

6

601620 60
 601922 60
 602125 60
 611620 60
 611922 60
 612125 60
 679316-1 118
 679316-2 117
 679316-3 117
 679316-4 117
 679332-1 118
 679332-2 117
 679332-3 117
 679332-4 117
 679363-5 118
 679363-6 118
 679363-7 117
 679363-8 117
 679416-1 118
 679416-2 117
 679416-3 117
 679416-4 117
 679432-1 118
 679432-2 118
 679432-3 117
 679432-4 117
 679463-5 118
 679463-6 118
 679463-7 117
 679463-8 117
 679516-1 118
 679516-2 117
 679516-3 117
 679516-4 117
 679532-1 118
 679532-2 118
 679532-3 117
 679532-4 117
 679563-5 118
 679563-6 118
 679563-7 117
 679563-8 117

7

700-02 58
 700-05 58
 700-08 58

Index

7

700-08 BLACK 58
700-11 58
700-16 58
700-23 58
701516 47
701920 47
702-0 59
702-1 59
702-2 59
702225 47
702-2W 34
702-3 59
702-3W 34
703235 47
710-15 47
710-30 47
745-4C LG ... 25
745-8C LG ... 25
745-EPS4M .. 25
745-EPS8M .. 25
745-LAN 25
755 129
761 66

8

83120 106
83140 106
83170 106
83210 106
83240 106
83300 106
83410 106

9

9004121 56
9004510 56
905 45
90507 36
90509 36
90511 36
90513 36
90516 36
90521 36
90529 36
90536 36
90548 36
905M12-DMRI 38
905M16-DMRI 38
905M20-DMRI 38
905M25-DMRI 38
906 45
90607 37
90609 37
90611 37
90613 37
90616 37
906-2 46
90621 37
90629 37
90636 37
90648 37
907 45
90707 37
90709 37
90711 37
90713 37
90716 37
90721 37
90729 37
90736 37

9

90748 37
907M12 40
907M16 40
907M20 40
907M20 Black 32
907M25 40
907M32 40
907M40 40
907M50 40
907M63 40
908 45
908M16 40
908M20 40
908M25 40
908M32 40
908M40 40
908M50 40
908M63 40
909M16 41
909M20 41
90HS4 64
90HSM6 64
90HSXXX 64
9100001 48
9100002 48
9100004 48
9100005 48
9100007 48
9100026 48
9100029 48
9100030 48
9100031 49
9100037 49
9100038 49
9100046 49
9100047 49
9100056 50
9100057 50
9100066 49
9100067 49
9100116 49
9100120 49
9100126 49
9100132 49
9100140 49
9100150 49
9100707 49
9100900 48
9100903 50
9200900 67
9316-1 116
9316-2 115
9316-3 115
9316-4 115
9332-1 116
9332-2 115
9332-3 115
9332-4 115
9401001 62
9401051 68
9401052 69
9416-1 116
9416-2 115
9416-3 115
9416-4 115
9421 70
9422 70
9423 70
9424 70

9

9432-1 116
9432-2 115
9432-3 115
9432-4 115
950418 64
9516-1 116
9516-2 115
9516-3 115
9516-4 115
9532-1 116
9532-2 115
9532-3 115
9532-4 115
960418 64
9700012 47
9700016 47
9700020 47
9700025 47
9700028 47
9700316 48
9700320 48
9700325 48
9700806 51
9700808 51
9700810 51
9700812 51
9700814 51
9700816 51
9700817 52
9700819 51
9700820 52
9700825 51
9700826 51
9700828 51
9700830 51
9700832 51
9700834 51
9700836 51
9700839 51
9700845 51
9700850 51
9700855 51
9700860 51
9700875 52
9700880 52
9700916 49
9700920 49
9700925 49
9701016 48
9701020 48
9701025 48
9702816 51
9702817 52
9702819 51
9702820 52
9702836 51
9702839 51
9707-ORL01 . 36
9709-ORL02 . 36
9711-ORL03 . 36
9713-ORL04 . 36
9716-ORL05 . 36
9721-ORL06 . 36
9729-ORL07 . 36
9736-ORL08 . 36
9748-ORL10 . 36

A

AM0301 111
AM0303 111

A

AM0305 112
AM114SS 110
AM117 109
AM117-100 ... 109
AM117-250 ... 109
AM118 109
AM118-100 ... 109
AM118-250 ... 109
AM127 109
AM127-100 ... 109
AM128 109
AM128-100 ... 109
AM370 108
AM371 108
AM3712 108
AM374 108
AM376 108
AM9200026 .. 109
AM9200027 .. 109
AM9200028 .. 109
AM9200029 .. 109
AM9200030 .. 109
AMCC1016 112
AMCC2550 ... 112
AMCC-D-1016 112
AMCC-D-2550 112
AMDS16 111
AMDS18 111
AMK0310 112
AML511 108
AML512 108
AML512-E 108
AML513 108
AML514 108
AML515 108
AMM1 108
AMM116 110
AMM116-C ... 110
AMM126 110
AMM2 108
AMS116 110
AMS116-2 ... 110
AMS126 110
AMT116 111
AMT126 111

B

BA43-06 62
BA43-08 62
BA43-10 62
BA43-12 62
BM12 38
BM16 38
BM20 38
BM20 Black .. 33
BM20 White . 33
BM20LA 15
BM25 38
BM25LA 15
BM32 38
BM40 38
BM50 38
BM63 38
BS11BEU 92
BS21BEU 92
BS61BEU 92

C

C16VD 29
C16VD R 29

Index

C

C20VD 29
 C20VD R 29
 C25VD 29
 C25VD R 29
 C300B 114
 C300W 114
 C310B 113
 C310W 113
 C311B 113
 C311W 113
 C320B 114
 C320W 114
 C321B 114
 C321W 114
 C32VD 29
 C32VD R 29
 C400 113
 C403 113
 C40VD 29
 C40VD R 29
 C500 23
 C50VD 29
 C50VD R 29
 CD12-11DT .. 55
 CD12-14DT .. 55
 CD12-18DT .. 55
 CD12-24DT .. 55
 CD12-30DT .. 56
 CD12-9DT ... 55
 CD4-11DT 55
 CD4-14DT 55
 CD4-18DT 55
 CD4-24DT 55
 CD4-30DT 55
 CD4-9DT 55
 CD7-5-11DT . 55
 CD7-5-14DT . 55
 CD7-5-18DT . 55
 CD7-5-24DT . 55
 CD7-5-30DT . 55
 CD7-5-9DT ... 55
 CFR748 25
 CLT102110R 76
 CLT102116R 76
 CLT102129R 76
 CLT102149R 76
 CON125 91
 CON125M 91
 CON30 91
 CON30M 91
 CON70 91
 CON70M 91
 CON90 91
 CON90M 91
 CP03 106
 CP06 106
 CP08 106
 CP10 106
 CP12 106
 CP20 106
 CPN03 106
 CPN06 106
 CPN08 106
 CPN10 106
 CPN12 106
 CPN20 106

D

D006/04 78
 D006/05 78

D

D006/06 78
 D006/08 78
 D010/05 78
 D010/06 78
 D010/08 78
 D010/10 78
 D016/05 78
 D016/06 78
 D016/08 78
 D016/10 78
 D025/05 78
 D025/06 78
 D025/08 78
 D025/10 78
 D035/06 78
 D035/08 78
 D035/10 78
 D035/12 78
 D050/06 78
 D050/08 78
 D050/10 78
 D050/12 78
 D070/08 78
 D070/10 78
 D070/12 78
 D070/14 78
 D095/08 78
 D095/10 78
 D095/12 78
 D095/14 78
 D120/10 78
 D120/12 78
 D120/14 78
 D150/08 78
 D150/10 78
 D150/12 78
 D150/14 78
 D185/10 78
 D185/12 78
 D185/14 78
 D240/10 78
 D240/12 78
 D240/14 79
 D240/16 79
 D240/20 79
 D300/12 79
 D300/14 79
 D300/16 79
 DB02 79
 DB04 79
 DB06 79
 DB10 79
 DB120 79
 DB150 79
 DB16 79
 DB185 79
 DB240 79
 DB25 79
 DB35 79
 DB50 79
 DB70 79
 DB95 79
 DHC95 123
 DHCR15 123
 DVAB1F 80
 DVAB1M 80
 DVAB2F 81
 DVAB2M 81
 DVBC 5 82

D

DVBC1 80
 DVBC2 81
 DVF1/03 80
 DVF1/03.7 ... 80
 DVF1/04 80
 DVF1/05 80
 DVF1/06 80
 DVF2/03 81
 DVF2/03.7 ... 81
 DVF2/04 81
 DVF2/05 81
 DVF2/06 81
 DVF5/ 03 82
 DVF5/ 04 82
 DVF5/05 82
 DVF5/06 82
 DVF5/08 82
 DVFP O5 /6.3I 82
 DVFP O5 /9.5I 82
 DVFPO1/2.8F 80
 DVFPO1/4.8F 80
 DVFPO1/6.3F 80
 DVFPO2/4.8F 81
 DVFPO2/6.3F 81
 DVP 5/ 1 4 82
 DVP O 5 /6 .3 82
 DVP O 5 /6 .3 82
 DVP O 5 /9 .5 82
 DVP1/09 80
 DVP1/12 80
 DVP2/09 81
 DVP2/12 81
 DVPO1/2.8F . 80
 DVPO1/4.8F . 80
 DVPO1/4.8M 80
 DVPO1/6.3F . 80
 DVPO1/6.3M 80
 DVPO2/2.8F . 81
 DVPO2/4.8F . 81
 DVPO2/4.8M 81
 DVPO2/6.3F . 81
 DVPO2/6.3M 81
 DVPOA1/6.3 . 80
 DVPOA2/6.3 . 81
 DVR1/03 80
 DVR1/03.7 ... 80
 DVR1/04 80
 DVR1/05 80
 DVR1/06 80
 DVR1/08 80
 DVR1/10 80
 DVR1/12 80
 DVR2/03 81
 DVR2/03.7 ... 81
 DVR2/04 81
 DVR2/05 81
 DVR2/06 81
 DVR2/08 81
 DVR2/10 81
 DVR2/12 81
 DVR5/03 82
 DVR5/03.7 ... 82
 DVR5/04 82
 DVR5/05 82
 DVR5/06 82
 DVR5/08 82
 DVR5/10 82
 DVR5/12 82
 DVR5/14 82

D

DVR5/16 82

E

E10 85
 E104 87
 E11 85
 E114 87
 E12 85
 E120 69, 70
 E124 87
 E13 85
 E134 87
 E14 85
 E144 87
 E15 85
 E154 87
 E16 85
 E164 87
 E17 85
 E174 87
 E18 86
 E184 87
 E19 85
 E194 87
 E20 85
 E22 85
 E23 85
 E24 85
 E25 85
 E26 85
 E264 87
 E27 85
 E28 85
 E30 85
 E31 85
 E32 86
 E324 87
 E33 86
 E34 86
 E344 87
 E35 86
 E354 87
 E36 86
 E364 87
 E37 86
 E374 87
 E38 86
 E39 86
 E4 85
 E40 86
 E43 86
 E44 87
 E48 86
 E5 85
 E54 87
 E6 85
 E60 52
 E64 87
 E7 85
 E74 87
 E8 85
 E84 87
 E9 85
 E90 15, 51, 52, 68,
 69, 131, 132
 E94 87
 EASY02 7
 EASY04 7
 EASY08 7
 EASY12 7

Index

E

EASY18 7
 EC16 30
 EC16 R 30
 EC20 30
 EC20 Black .. 34
 EC20 R 30
 EC20 White .. 34
 EC25 30
 EC25 R 30
 EC60060EZ .. 131
 EC60100EZ .. 131
 EC60150EZ .. 131
 EC60200EZ .. 131
 EC60300EZ .. 131
 EC60400EZ .. 131
 EC60500EZ .. 131
 EC60600EZ .. 132
 ECICTA20HFT 28
 ECUT 89
 ED10050 86
 ED10075 86
 ED12575 86
 ED2525 86
 ED2537 86
 ED2550 86
 ED2575 86
 ED3737 86
 ED3750 86
 ED3775 86
 ED5050 86
 ED5075 86
 ED7550 86
 ED7575 86
 ERFE20G 28
 ERFE25G 28

F

FCV12040 90
 FCV12060 90
 FE12 13
 FE15 13
 FE25 13
 FE25 Black ... 34
 FE25 White .. 34
 FE7 13
 FE7 BLACK .. 34
 FH10-BRDT . 54
 FH10-DT 53
 FH10-ICA10D 53
 FH10-ICA6DT 53
 FH10-ICA8DT 53
 FH15-BRDT . 54
 FH15-DT 53
 FH15-ICA10D 53
 FH15-ICA6DT 53
 FH15-ICA8DT 53
 FH20-BRDT . 54
 FH20-DT 53
 FH20-ICA10D 53
 FH20-ICA6DT 53
 FH20-ICA8DT 53
 FH4-BRDT ... 54
 FH4-DT 53
 FH4-ICA10DT 53
 FH4-ICA6DT 53
 FH4-ICA8DT 53
 FLX10 107
 FLX20 107
 FLX30 107
 FLX40 107

F

FU12-5DT 54
 FU12-5TM6DT 54
 FU12-5TM8DT 54
 FU20DT 54
 FU20TM6DT 54
 FU20TM8DT 54
 FU7DT 54
 FU7TM6DT .. 54
 FU7TM8DT .. 54

G

G10 83
 G10BEU 84
 G11 83
 G12 83
 G13 83
 G14 83
 G15 83
 G16 83
 G16BEU 84
 G17 83
 G17BEU 84
 G18 83
 G19 83
 G19BEU 84
 G20BEU 94
 G23 83
 G23BEU 84
 G24 83
 G26 83
 G27 83
 G27BEU 84
 G28 83
 G30 83
 G30BEU 84
 G31 83
 G31BEU 84
 G31EKBEU .. 84
 G31KBEU 85
 G32 83
 G33 83
 G33BEU 84
 G35 83
 G37 83
 G38 83
 G39 83
 G4 83
 G40 83
 G40BEU 84
 G40EKBEU .. 84
 G41BEU 94
 G43 83
 G44BEU 94
 G45BEU 94
 G48 83
 G48BEU 84
 G4BEU 84
 G5 83
 G50 83
 G50BEU 84
 G50EKBEU .. 84
 G50KBEU 85
 G6 83
 G6BEU 84
 G7 83
 G8 83
 G8BEU 84
 G9 83
 G9BEU 84
 GCOP025 89

G

GCOP040 89
 GCOP060 89
 GCOP080 89
 GCOP100 89
 GCOP100BEL 90
 GCOP120 89
 GCOP120BEL 90
 GCOP150 89
 GCOP150BEL 90
 GCOP20 89
 GCOP200BEL 90
 GT16A 95
 GT248AB 95
 GT248EB 95, 102
 GT248GB 95
 GT248IB 95
 GT248LB 95
 GT248TB 95
 Guest05 106
 Guest10 106
 Guest20 106
 Guest30 106
 Guest50 106

H

HB0050 69
 HB0060 69
 HB0070 69
 HB0080 69
 HB0100 69
 HB0120 69
 HB0150 69
 HB0180 69
 HF 8, 9, 10, 11, 12,
 13, 14, 15, 17,
 19, 20, 21, 22,
 23, 25, 27, 28,
 29, 30, 32, 33,
 34, 35, 36, 37,
 38, 39, 40, 41,
 43, 44, 45, 46,
 47, 58, 59, 60,
 71, 72, 73, 74,
 75, 76, 77, 88,
 97, 98, 99, 100,
 104, 105, 115,
 116, 117, 118,
 129

I

IW10054B 104
 IW10054BEK 104
 IW10054BLAC 104
 IW10054EKBL 104
 IW10054-HL . 104
 IW20125LH .. 97
 IW2020LH 97
 IW6040LH 97
 IWAE10054B 105
 IWAE10054BL 105
 IWAI10054B . 105
 IWAI10054BL/ 105
 IWAP10054B 105
 IWAP10054BL 105
 IWGT10054B 105
 IWGT10054BL 105
 IWGU100 105
 IWGU100BLA/ 105
 IWS10040B .. 105
 IWS10040BLA 105
 IWTT10054B 105
 IWTT10054BL 105

I

IZ10/2F/54 24
 IZ10/3F/54 24
 IZ16/2F/54 24
 IZ16/3F/54 24
 IZ16/4F/56 24
 IZS10/3F/54 . 24
 IZS16/2F/54 . 24
 IZS16/3F/54 . 24
 IZS16/4F/56 . 24

J

J100B 9
 J100BF 15
 J100L 9
 J100S 8
 J100S Black . 33
 J100S CONNE 8
 J100S White 33
 J100SF 15
 J1207PAD 92
 J1602 15
 J160B 9
 J160BF 15
 J160L 9
 J1610PAD 92
 J200B 9
 J200BF 15
 J200L 9
 J2021 15
 J273-3 17
 J273-4 17
 J273-5 17
 J402 15
 J80B 9
 J80L 9

K

KP642L 19
 KP643L 19
 KP644L 19
 KP64-50-2LD 19
 KP64-50-3LD 19
 KP64-50-4LD 19
 KP64-50LD ... 19
 KP645L 19
 KP64-60LD ... 19
 KP64LD 19
 KT3001 124, 125
 KT3002-3204 124
 KT3002-3704 125
 KT3204 124
 KT3604 125
 KT3704 124

L

LD075ABEU . 103
 LD075EBEU . 102
 LD075IBEU .. 102
 LD075LBEU . 103
 LD075TBEU . 103
 LD105EBEU . 102
 LD105LBEU . 103
 LD105TBEU . 103
 LD125EBEU . 102
 LD125IBEU .. 102
 LD125LBEU . 103
 LD125TBEU . 103
 LDJ01 5
 LHD2010HF . 97
 LHD2020HF . 97
 LHD4020HF . 97

Index

L

LHD4040HF . 97
LHD8623HF . 103
LHD8624HF . 103
LHD8625HF . 102
LHD8626HF . 102
LHD8633HF . 103
LHD8634HF . 103
LHD8635HF . 102
LHD8636HF . 102
LHD8643HF . 103
LHD8644HF . 103
LHD8645HF . 102
LHD8646HF . 102
LHD8923HF . 103
LHD8924HF . 103
LHD8925HF . 102
LHD8926HF . 102

M

M001CS 14
M002CS 14
M003CS 14
M005CS 14
M013 100
M039 98
M040 98
M040HF 103
M041 98
M041037 98
M042 103
M042037 103
M043 99
M047001 99
M047002 99
M047003 99
M047004 99
M0478001 99
M050 99
M10037 98
M10050 98
M400047001 93
M400047002 93
M400047003 93
M40017 92
M40039 93
M40040 93
M40041 93
M40042 93
M40043 93
M40044 93
M512 46
M512-2 46
M515 46
M515-2 46
M518 46
M518-2 46
M522 46
M522-2 46
MCLIC 133
ME1216 41
ME1620 41
ME2025 41
ME2532 41
ME3240 41
MET22102R . 75
MET22105R . 75
MET22110R . 75
MET22111R . 75
MET22112R . 75
MET22123R . 75

M

MET22126R . 75
MET22140R . 75
MET22534R . 75
MET32102R . 75
MET32105R . 75
MET32110R . 75
MET32111R . 75
MET32112R . 75
MET32123R . 75
MET32126R . 75
MET32140R . 75
MET32326R . 75
MET32534R . 76
MF001 2
MF002 2
MF111 76
MF242 11
MIB16 10
MIB21 10
MIB29 10
MIBR Black .. 32
MIBR White .. 32
MIBR1620 30
MJB112 5
MJB113 5
MJB215 5
MJB222 6
MJB332 6
MP0030 3
MP0100 3
MP1000 3
MP2200 3
MPONE GEL 3
MR1612 41
MR2012 41
MR2016 41
MR2512 41
MR2516 41
MR2520 41
MR3212 41
MR3216 41
MR3220 41
MR3225 41
MR4016 41
MR4020 41
MR4025 41
MR4032 41
MR5020 41
MR5025 42
MR5032 42
MR5040 42
MR6325 42
MR6332 42
MR6340 42
MR6350 42
MT60100075 131
MT60100100 131
MT60200075 131
MT60200100 131
MT60300075 131
MT60300100 131
MT6075075 .. 131
MTN60100075 131
MTN6010010C 131
MTN60200075 131
MTN6020010C 131
MTN60300075 131
MTN6030010C 131

N

N12-C 21
N12-D 22
N18-C 21
N24-C 21
N24-D 22
N2x18-C 21
N36-C 21
N36-D 22
N3x18-C 21
N48-C 21
N4-C 21
N4-D 21
N4x18-C 21
N8-C 21
N8-D 21
NEW 2, 104, 126

O

OL70211 59
OL70212 59
OL70213 59
OL70214 59
OL70215 59
OL70216 59
OL70217 59
OL70218 59
OMBG01 42
OMBG02 42
OMBG03 42
OMBG04 42
OMBG05 42
OMBG06 42
OMBG07 42
OMBG08 42
OMBL01 42
OMBL02 42
OMBL03 42
OMBL04 42
OMBL05 42
OMBL06 42
OMBL07 42
OMBL08 42
OMRL03 M16 39
OMRL05 M20 39
OMRL05A7 .. 38
OMRL09 M50 39
OMRL10 M63 39
OMSL01 39
OMSL02 39
OMSL03 39
OMSL04 39
OMSL05 39
OMSL06 40
OMSL07 40
OMSL08 40

P

P1ES 62
P2ES 62
P3ES 62
PC0015 130
PC0018 130
PC0022 130
PC0028 130
PC0035 130
PC0042 130
PC0048 130
PC0054 130
PC0060 130
PC0064 130

P

PC1075 130
PC1090 130
PC1100 130
PC1110 130
PC1115 130
PC1125 130
PC1133 130
PC1140 130
PC1150 130
PC1160 130
PD15ZF4 66
PD32ZF6 66
PD35CZ 66
PD35CZF6 ... 66
PD35Z 66
PD35ZF6 66
PDTR2M 66
PICSHARK68(5
PICSHARK68(5
PICSHARK68(5
PICSHARK68(5
PICSHARK68(5
PIN003-CTTN 75
PIN005 74
PIN006-CTTS 75
PM12 39
PM16 39
PM20 39
PM25 39
PM32 39
PM40 39
PM50 39
PM63 39
PRRIV1 88
PRRIV2 88
PTR 87

R

RH18S 22
RH36/2S 22
RH54/3S 22
RH72/4S 22
RIV1 88
RIV2 88
RS150 3
RS1650 3
RS300 3
RS400 3
RS550 3
RS650 3

S

S1 90
S2 90
SAE160BEU . 102
SAI160BEU .. 102
SAP160BEU . 103
SB17-11DT ... 55
SCO45 101
SDK3 17
SDK5 17
SDK8 17
SDKF2TR-AN 17
SDKF3TR-AN 17
SDKF5TR-AN 17
SEL.10.202R 73
SEL.10.210R 73
SEL.10.223R 73
SEL.10.425R 73

Index

S

SEL.11.202R 73
SEL.11.210R 73
SEL.11.223R 73
SEL.11.425R 73
SEL.12.202R 73
SEL.12.210R 73
SEL.12.223R 73
SEL.12.425R 73
SEL.14.202R 73
SEL.14.210R 73
SEL.14.223R 73
SEL.14.425R 73
SEL.2.202T .. 73
SEL101 77
SEL2142 72
SEL2143 72
SEL2144 72
SEL2155 72
SEL2201 72
SEL2202 72
SEL2203 72
SEL2204 72
SEL2205 72
SEL2210 72
SEL2211 72
SEL2212 72
SEL2214 72
SEL2216 72
SEL2220 72
SEL2221 72
SEL2222 72
SEL2223 72
SEL2224 72
SEL2401 77
SEL2402 77
SEL2403 77
SEL2425 72
SEL2426 72
SEL2427 72
SEL2428 72
SEL2429 72
SEL2430 72
SEL2431 72
SEL2432 72
SEL2433 72
SEL2434 72
SEL2435 71, 72
SEL2436 72
SEL2438 72
SEL2441 72
SEL2450 72
SEL2451 72
SEL2452 72
SEL2453 72
SEL2501 76
SEL2502 76
SEL3142 71
SEL3143 71
SEL3144 71
SEL3150 71
SEL3155 71
SEL3201 71
SEL3202 71
SEL3203 71
SEL3204 71
SEL3205 71
SEL3210 71
SEL3211 71
SEL3212 71

S

SEL3214 71
SEL3215 72
SEL3216 71
SEL3220 71
SEL3221 71
SEL3222 71
SEL3223 71
SEL3224 71
SEL3320 74
SEL3321 74
SEL3322 74
SEL3323 74
SEL3324 74
SEL3425 71
SEL3426 71
SEL3427 71
SEL3428 71
SEL3429 71
SEL3430 71
SEL3431 71
SEL3432 71
SEL3433 71
SEL3434 71
SEL3436 71
SEL3437 72
SEL3438 71
SEL3441 71
SEL3447 71
SEL3451 71
SEL3452 71
SEL3453 71
SEL712006 .. 60
SEL712008 .. 60
SEL712010 .. 60
SEL712012 .. 60
SELGO101 61
SELXP102 . 61
SELXP104 . 61
SELXP106 . 61
SELPXV101 . 61
SELRXO101 . 61
SELRXO102 . 61
SGACBEU 101
SGCOBEU ... 102
SHARK150 ... 3
SHARK306 ... 3
SHARK325 ... 3
SHARK506 ... 4
SHARK506WS 4
SHARK516 ... 4
SHARK516Y 4
SHARK525WS 4
SHARK6801A 5
SHARK6801B 5
SHARK6801C 5
SHARK6801D 5
SHARK6802A 5
SHARK6803A 5
SOC10SG 132
SOC15SG 132
SOC20SG 132
SOC30SG 132
SOPC10SG .. 132
SOPC15SG .. 132
SOPC20SG .. 132
SOPC30SG .. 132
Spirado 127
Spiratrek 127
SSCT1 74

S

SSCT2 74
SSCT3 74
SSCT4 74
SSCT5 74
SSCT6 74
SSCT7 74
STT125BEU . 103
STT160BEU . 103
SYS1051 101
SYS1252 101
SYS1603 101
SYS751 101

T

TC57 65
TCGUN 65
TP151920BK 57
TP151920BL 57
TP151920BN 57
TP151920GR 57
TP151920GR1 57
TP151920GY 57
TP151920RD 57
TP151920WT 57
TP151920YL 57
TP155020BK 57
TP155020RD 57
TP155020YL 57
TR06 87
TR08 87
TR10 87
TR10006 68
TR10008 68
TR10010 68
TR10012 68
TR20006 68
TR20008 68
TR20010 68
TR20012 68
TR30006 68
TR30008 68
TR30010 68
TR30012 68

U

U12-C 21
U18-C 21
U24-C 21
U2x18-C 21
U36-C 21
U3x18-C 21
U407 29
U407 R 29
U408 29
U408 Black ... 33
U408 R 29
U408 White .. 33
U409 29
U409 Black ... 33
U409 R 29
U410 29
U410 R 29
U411 29
U411 R 29
U412 29
U412 R 29
U4-C 21
U8-C 21

V

V6H100100 .. 88

V

V6H10060 88
V6H10080 88
V6H2525 88
V6H4025 88
V6H4040 88
V6H4060 88
V6H4080 88
V6H60100 88
V6H60120 88
V6H6025 88
V6H6040 88
V6H6060 88
V6H6080 88
V6H80100 88
V6H80120 88
V6H8025 88
V6H8040 88
V6H8060 88
V6H8080 88
VD16 26
VD16 FLH 27
VD16 LLH 27
VD16 MLH 27
VD16 R 26
VD16 R-2M .. 26
VD16-2M 26
VD20 26
VD20 Black .. 32
VD20 Black-21 32
VD20 FLH 27
VD20 G 26
VD20 LLH 27
VD20 LLHBLA 27
VD20 MLH 27
VD20 R 26
VD20 R-2M .. 26
VD20 White .. 32
VD20 White-21 32
VD20-2M 26
VD20HFPP .. 28
VD20HFPPMC 28
VD25 26
VD25 LH 27
VD25 LLH 27
VD25 R 26
VD25HPPPMC 28
VD32 26
VD32 LH 27
VD32 LLH 27
VD32 R 26
VD40 26
VD40 LH 27
VD40 R 26
VD50 26
VD50 LH 27
VD50 R 26
VD63 LH 27
VS03XLDE ... 2
VS05XLE 2
VS120E 2
VS250E 2
VS500E 2

W

W10 120
W10.1 120
W100 121
W1000 119
W11850200 .. 2
W16 121

Index

W

W25	122
W30	121
W300	122
W400	122
W4-16	119
W50	119
W500	123
W8-28	119
WAB05200 ...	89
WBLI13	121
WBLI28H4 ...	120
WBLI3SOLAR	123
WBLI5	122
WBLI7SOLAR	123
WBLIS428 ...	120

Z

Z10/16/3F	24, 103
Z16/2F	24, 103
Z16/4F	24, 103
ZBFB	91
ZBFG	91
ZBFG-M	91

WWW.GSV.BE

10/2020



#GSV-WEB



#GSV

TERBEKEHOFDREEF 51
2610 WILRIJK

T: 03 326 50 77
F: 03 326 49 23

WWW.GSV.BE
E: OFFICE@GSV.BE

BTW/TVA BE 0427.142.369
HRA/RCA 245.824

GSV

SINDS – DEPUIS 1985

WIJ BEVESTIGEN UW TOEKOMST
UNE ATTACHE POUR VOTRE AVENIR

