

# BEVESTIGINGSMATERIAAL MATERIEL DE FIXATION

CATALOGUS  
CATALOGUE

2021  
01

The logo for G2V, featuring the letters 'G2V' in a bold, black, sans-serif font. The '2' is stylized with a horizontal line through it. To the right of the letters is a graphic element consisting of three overlapping, curved shapes in shades of orange and yellow, resembling a stylized flame or a leaf.

SINDS – DEPUIS 1985

WIJ BEVESTIGEN UW TOEKOMST  
UNE ATTACHE POUR VOTRE AVENIR



# BESCHERMING EN VEILIGHEID PROTECTION ET SECURITE

Hand Protective Foam  
Mousse de protection pour main



BESTELNUMMER N° DE COMMANDE	INHOUD CONTENU	
W11850200	200 ml	1

Data sheets and certificate on [www.gsv.be](http://www.gsv.be)

Hydroalcoholische handgel 72%  
Gel pour mains hydroalcolique 72%



BESTELNUMMER N° DE COMMANDE	Afm. Dim.	INHOUD CONTENU	
VS120E	290 x 195 x 120	120ml	1/24
VS250E	210 x 160 x 185	250ml	1/12
VS500E	245 x 165 x 170	500ml	1/6
VS03XLDE	380 x 300 x 200	3L*1	1/4
VS05XLE	280 x 200 x 295	5L*2	1/2

\*1 Met pomp / avec pompe

\*2 Voor navulling / recharge

(EC) No 1272/2008

Ready-to-use

Varwacht / Attendu le 01/07/2020



Optische rookmelder - Mini Formaat  
Détecteur de fumée Optique - Mini Format



BESTELNUMMER N° DE COMMANDE	Specificiteit Spécificités	Afm. Dim.
MF001	*1	ø 50 mm x 43 mm
MF002	*2	ø 50 mm x 43 mm

85dB

EN14604:2005 ; + AC:2008

CE conform

\*1 Vervangbare CR2 batterij ; 5 jaar

Batterie CR2 remplaçable ; 5 ans

\*2 Niet vervangbare CR123A/CR17335 batterij ; 10 jaar

Batterie CR123A/CR17335 incluse non-remplaçable ; 10 ans

## GEL/HARS GEL/RESINE

GEL - Twee componenten

GEL - Bi composant



BESTELNUMMER N° DE COMMANDE	INHOUD CONTENU
MP0100	1 L (2 X 0,5 L.)
MP0030	300 ml
MP2200	2 L
MP1000	10 L

GEL - Eén component - Cartridge

GEL - Mono composant - Cartouche



BESTELNUMMER N° DE COMMANDE	INHOUD CONTENU
MPONE GEL	300 ml (Injecteerbaar / Injectable)

Polyurethaan hars - Twee componenten

Résine polyuréthane - Bi composant



BESTELNUMMER N° DE COMMANDE	INHOUD CONTENU
RS150	0,110 L
RS300	0,220 L
RS400	0,290 L
RS550	0,400 l
RS650	0,470 L
RS1650	1,200 L

Met veiligheids vulsysteem  
Avec système de remplissage sécurisé

SHARK - Rechte koppelingen gevuld met gel - met connector

SHARK - Joints pré-remplis en gel - avec connexion



BESTELNUMMER N° DE COMMANDE	∅	Afm. Dim.	Polen Poles
SHARK150	*	86x47 mm	1
SHARK325	1,5 - 2,5 mm <sup>2</sup>	86x47 mm	3
SHARK306	1,5 - 6 mm <sup>2</sup>	145x50 mm	3

\*6 à 25 mm<sup>2</sup> : voor harde draad  
35mm<sup>2</sup> : voor flexibele draad  
\*6 à 25 mm<sup>2</sup> : pour câble rigide  
35mm<sup>2</sup> : pour câble souple

## GEL/HARS GEL/RESINE

SHARK - Rechte koppelingen gevuld met gel - met connector

SHARK - Joints pré-remplis en gel - avec connexion



BESTELNUMMER N° DE COMMANDE	∅	Afm. Dim.	Polen Poles
<b>SHARK516</b>	6 - 16 mm <sup>2</sup>	180x69 mm	5
<b>SHARK506</b>	1,5 - 6 mm <sup>2</sup>	146x50 mm	5

\*6 à 25 mm<sup>2</sup> : voor harde draad

35mm<sup>2</sup> : voor flexibele draad

\*6 à 25 mm<sup>2</sup> : pour câble rigide

35mm<sup>2</sup> : pour câble souple

Y Koppeling gevuld met Gel Met Connector

Joint en Y pré-rempli en Gel avec Connexion



BESTELNUMMER N° DE COMMANDE	∅	Afm. Dim.	Polen Poles
<b>SHARK516Y</b>	6 - 16 mm <sup>2</sup>	220 x 110 mm	5

\*6 - 16 mm<sup>2</sup>

SHARK - Rechte koppelingen gevuld met gel

SHARK - Joints pré-remplis en gel



BESTELNUMMER N° DE COMMANDE	∅	Afm. Dim.	Polen Poles
<b>SHARK506WS</b>	6 - 16 mm <sup>2</sup>	180x69 mm	5
<b>SHARK525WS</b>	6 - 25 mm <sup>2</sup>	240x75 mm	5

Met connector & trekontlasting

Avec connexion & serre-câble

## GEL/HARS GEL/RESINE

SHARK68 - Rechte koppelingen IP68

SHARK68 - Joints IP68



BESTELNUMMER N° DE COMMANDE	∅	Polen Poles
SHARK6801A	6 - 50 mm <sup>2</sup>	1
SHARK6801B	1,5 - 6 mm <sup>2</sup>	3
SHARK6801C	1,5 - 6 mm <sup>2</sup>	3
SHARK6801D	2,5 - 6 mm <sup>2</sup>	4
SHARK6802A	2,5 - 10 mm <sup>2</sup>	5
SHARK6803A	10 - 25 mm <sup>2</sup>	5

IP 68



Koppeling gevuld met Gel - IP68 - Voor Tuinspot

Jonction IP68 pré-remplie de Gel pour Spot Led encastrable



BESTELNUMMER N° DE COMMANDE	∅	Afm. Dim.	
LDJ01	0,5 - 1,5 mm <sup>2</sup>	118x25 mm	1

IP68, 450V, 24A; EN60529

**LEJOY**  
SMART CONNECTION

Met gel gevulde Mini Box

pré-rempli de gel Mini Box



BESTELNUMMER N° DE COMMANDE	∅	Afm. Dim.	
MJB112	0,2 - 4 mm <sup>2</sup>	33x26x2 mm	2/12
MJB113	0,2 - 4 mm <sup>2</sup>	33x26x2 mm	2/12
MJB215	0,2 - 4 mm <sup>2</sup>	33x34x23 mm	1/12
MJB222	0,2 - 4 mm <sup>2</sup>	33x34x23 mm	1/12
MJB332	0,2 - 4 mm <sup>2</sup>	33x46x23 mm	1/12

IPX8, CE, EN 60947-7-1, EN 60998-2-2, 600V, 32A

## Vorstwerend Snoer Cable anti-gel



BESTELNUMMER N° DE COMMANDE	∅	Afm. Dim.	
<b>EASY02</b>	0,2 - 4 mm <sup>2</sup>	2 m	1
<b>EASY04</b>	0,2 - 4 mm <sup>2</sup>	4 m	1
<b>EASY08</b>	0,2 - 4 mm <sup>2</sup>	6 m	1
<b>EASY12</b>	0,2 - 4 mm <sup>2</sup>	12 m	1
<b>EASY18</b>	0,2 - 4 mm <sup>2</sup>	18 m	1

Incl. Thermost. IPX7, 230V

## ZELFREGULERENDE VERWARMINGSKABEL CÂBLE CHAUFFANT AUTO REGULANT



BESTELNUMMER N° DE COMMANDE	Specifici Spécifici	∅	Afm. Dim.	Spanning Tension	
<b>HTC18S</b>	-20°C > +10°C	0,55 mm <sup>2</sup>	8 × 5 mm	230 V AC	1

## ISOLERENDE BUIS UITLAAT KIT KIT POUR SORTIE TUBE ISOLANT

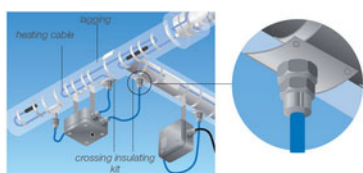

BESTELNUMMER N° DE COMMANDE	Specificiteit Spécificités	
<b>KCP00S</b>	Series S	1

## KIT CONNECTIE EN EINDSTUK KIT CONNECTION ET EMBOUT

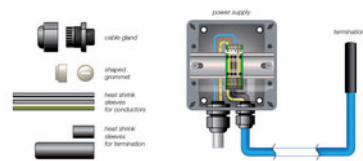

BESTELNUMMER N° DE COMMANDE	Specificiteit Spécificités	
<b>KTA00S</b>	Series S	1

## PVC - LSOH PVC - LSOH

Kabeldozen met uitbrekbare ingangen voor wartels

Boîtes de dérivation avec entrées pré-imprimées



BESTELNUMMER N° DE COMMANDE	Ingangen Entrées	ø	Afm. Dim.	
<b>220A</b>	7	PG 16	80x80x50	10
<b>220AM</b>	7	20 mm	80x80x50	10

220A : Pg-maten / Mesures Pg

220AM : Metrische maten / Mesures métriques

IP 54 Druksluiting / Serrage à pression



Kabeldozen met uitbrekbare ingangen

Boîtes de dérivation avec entrées pré-imprimées



BESTELNUMMER N° DE COMMANDE	Ingangen Entrées	ø	Afm. Dim.	
<b>222A</b>	6	PG 16	100x100x55	5
<b>223A</b>	10	PG 16	175x110x66	2
<b>223ATA</b>	10	PG 16	175x110x83	2
<b>224A</b>	10	PG 29	220x170x120	1
<b>222AM</b>	6	20 mm	100x100x55	5
<b>223AM</b>	10	20 mm	175x110x66	2
<b>223ATAM</b>	10	20 mm	175x110x83	2
<b>224AM</b>	10	25 mm	220x170x120	1

222A à 224A : Pg-maten / Mesures Pg

222AM à 224AM : Metrische maten / Mesures métriques

Schroefsluiting / Serrage à vis 3/4"

IP 65



BOX LINE Kabeldoos met metrische schroefingangen

BOX LINE Boîte de dérivation avec filetage métrique

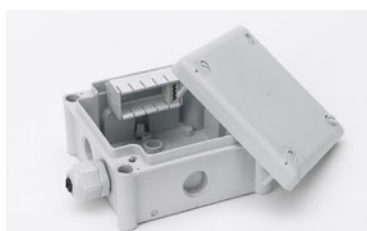

BESTELNUMMER N° DE COMMANDE	Ingangen Entrées	ø	Afm. Dim.	
<b>J100S</b>	7	M20	102 <sup>2</sup> x56 mm	90
<b>J100S CONNECTOR</b>	7	M20	102 <sup>2</sup> x56 mm	90

inclusief connector 3-fasen+n+t

inclus barrette 3-phases+n+t

IP 66





## PVC - LSOH PVC - LSOH

BOX LINE Kabeldozen met nippel

BOX LINE Boîtes de dérivation avec entrées étanches



BESTELNUMMER N° DE COMMANDE	Ingangen Entrées	ø	Afm. Dim.	
<b>J80B</b>	8	M25	83 <sup>2</sup> x50mm	1
<b>J100B</b>	8	M25	102 <sup>2</sup> x56mm	1
<b>J160B</b>	8	M25	116 <sup>2</sup> x70mm	1
<b>J200B</b>	8	M32	216x166x90m	1

IP 66



BOX LINE Kabeldozen gesloten

BOX LINE Boîtes de dérivation fermée



BESTELNUMMER N° DE COMMANDE	Ingangen Entrées	ø	Afm. Dim.	
<b>J80L</b>	8	M25	83 x 83 x 50 mm	1
<b>J100L</b>	8	M25	102 x 102 x 56mm	1
<b>J160L</b>	8	M25	166 x 116 x 70 mm	1
<b>J200L</b>	8	M32	216x166x90m	1

IP 66



Kabeldozen met nippels

Boîtes de dérivation avec entrées étanches



BESTELNUMMER N° DE COMMANDE	Ingangen Entrées	ø	Afm. Dim.	
<b>219B</b>	4*	Pg21	45 x ø80 mm	10
<b>220B</b>	7*	20mm	80 x 80 x 50 mm	10
<b>222B</b>	6**	Pg21	100 x 100 x 55 mm	5
<b>223B</b>	10**	Pg21	175 x 110 x 66 mm	2
<b>223BTA</b>	10**	Pg21	175 x 110 x 83 mm	2
<b>224B</b>	10**	Pg29	220 x 170 x 120 mm	1
<b>226B</b>	10**	Pg29	220 x 170 x 120 mm	1

\*Druksluiting / Serrage à pression

\*\*Schroefsluiting 3/4" / Serrage à vis 3/4"

IP 54



## Toebehoren Accessoires

Nippels

Embouts à gradin



BESTELNUMMER N° DE COMMANDE	Afm. Dim.	
<b>MIB16</b>	3,5-20 mm	50
<b>MIB21</b>	3,5-23,5 mm	50
<b>MIB29</b>	3,5-32 mm	50



## Groot formaat Grands formats

Kabeldozen gesloten

Boîtes de dérivation fermées



BESTELNUMMER N° DE COMMANDE	Afm. Dim.
<b>MF242</b>	322x275x185



Kabeldozen volledig gesloten met transparant deksel

Boîtes de dérivation fermées avec couvercle transparente



BESTELNUMMER N° DE COMMANDE	Afm. Dim.
<b>223LTATR</b>	175x110x83
<b>224LTR</b>	220x170x120

Schroefsluiting 3/4" / Serrage à vis 3/4"



Kabeldozen PH-4A.1

Boîtes de dérivation IP65



BESTELNUMMER N° DE COMMANDE	Normes	Afm. Dim.	
<b>28.41</b>	IP65	248x198x96	1
<b>28.51</b>	IP65	348x228x142	1
<b>28.61</b>	IP65	400x262x140	1



Kabeldozen met nippels PH-4A.3

Boîtes de dérivation avec entrées étanches PH-4A.3

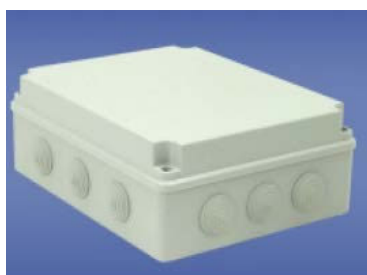

BESTELNUMMER N° DE COMMANDE	Specificiteit Spécificités	Normes	Afm. Dim.	
<b>28.43</b>		IP65	248x198x96	1
<b>28.43-PLEXI</b>	*4		*248x198x96	1

\*Met Plexi deksel - Op aanvraag

\* Avec couvercle en Plexi - sur demande



## Groot formaat Grands formats

Kabeldozen met nippels PH-5A.3

Boîtes de dérivation avec entrées étanches PH-5A.3



BESTELNUMMER N° DE COMMANDE	Normes	Afm. Dim.	
28.53	IP65	348x228x142	1



# Thermoplastisch Thermoplastique

Kabeldozen

Boîtes de dérivation



BESTELNUMMER N° DE COMMANDE	Ingangen Entrées	∅	Afm. Dim.	
FE25	10	1,5-4mm	89x43x37	10/150
FE7	7	1,5-4mm	75x75x37	10/300
FE12	12	1,5-4mm	85x85x37	10/150
FE15	12	1,5-4mm	100x100x37	10/128



## Met soupele ingang Avec membrane

Ronde Kabeldoos met soupele ingang  
Boîte ronde de dérivation avec membrane



BESTELNUMMER N° DE COMMANDE	Afm. Dim.	
M001CS	ø 65x40 mm	1
M002CS	ø 80x40 mm	1



Kabeldoos met soupele ingang  
Boîte de dérivation avec membrane



BESTELNUMMER N° DE COMMANDE	Afm. Dim.	
M003CS	80x80x40 mm	1
M005CS	100x100x40 mm	1



## Brandwerende E90 Anti Feu E90

Brandwerende dozen E90 connectors incl.  
Boîtes Anti Feu E90 connecteurs incl.



BESTELNUMMER N° DE COMMANDE	Ingangen Entrées	ø	Afm. Dim.	
J100BF	7*	M25	102x102x56	1
J100SF	6+1*	M20+M25	102x102x56	1
J160BF	10	M25	166x116x70	1
J200BF	10	M32	216x166x90	1

\*Schroefingangen

\*Entrées filetées

IP66 - Volgens - Selon DIN 4102-12 - Kema EN 60670-22

Keramische connector in steatiet inclusief

Connecteur ceramique en stéatite inclus



Wartel E90  
Presse-étoupe E90



BESTELNUMMER N° DE COMMANDE	Normes	Afm. Dim.	
BM20LA	IP68	20 mm	50
BM25LA	IP68	25 mm	20



Keramische connector in steatiet  
Connecteur ceramique en stéatite



BESTELNUMMER N° DE COMMANDE	Normes	ø	Afm. Dim.	
J402	VDE	1,5-6mm <sup>2</sup>	20X18X15 mm	1
J1602	VDE	1,5-10mm <sup>2</sup>	25x23x21 mm	1
J2021	VDE	1,5-16mm <sup>2</sup>	33x30x23 mm	1

Voor stijve en flexibele draad / Pour fil rigide et flexible

VDE gekeurd - certifiés VDE



Metalen dozen  
Boîtes métalliques



BESTELNUMMER N° DE COMMANDE	Afm. Dim.	
040CDTM254	90x90x47	1
040CDTM255	110x110x51	1
040CDTM256	130x130x60	1
040CDTM257	150x150x72	1
040CDTM258	200x200x90	1

OP BESTELLING / SUR COMMANDE : INOX



# SNELVERBINDERS CONNECTEURS RAPIDES

Universele steekklemmen  
Raccords universels



BESTELNUMMER N° DE COMMANDE	
SDKF2TR-AN	100 / 2000
SDKF3TR-AN	75 / 1500
SDKF5TR-AN	50 / 1000

Stekklemmen voor harde draad  
Raccords pour fil rigide



BESTELNUMMER N° DE COMMANDE	
SDK3	100 / 1000
SDK5	100 / 2000
SDK8	100 / 1000

Lusterklemmen  
Raccords lustre



BESTELNUMMER N° DE COMMANDE	Ø	
50704	2,5 - 4 mm <sup>2</sup>	10
50706	6 mm <sup>2</sup>	10
50710	10 mm <sup>2</sup>	10
50716	16 mm <sup>2</sup>	10
50725	25 mm <sup>2</sup>	10

24A , 450V, CE, HF, PP  
Wit / Blanc

Klemstenen  
Barrettes de connection



BESTELNUMMER N° DE COMMANDE	Specificiteit Spécificités	
397-5	*1	20
397-3A	*1	20
398-5	*2	20
399-5	*3	10

\*1 Voor / Pour : 220A / 220B / 222A / 222B / 222L

\*2 Voor / Pour : FE25 / FE7 / FE12

\*3 Voor / Pour : BOX LINE

# INBOUWDOZEN BOITES D'ENCASTREMENT

Hollewanddozen  
Boîtiers pour mur creux



BESTELNUMMER N° DE COMMANDE	MOD.	ø	Afm. Dim.	
424	1	68 mm	45 mm	10/280
426	1	68 mm	61 mm	10/240
428	2	68 mm	45 mm	5/130
429	3	68 mm	45 mm	5/90



Hollewanddozen - Harde uitvoering  
Boîtiers pour mur creux - Module rigide PVC



BESTELNUMMER N° DE COMMANDE	MOD.	Afm. Dim.	
KP645L	5	354x70x45mm	20

TOT UITPUTTING VAN DE STOCK / JUSQU'A EPUISEMENT DU STOCK

Hollewanddoos Harde Uitvoering - Winddicht  
Boitier Rigide Pour Mur Creux - Etanche



BESTELNUMMER N° DE COMMANDE	MOD.	Afm. Dim.	
KP64-50LD	1	68x70x50mm	110
KP64-60LD	1	68x70x60mm	84
KP64-50-2LD	2	142x70x50mm	40
KP64-50-3LD	3	213x70x50mm	30
KP64-50-4LD	4	284x70x50mm	25
KP64-50-5LD	5	351x70x50mm	14

Hollewanddoos vuurvast  
Boîtier pour mur creux résistant au feu



BESTELNUMMER N° DE COMMANDE	ø	Afm. Dim.
KPZ-1-PO	68 mm	47 mm

PP (halogen-free, pb-free) + foaming material  
temperature resistance: -5 - +60 °C (activation of foaming material from 200 °C)  
EN 1363-1:2013  
EI 15 - EI 120



## INBOUWDOZEN BOITES D'ENCASTREMENT

Universele inbouwdozen zonder Vijs  
Boîtiers d'encastrement universel sans Vis

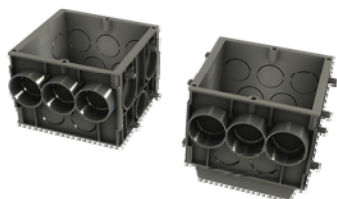

BESTELNUMMER N° DE COMMANDE	MOD.	Afm. Dim.	
430	1	60x60x50mm	10/200
431	1	60x60x65mm	10/200



Universele inbouwdozen met Vijs  
Boîtiers d'encastrement universel avec Vis



BESTELNUMMER N° DE COMMANDE	MOD.	Afm. Dim.	
430V	1	60x60x50mm	10/200
431V	1	60x60x65mm	10/180



Inbouwdozen  
Boîtiers d'encastrement



BESTELNUMMER N° DE COMMANDE	MOD.	Afm. Dim.	
316	1	75x75x42mm	10/100
318	1	75x75x60mm	10/100



## VERDEELKASTEN COFFRETS DE DISTRIBUTION

Verdeelkasten opbouw Type C / IP 40 In-63A

Coffrets de distribution en saillie Type C / IP 40 In-63A



BESTELNUMMER N° DE COMMANDE	MOD.	Afm. Dim.
N4-C	1 x 4	232x139x99 mm
N8-C	1 x 8	215x236x112 mm
N12-C	1 x 12	287x236x112 mm
N18-C	1 x 18	396x236x112 mm
N24-C	2 x 12	287x361x112 mm
N36-C	3 x 12	287x485x112 mm
N2x18-C	2 x 18	396x361x112 mm
N3x18-C	3 x 18	396x526x112 mm
N48-C	4 x 12	287x651x112 mm
N4x18-C	4 x 18	651x396x112 mm

Din rail en aardingsrail inclusief en geïnstalleerd  
Rail Din et barrette de terre pré-installé



Verdeelkasten inbouw Type C / IP 40 In-63A

Coffrets de distribution à encastrer Type C / IP 40 In-63A



BESTELNUMMER N° DE COMMANDE	MOD.	Afm. Dim.
U8-C	1 x 8	211x232x99 mm
U12-C	1 x 12	283x232x106 mm
U18-C	1x 18	392x232x106 mm
U24-C	2 x 12	283x357x106 mm
U36-C	3 x 12	283x482x106 mm
U2x18-C	2 x 18	392x357x106 mm
U3x18-C	3 x 18	392x522x106 mm
U4-C	1 x 4	211 x 232 x 99 mm

Din rail en aardingsrail inclusief en geïnstalleerd  
Rail Din et barrette de terre pré-installé



Verdeelkasten opbouw Type D / IP 65 In-63A

Coffrets de distribution en saillie Type D / IP 65 In-63A



BESTELNUMMER N° DE COMMANDE	MOD.	Afm. Dim.
N8-D	1 x 8	200x200x120 mm
N4-D	1 x 4	127x200x120 mm

Din rail en aardingsrail inclusief en geïnstalleerd  
Rail Din et barrette de terre pré-installé



## VERDEELKASTEN COFFRETS DE DISTRIBUTION

Verdeelkasten opbouw Type D / IP 65 In-63A

Coffrets de distribution en saillie Type D / IP 65 In-63A



BESTELNUMMER N° DE COMMANDE	MOD.	Afm. Dim.
<b>N12-D</b>	1 x 12	318x258x142 mm
<b>N36-D</b>	3 x 12	318x507x142 mm
<b>N24-D</b>	2 x 12	318x383x142 mm

Din rail en aardingsrail inclusief en geïnstalleerd  
Rail Din et barrette de terre pré-installé



Verdeelkasten opbouw Type NEO / IP 65 In-100A

Coffrets de distribution en saillie Type NEO / IP 65 In-100A



BESTELNUMMER N° DE COMMANDE	MOD.	Afm. Dim.
<b>RH18S</b>	1 x 18	435x260x138 mm
<b>RH36/2S</b>	2 x 18	435x420x138 mm
<b>RH54/3S</b>	3 x 18	435x580x138 mm
<b>RH72/4S</b>	4 x 18	435x780x138 mm



Verdeelkasten opbouw IP 55 Incl. din rail

Coffrets de distribution en saillie IP 55



BESTELNUMMER N° DE COMMANDE	Ingangen Entrées	MOD.	Afm. Dim.
<b>250-5AM</b>	6xM20+4xM25	4 + 1	95x162x122 mm
<b>250-9AM</b>	6xM20+4xM25	8 + 1	98x162x202 mm
<b>250-11AM</b>	10xM25	10 + 1	109x232x182 mm
<b>250-9B</b>	10 x PG21 met Nippels	8+1	98 X 162 X 202 mm



Afdekplaatjes voor MCB - Wit - 12 modulen

Couvercles universels pour MCB - Blanc - 12 modules



BESTELNUMMER N° DE COMMANDE	Afm. Dim.	
<b>273MF</b>	200x52x8 mm	10



## VERDEELKASTEN COFFRETS DE DISTRIBUTION

Stopcontact voor borden - DIN Rail 35 mm

Prise de courant pour tableau - DIN Rail 35mm



BESTELNUMMER N° DE COMMANDE	A	Spanning Tension	
C500	16A	230V	1/5

VDE -EN 50 0 22



Kabeldoorvoer Quickseal M32

Cable transit Quickseal M32



BESTELNUMMER N° DE COMMANDE	Afm. Dim.	
TPQSM32	M32	10/100

## KAMGELEIDERS BARRE DE PONTAGE

Kamgeleiders met vork  
Barre de Pontage avec fourche

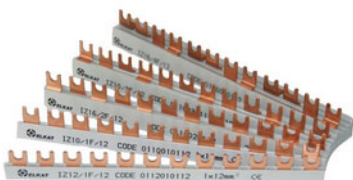

BESTELNUMMER N° DE COMMANDE	MOD.	FASES PHASES	∅	
<b>IZ10/2F/54</b>	54	L1,L2/N	10mm	20
<b>IZ10/3F/54</b>	54	L1,L2,L3	10mm	20
<b>IZ16/2F/54</b>	54	L1,L2/N	16mm	10
<b>IZ16/3F/54</b>	54	L1,L2,L3	16mm	20
<b>IZ16/4F/56</b>	56	L1,L2,L3,N	16mm	10

Lengte / Longueur: 1m

Kamgeleiders met pin  
Barre de Pontage avec broche



BESTELNUMMER N° DE COMMANDE	MOD.	FASES PHASES	∅	
<b>IZS10/3F/54</b>	54	L1,L2,L3	10mm	20
<b>IZS16/2F/54</b>	54	L1,L2/N	16mm	10
<b>IZS16/3F/54</b>	54	L1,L2,L3	16mm	20
<b>IZS16/4F/56</b>	56	L1,L2,L3,N	16mm	10

Lengte / Longueur: 1m

Eindstuk  
Embout



BESTELNUMMER N° DE COMMANDE	∅	
<b>Z103F</b>		
<b>Z162F</b>	16 mm <sup>2</sup>	10/250
<b>Z163F</b>		
<b>Z164F</b>	16 mm <sup>2</sup>	10/250

## VLOERDOZEN BOÏTE POUR SOL

Vloerdozen voor toebehoren 45 x 45

Boîtes sol pour accessoires 45 x 45



BESTELNUMMER N° DE COMMANDE	MOD.	Afm. Dim.
745-4C LG	4	146x250x56 mm
745-8C LG	8	250x250x56 mm
745-CRF748	4 - 8	*

\* Inlegstuk Voor Beton Voor Vloerdozen 4 En 8 Modules

\* Piece d'Encastrement Pour Beton Pour Les Boites Sol 4 Et 8 Modules



Kader voor vloerdoos voor gebruik in beton / chape

Cadre pour boîte sol pour chape de béton



BESTELNUMMER N° DE COMMANDE
CFR748

Polystyreen blok voor vloerdoos

Bloc Polystyrène pour boîte sol

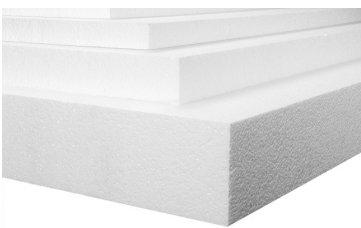

BESTELNUMMER N° DE COMMANDE	MOD.
745-EPS4M	4
745-EPS8M	8

Dubbele afdekplaat + 2 stekkers RJ45 CAT 6

Plaque double + 2 connecteurs RJ45 CAT6



BESTELNUMMER N° DE COMMANDE	Specificiteit Spécificités
745-LAN	CAT 6





# PVC BUIZEN EN TOEBEHOREN TUBES PVC ET ACCESSOIRES

Rechte buizen  
Tubes rigides



BESTELNUMMER N° DE COMMANDE	ø IN	Lengte Longueur	
<b>VD16-2M</b>	16 mm	2 m	30/4050 m
<b>VD20-2M</b>	20 mm	2 m	30/4050 m
<b>VD16</b>	16 mm	3 m	111/5550 m
<b>VD20</b>	20 mm	3 m	111/5550 m
<b>VD25</b>	25 mm	3 m	111/5130 m
<b>VD32</b>	32 mm	3 m	57 m
<b>VD40</b>	40 mm	3 m	30 m
<b>VD50</b>	50 mm	3 m	15 m

Light Grey = RAL 7035

Rechte buizen  
Tubes rigides



BESTELNUMMER N° DE COMMANDE	ø IN	Lengte Longueur	
<b>VD16R-1.5M</b>	16 mm	1,5 m	56 m
<b>VD16 R-2M</b>	16 mm	2 m	30/4050 m
<b>VD20R-1.5</b>	20 mm	1,5 m	56 m
<b>VD20 R-2M</b>	20 mm	2 m	30/4050 m
<b>VD16 R</b>	16 mm	3 m	111/5550 m
<b>VD20 R</b>	20 mm	3 m	111/5550 m
<b>VD25R-1.5M</b>	25 mm	1,5 m	29 m
<b>VD25 R</b>	25 mm	3 m	111/5130 m
<b>VD32R-1.5M</b>	32 mm	1,5 m	29 m
<b>VD32 R</b>	32 mm	3 m	57 m
<b>VD40 R</b>	40 mm	3 m	30 m
<b>VD50 R</b>	50 mm	3 m	15 m
<b>VD63R</b>	63 mm		15 m

R = Dark Grey = RAL 7037

Rechte buizen met mof  
Tubes rigides tulipés



BESTELNUMMER N° DE COMMANDE	ø	
<b>VD20 G</b>	20 mm	111 m / 5.550 m

Lengte / Longueur: 3m  
Light Grey = RAL 7035

# PVC BUIZEN EN TOEBEHOREN TUBES PVC ET ACCESSOIRES

Buizen HALOGEN FREE- PC  
Tubes HALOGEN FREE - PC



BESTELNUMMER N° DE COMMANDE	∅	
<b>VD16 LLH</b>	16 mm	111/5550 m
<b>VD20 LLH</b>	20 mm	111/5550 m
<b>VD20 LLHBLACK</b>	20 mm*	111/5550 m
<b>VD25 LLH</b>	25 mm	57/5130 m
<b>VD32 LLH</b>	32 mm	57 /4275 m

Light Load (2442) : LLH  
Lengte / Longueur: 3m  
RAL 7035 / \*Black RAL 9004  
PC = polycarbonaat/polycarbonate



Buizen HALOGEN FREE - PC  
Tubes HALOGEN FREE - PC



BESTELNUMMER N° DE COMMANDE	∅	
<b>VD16 MLH</b>	16 mm	111/5550 m
<b>VD20 MLH</b>	20 mm	111/5550 m

Medium Load (3442) : MLH

Lengte / Longueur: 3m  
RAL 7035  
PC = polycarbonaat/polycarbonate



Buizen HALOGEN FREE - PC  
Tubes HALOGEN FREE - PC



BESTELNUMMER N° DE COMMANDE	∅	
<b>VD16 FLH</b>	16 mm	111/5550 m
<b>VD20 FLH</b>	20 mm	111/5550 m
<b>VD25 LH</b>	25 mm	57/5130 m
<b>VD32 LH</b>	32 mm	57/4275 m
<b>VD40 LH</b>	40 mm	30 m
<b>VD50 LH</b>	50 mm	15 m
<b>VD63 LH</b>	63 mm	3 m

Heavy Load (4442) : FLH/LH  
Lengte / Longueur: 3m  
RAL 7035  
PC = polycarbonaat/polycarbonate



# PVC BUIZEN EN TOEBEHOREN TUBES PVC ET ACCESSOIRES

Buizen HALOGEN FREE - PP

Tubes HALOGEN FREE - PP



BESTELNUMMER N° DE COMMANDE	∅	
<b>VD20HFPP</b>	20 mm	105 m

Light Grey = RAL 7035

PP= polypropylène/polypropyleen



Buizen HALOGEN FREE PP met manchet

Tubes HALOGEN FREE PP avec manchon



BESTELNUMMER N° DE COMMANDE	∅	
<b>VD20HFPPMOF</b>	20 mm	102/5100 m
<b>VD25HPPPMOF</b>	25 mm	75/3750 m

Light Grey = RAL 7035

PP= polypropylène/polypropyleen



Buis halfzacht, met trekdraad

Tube semi rigide, avec tire-fil



BESTELNUMMER N° DE COMMANDE	∅	
<b>ERFE20G</b>	20 mm	100 m
<b>ERFE25G</b>	25 mm	50 m



Ribbenbuis

Flex



BESTELNUMMER N° DE COMMANDE	∅	
<b>ECICTA20HFT</b>	20 mm	100 m
<b>ECICTA25HFT</b>	25 mm	50 m
<b>ECICTA20HF</b>	20 mm*	100 m
<b>ECICTA25HF</b>	25 mm*	50 m



## PVC BUIZEN EN TOEBEHOREN TUBES PVC ET ACCESSOIRES

Moffen voor rechte PVC buis

Manchons pour conduite rigide en PVC



BESTELNUMMER N° DE COMMANDE	∅	RAL	
U407	16 mm	RAL 7035	100/2500
U408	20 mm	RAL 7035	100/1600
U409	25 mm	RAL 7035	25/1150
U410	32 mm	RAL 7035	25/600
U411	40 mm	RAL 7035	25
U412	50 mm	RAL 7035	5
U407 R	16 mm	RAL 7037	100/2500
U408 R	20 mm	RAL 7037	100/1600
U409 R	25 mm	RAL 7037	25/1150
U410 R	32 mm	RAL 7037	25/600
U411 R	40 mm	RAL 7037	25
U412 R	50 mm	RAL 7037	5
U413R	63 mm	RAL 7037	5

Light Grey = RAL 7035

R = Dark Grey = RAL 7037



Bochten 90° voor rechte PVC buis

Coudes 90° pour conduite rigide en PVC



BESTELNUMMER N° DE COMMANDE	∅	RAL	
C16VD	16 mm	RAL 7035	50
C20VD	20 mm	RAL 7035	50
C25VD	25 mm	RAL 7035	5
C32VD	32 mm	RAL 7035	5
C40VD	40 mm	RAL 7035	5
C50VD	50 mm	RAL 7035	3
C16VD R	16 mm	RAL 7037	50
C20VD R	20 mm	RAL 7037	50
C25VD R	25 mm	RAL 7037	5
C32VD R	32 mm	RAL 7037	5
C40VD R	40 mm	RAL 7037	5
C50VD R	50 mm	RAL 7037	3

Light Grey = RAL 7035

R = Dark Grey = RAL 7037



## PVC BUIZEN EN TOEBEHOREN TUBES PVC ET ACCESSOIRES

Eindtullen voor rechte PVC buis

Embouts pour conduite rigide en PVC



BESTELNUMMER N° DE COMMANDE	∅	RAL	
<b>EC16</b>	16 mm	RAL 7035	100/7000
<b>EC20</b>	20 mm	RAL 7035	100/5500
<b>EC25</b>	25 mm	RAL 7035	50/2500
<b>EC16 R</b>	16 mm	RAL 7037	100/7000
<b>EC20 R</b>	20 mm	RAL 7037	100/5500
<b>EC25 R</b>	25 mm	RAL 7037	50/2500

Light Grey = RAL 7035

R = Dark Grey = RAL 7037



Invoertule M20

Entrées tube M20



BESTELNUMMER N° DE COMMANDE	∅	
<b>MIBR1620</b>	16 & 20 mm	50/2000

Light Grey = RAL 7035



## METALEN BUIZEN TUBE EN METAL

Metalen buizen, zonder schroefdraad - Galvanisch verzinkt

Tubes en métal, sans filetage - Galvanisé



BESTELNUMMER N° DE COMMANDE	Afm. Dim.	
010TARM016	M16 x 1,5	3 m/51 m
010TARM020	M20 x 1,5	3 m/30 m
010TARM025	M25 x 1,5	3 m/30 m
010TARM032	M32 x 1,5	3 m/21 m
010TARM040	M40 x 1,5	3 m/15 m
010TARM050	M50 x 1,5	3 m/15 m
010TARM063	M63 x 1,5	3 m/9 m

Conform EN 61386 21 - code 5557

OP BESTELLING / SUR COMMANDE : INOX

Buis Zonder Schroefdraad - Rvs Aisi 304

Tubes INOX sans filetage



BESTELNUMMER N° DE COMMANDE	Afm. Dim.	
060TARMI20	M20	3 m - 30 m
060TARMI25	M25	3 m - 30 m
060TARMI32	M32	3 m - 21 m
060TARMI40	M40	3 m - 15 m
060TARMI50	M50	3 m - 15 m

Metalen bochten, zonder schroefdraad - Galvanisch verzinkt

Coudes en métal 90°, sans filetage - Galvanisé



BESTELNUMMER N° DE COMMANDE	∅	
020CARM016	M16	10
020CARM020	M20	10
020CARM025	M25	10
020CARM032	M32	10
020CARM040	M40	5
020CARM050	M50	5
020CARM063	M63	5

Conform EN 61386 21 - code 5557

OP BESTELLING / SUR COMMANDE : INOX

## METALEN BUIZEN TUBE EN METAL

Metalen bochten, zonder schroefdraad - Rvs Aisi 304

Coudes en métal 90°, sans filetage - INOX



BESTELNUMMER N° DE COMMANDE	Afm. Dim.	
061CARM120	M20	5
061CARM125	M25	5
061CARM132	M32	5
061CARM140	M40	5
061CARM150	M50	1

Koppelstukken, zonder schroefdraad - Galvanisch verzinkt

Manchons sans filetage - Galvanisé



BESTELNUMMER N° DE COMMANDE	Ø	
020MARM016	M16 - L45 mm	100
020MARM020	M20 - L50 mm	100
020MARM025	M25 - L55 mm	60
020MARM032	M32 - L65 mm	30
020MARM040	M40 - L70 mm	25
020MARM050	M50 - L90 mm	12
020MARM063	M63 - L105 mm	6

Conform EN 61386 21 - code 5557

OP BESTELLING / SUR COMMANDE : INOX

Koppelstukken, zonder schroefdraad - Rvs Aisi 304

Manchons sans filetage - INOX



BESTELNUMMER N° DE COMMANDE	Afm. Dim.	
061MACMI20	M20	12
061MARM125	M25	8
061MACMI32	M32	5
061MACMI40	M40	3
061MACMI50	M50	2

Conform EN 61386 21 - code 5557

OP BESTELLING / SUR COMMANDE : INOX

## BLACK & WHITE BLACK & WHITE

Rechte buis  
Tube rigide



BESTELNUMMER N° DE COMMANDE	Afm. Dim.	
<b>VD20 Black</b>	20 mm	111m
<b>VD20 White</b>	20 mm	111m
<b>VD20 Black-2M</b>	20 mm	30m*
<b>VD20 White-2M</b>	20 mm	30m*
<b>VD20 Black-1.5M</b>		

Lengte / Longueur: 3m

\*Lengte / Longueur: 2m

White = RAL 9003

Black = RAL 9004

Eindstuk  
Embout



BESTELNUMMER N° DE COMMANDE	Afm. Dim.	
<b>EC20 Black</b>	20 mm	100 / 2000
<b>EC20 White</b>	20 mm	100 / 2000

Black = RAL 9004

White = RAL 9003



PVC Stop  
Bouchon PVC



BESTELNUMMER N° DE COMMANDE	Afm. Dim.	
<b>907M20 Black</b>	20 mm	50 / 2000

Black = RAL 9004



Buisinvoer  
Entrée tube



BESTELNUMMER N° DE COMMANDE	Afm. Dim.	
<b>MIBR1620 Black</b>	16/20 mm	50 / 2000
<b>MIBR1620 White</b>	16/20 mm	50 / 2000

White = RAL 9003

Black = RAL 9004





# BLACK & WHITE BLACK & WHITE

Mof  
Manchon



BESTELNUMMER N° DE COMMANDE	Afm. Dim.	
<b>U408 White</b>	20 mm	50 / 1600
<b>U408 Black</b>	20 mm	100 / 1600
<b>U409 Black</b>	25 mm	25

White = RAL 9003  
Black = RAL 9004



Veerklem Black & White  
Attache ressort Black & White



BESTELNUMMER N° DE COMMANDE	Afm. Dim.	
<b>204 White</b>	20 mm	100 / 2000
<b>204 Black</b>	20 mm	100 / 2000
<b>208 Black</b>	25 mm	50 / 1500

White = RAL 9003  
Black = RAL 9004



Aaneenschuifbare drukklemmen  
Attaches à pression à juxtaposer



BESTELNUMMER N° DE COMMANDE	Afm. Dim.	
<b>2036 Black</b>	12 - 20 mm	50 / 1500
<b>2037 Black</b>	16 - 24 mm	50 / 1500

Black = RAL 9004



Nagelclips - Platte Kabel - Wit  
Attaches à clouer - câble plat - Blanc



BESTELNUMMER N° DE COMMANDE	∅	
<b>702-2W</b>	2 x 1,5	100



## BLACK & WHITE BLACK & WHITE

Nagelclips - maten in mm

Attaches à clouer - mesures en mm



BESTELNUMMER N° DE COMMANDE	∅	
<b>3007-18Black</b>	7 mm*	100 / 12800

De 2 laatste cijfers van het bestelnummer duiden de lengte van de nagel aan. Kleur: Grijs  
Les 2 derniers chiffres du n° de commande indiquent la longueur du clou. Couleur: Gris  
\*Zwart / Noire



Wartel

Presse-étoupe



BESTELNUMMER N° DE COMMANDE	Afm. Dim.	
<b>BM20 White</b>	20 mm	50 / 2000
<b>BM20 Black</b>	20 mm	50 / 2000

White = RAL 9003  
Black = RAL 9004



Boxline kabeldoos schroefingangen M20

Boxline boîte de dérivation filetage M20



BESTELNUMMER N° DE COMMANDE	Ingangen Entrées	∅	Afm. Dim.	
<b>J100S Black</b>	7	M20	102x56 mm	1 / 90
<b>J100S White</b>	7	M20	102x56 mm	1 / 90

White = RAL 9003  
Black = RAL 9004



## BLACK & WHITE BLACK & WHITE

Kabeldoos thermoplast

Boîte de dérivation thermoplastique



BESTELNUMMER N° DE COMMANDE	Ingangen Entrées	Afm. Dim.	
<b>FE25 Black</b>		89 x 43 x 37 mm	10 / 150
<b>FE25 White</b>		89 x 43 x 37 mm	10 / 150
<b>FE7 Black</b>	7	75x75x37	10/300

Black = RAL 9004  
White = RAL 9010  
ø 1,5-4mm



Kanalen Inway zwart

Goulotte Inway noir



Voor meer informatie, zie hoofdstuk kanalen vanaf p.107  
Pour plus d'info, cf. chapitre goulottes à partir de p. 107



# WARTELS PRESSE-ETOUPES

Wartels - Pg reeks

Presse-étoupes - Série Pg



BESTELNUMMER N° DE COMMANDE	∅	
90507	PG7	50
90509	PG9	50 / 3750
90511	PG11	50 / 2700
90513	PG13,5	50 / 2700
90516	PG16	50 / 1850
90521	PG21	20 / 1080
90529	PG29	20 / 440
90536	PG36	10 / 220
90548	PG48	5

Polystyrol

Schokbestendig / Résistant au choc

Wurgring in rubber / Bague d'échanchéité en caoutchouc

Drukrondel in gegalvaniseerd ijzer / Rondelle de pression en acier galvanisé

IP 65 – 5°C à + 60°C



Wartels met trekontlasting - Pg reeks

Presse-étoupes à serrage - Série Pg



BESTELNUMMER N° DE COMMANDE	∅	
9707-ORL01	PG7	100
9709-ORL02	PG9	100
9711-ORL03	PG11	100
9713-ORL04	PG13,5	100
9716-ORL05	PG16	50
9721-ORL06	PG21	50
9729-ORL07	PG29	25
9736-ORL08	PG36	10
9748-ORL10	PG48	5

Polyamide met TPE rubber / Bague TPE

IP 68 –30°C à + 80°C



# WARTELS PRESSE-ETOUPES

Tegenmoeren - Pg reeks  
 Contre-écrous - Série Pg



BESTELNUMMER N° DE COMMANDE	Ø	
90607	PG7	50
90609	PG9	50
90611	PG11	50
90613	PG13,5	50 / 5600
90616	PG16	50 / 5600
90621	PG21	20 / 2240
90629	PG29	20 / 2240
90636	PG36	10
90648	PG48	10

Polystyrol / Polystyrene  
 Schokbestendig / Résistant au choc  
 - 5°C à + 60°C  
 DIN 46320 - L



Stoppen - Pg reeks  
 Bouchons - Série Pg



BESTELNUMMER N° DE COMMANDE	Ø	
90707	PG7	100
90709	PG9	100
90711	PG11	100
90713	PG13,5	50
90716	PG16	50
90721	PG21	50
90729	PG29	50
90736	PG36	50
90748	PG48	25

Polystyrol / Polystyrene  
 Schokbestendig / Résistant au choc  
 - 5°C à + 60°C  
 DIN 46320 - N



# WARTELS PRESSE-ETOUPES

Wartels - Metrische reeks

Presse-étoupes - Série Métrique IP54



BESTELNUMMER N° DE COMMANDE	∅	
<b>905M12-DMRL01</b>	12 mm	50
<b>905M16-DMRL03</b>	16 mm	50
<b>905M20-DMRL04</b>	20 mm	100
<b>905M25-DMRL06</b>	25 mm	50

Polyamide / IP 54 / -30°C / +80°C,  
TPV Rubber / Bague TPV, EN60423



Wartels met trekontlasting - Metrische reeks IP68

Presse-étoupes à serrage - Série Métrique IP68



BESTELNUMMER N° DE COMMANDE	∅	
<b>BM12</b>	12 mm	50 / 2000
<b>BM16</b>	16 mm	50 / 2000
<b>BM20</b>	20 mm	50 / 2000
<b>BM25</b>	25 mm	20 / 800
<b>BM32</b>	32 mm	20 / 600
<b>BM40</b>	40 mm	10 / 300
<b>BM50</b>	50 mm	5 / 200
<b>BM63</b>	63 mm	5 / 120

Met skintop en trekontlasting  
Avec skintop et serrage étendu  
Polyamide / IP 68 / -20°C / +125°C



Wartels MULTIHOLE met trekontlasting - Metrische reeks IP65

Presse-étoupes MULTIHOLE à serrage - Série Métrique IP6

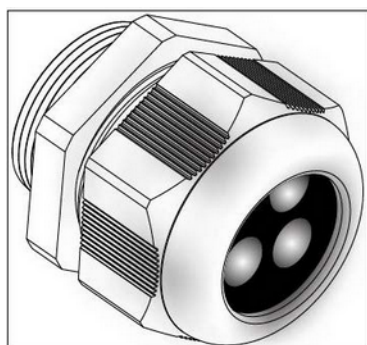

BESTELNUMMER N° DE COMMANDE	∅	RAL
<b>OMRL05A7</b>	M20	RAL7035

IP65, -30°C / +80°C, RAL7035



# WARTELS PRESSE-ETOUPES

Wartels met trekcontlasting

Presse-étoupes à serrage - Série Métrique



BESTELNUMMER N° DE COMMANDE	Ø	
<b>OMRL03 M16</b>	M16 (5-10 mm)	150 / 2500
<b>OMRL05 M20</b>	M20 (10-14 mm)	150 / 2500
<b>OMRL09 M50</b>	M50	100 / 1600
<b>OMRL10 M63</b>	M63	100 / 1600

Polyamide / IP 68  
 -30°C / +80°C,  
 TPV Rubber / Bague TPV, EN50262, RAL7035, VDE  
 RAL7035  
 Einde Reeks/Fin de série



Tegenmoeren - Metrische reeks

Contre-écrous - Série Métrique



BESTELNUMMER N° DE COMMANDE	Ø	
<b>PM12</b>	12 mm	100
<b>PM16</b>	16 mm	50
<b>PM20</b>	20 mm	50 / 5600
<b>PM25</b>	25 mm	20 / 2240
<b>PM32</b>	32 mm	20
<b>PM40</b>	40 mm	20
<b>PM50</b>	50 MM	10
<b>PM63</b>	63 MM	5

Polyamide  
 RAL7035  
 - 20°C / +125°C



Stoppen - Metrische reeks

Bouchons - Série Métrique



BESTELNUMMER N° DE COMMANDE	Ø	
<b>907M12</b>	12 mm	100
<b>907M16</b>	16 mm	100
<b>907M20</b>	20 mm	100
<b>907M25</b>	25 mm	25
<b>907M32</b>	32 mm	20

Polyamide  
 RAL7035  
 - 30°C / +80°C



# WARTELS PRESSE-ETOUPES

Stoppen - Metrische reeks  
Bouchons - Série Métrique



BESTELNUMMER N° DE COMMANDE	∅	
907M40	40 mm	10
907M50	50 mm	4
907M63	63 mm	4

Polyamide  
RAL7035  
- 30°C / +80°C



Wurgnippels - Metrische reeks  
Raccords à visser - Série Métrique



BESTELNUMMER N° DE COMMANDE	∅	
908M16	16 mm	100
908M20	20 mm	100
908M25	25 mm	100
908M32	32 mm	50
908M40	40 mm	25
908M50	50 mm	10

Polyamide  
RAL7035  
- 30°C / +80°C



Drukmoeren - Metrische reeks  
Boulons de pression - Série Métrique



BESTELNUMMER N° DE COMMANDE	∅
909M16	16 mm
909M20	20 mm





# WARTELS PRESSE-ETOUPES

Vergrotingen - Metrische reeks  
Augmentations - Série Métrique



BESTELNUMMER N° DE COMMANDE	ø IN	ø	
<b>ME1216</b>	M16	M12	100
<b>ME1620</b>	M20	M16	100
<b>ME2025</b>	M25	M20	100
<b>ME2532</b>	M32	M25	50
<b>ME3240</b>	M40	M32	50

Polystyrol / IP 65 / - 5°C / + 60°C



Verkleiningen - Metrische reeks  
Réductions - Série Métrique



BESTELNUMMER N° DE COMMANDE	ø IN	ø	
<b>MR1612</b>	M12	M16	100
<b>MR2012</b>	M12	M20	100
<b>MR2016</b>	M16	M20	100
<b>MR2512</b>	M12	M25	100
<b>MR2516</b>	M16	M25	100
<b>MR2520</b>	M20	M25	100
<b>MR3212</b>	M12	M32	50
<b>MR3216</b>	M16	M32	50
<b>MR3220</b>	M20	M32	50
<b>MR3225</b>	M25	M32	50
<b>MR4016</b>	M16	M40	50
<b>MR4020</b>	M20	M40	50
<b>MR4025</b>	M25	M40	50
<b>MR4032</b>	M32	M40	50
<b>MR5020</b>	M20	M50	25
<b>MR5025</b>	M25	M50	25
<b>MR5032</b>	M32	M50	25
<b>MR5040</b>	M40	M50	25
<b>MR6325</b>	M25	M63	25
<b>MR6332</b>	M32	M63	25
<b>MR6340</b>	M40	M63	25
<b>MR6350</b>	M50	M63	25



## WARTELS PRESSE-ETOUPES

Wartels Messing met trekontlasting - Metrische reeks

Pressé-étoupes Laiton nickelé à serrage - Métrique



BESTELNUMMER N° DE COMMANDE	∅	
<b>OMBG01</b>	12 mm	20 / 100
<b>OMBG02</b>	16 mm	20 / 100
<b>OMBG03</b>	20 mm	20 / 100
<b>OMBG04</b>	25 mm	20 / 100
<b>OMBG05</b>	32 mm	10 / 100
<b>OMBG06</b>	40 mm	10 / 100
<b>OMBG07</b>	50 mm	5 / 50
<b>OMBG08</b>	63 mm	1 / 10

Messing / Laiton nickelé

IP 68

-40°C à +100°C, TPV Rubber / Bague TPV

EN60423

Tegenmoeren Messing - Metrische reeks

Contre-écrous Laiton nickelé - Série Métrique



BESTELNUMMER N° DE COMMANDE	∅	
<b>OMBL01</b>	12 mm	20 / 100
<b>OMBL02</b>	16 mm	20 / 100
<b>OMBL03</b>	20 mm	20 / 100
<b>OMBL04</b>	25 mm	20 / 100
<b>OMBL05</b>	32 mm	10 / 100
<b>OMBL06</b>	40 mm	10 / 100
<b>OMBL07</b>	50 mm	5 / 50
<b>OMBL08</b>	63 mm	1 / 10

Messing / Laiton nickelé

EN60423

# KLEMMEN ATTACHES

veerklemmen  
Attaches ressort



BESTELNUMMER N° DE COMMANDE	∅	
108	50 mm	25 / 600

M6 Polyamide  
Kleur : grijs  
Couleur : gris



Aaneenschuifbare veerklemmen  
Attaches ressort à juxtaposer



BESTELNUMMER N° DE COMMANDE	∅	
211	16 mm	100 / 4000
204	20 mm	100 / 3000
208	25 mm	50 / 1500
209	32 mm	50 / 1500
210	40 mm	25 / 750

M6 Polyamide  
Kleur : grijs  
Couleur : gris



Aaneenschuifbare drukklemmen  
Attaches pression à juxtaposer



BESTELNUMMER N° DE COMMANDE	∅	
2035	6 - 13 mm	50 / 3750
2036	12 - 20 mm	50 / 1500
2037	16 - 24 mm	50 / 1500
2038	18 - 30 mm	50 / 1200
2039	27 - 43 mm	25 / 750

M6 Polyamide  
Kleur : grijs  
Couleur : gris



# KLEMMEN ATTACHES

Universele klemmen  
Attaches universelles





BESTELNUMMER N° DE COMMANDE	∅	
<b>031G</b>	16 - 22 mm	50 / 2700
<b>031T</b>	16 - 22 mm	50 / 2700

Kleur : Grijs of transparant  
Couleur : Gris ou transparent

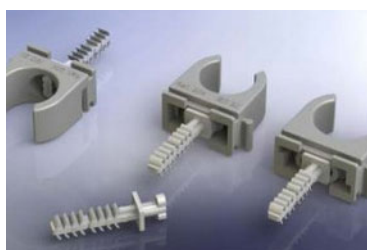

Veerklem met Plug M6  
Attache Ressort avec Cheville M6



BESTELNUMMER N° DE COMMANDE	∅	
<b>204 D</b>	16 mm	50/2000
<b>211 D</b>	20 mm	100/4000

M6 Polyamide  
Kleur : grijs  
Couleur : gris



Drukklem met Plug M6  
Attaches pression avec Cheville M6



BESTELNUMMER N° DE COMMANDE	∅	
<b>2036 D</b>	12 - 20 mm	50 / 1500
<b>2037 D</b>	16 - 24 mm	50 / 1200

M6 Polyamide  
Kleur : grijs  
Couleur : gris



Plug M6 voor veer- en drukklemmen  
Cheville M6 pour attaches ressort et à pression



BESTELNUMMER N° DE COMMANDE	
<b>20436</b>	100

M6 Polyamide  
Kleur : grijs  
Couleur : gris



# KLEMMEN ATTACHES

## Vorkklemmen Attaches fourchette



BESTELNUMMER N° DE COMMANDE	∅	
512	10 mm	100
513	12 mm	100
515	14 - 15 mm	100
516	16 - 18 mm	50/2500
517	20 - 22 mm	50/2500
518	22 - 25 mm	50/2700
519	35 mm	20
520	42 mm	25

M6 Polyamide  
Grijs / gris



## Vorkklemmen dubbel Attaches fourchette double



BESTELNUMMER N° DE COMMANDE	∅	
512-2	10 mm	50
513-2	12 mm	50
515-2	14 - 15 mm	50
516-2	16 - 18 mm	25/1350
517-2	20 - 22 mm	25/1350
518-2	25 - 28 mm	25

Voor gelijktijdige bevestiging van 2 kabels of buizen  
Pour fixation simultane de 2 cables ou tubes  
M6 Polyamide  
Grijs / gris



## KZM kabelzadels KZM attaches



BESTELNUMMER N° DE COMMANDE	∅	
905	5 - 14 mm	100/4000
906	6 - 17 mm	50/2000
907	15 - 25 mm	50/1200
908	24 - 34 mm	25/750

Polypropyleen/Polypropylène  
Vijs in polystyrol/Vis en polystyrol



## KLEMMEN ATTACHES

KZM kabelzadels dubbel  
KZM attaches double



BESTELNUMMER N° DE COMMANDE	∅	
<b>906-2</b>	6 - 17 mm	50/1500

Polypropyleen/Polypropylène  
Vijs in polystyrol/Vis en polystyrol



Saniclips M6  
Saniclips M6



BESTELNUMMER N° DE COMMANDE	∅	
<b>M512</b>	12 mm	100
<b>M515</b>	14/15 mm	100
<b>M518</b>	16/18 mm	100
<b>M522</b>	20/22 mm	100
<b>M512-2</b>	2x12 mm	100
<b>M515-2</b>	2x14/15 mm	100
<b>M518-2</b>	2x16/18 mm	100
<b>M522-2</b>	2x20/22 mm	100



Slagklemmen  
Attaches intercalaires



BESTELNUMMER N° DE COMMANDE	∅	
<b>2047</b>	5 - 25 mm	100 / 5400
<b>2048</b>	8 - 38 mm	100 / 3000

Snelle montage voor rail 761 & 2761  
Fixation rapide pour rail 761 & 2761



# KLEMMEN ATTACHES

## Kabelhouder Attaches câble

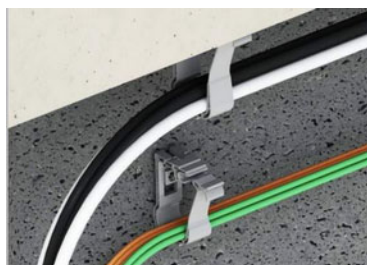

BESTELNUMMER N° DE COMMANDE	Normes	Afm. Dim.
710-15	Max. 10kg	38x69 mm
710-30	Max. 10kg	42x106 mm



## Railklemmen Attaches pour rail avec vis



BESTELNUMMER N° DE COMMANDE	∅	
2050	7 - 25 mm	100 / 5400
2051	13 - 38 mm	100 / 3000

Voor rail 761 & 2761  
Pour rail 761 & 2761



## Aaneenschuifbare 'Clic' klemmen Attaches 'Clic' à juxtaposer



BESTELNUMMER N° DE COMMANDE	∅	
701516	15 - 16 mm	50
701920	20 - 22 mm	50
702225	25 - 28 mm	50
703235	32 - 35 mm	50



## Klembeugels "Marine" Attaches "Marine"



BESTELNUMMER N° DE COMMANDE	∅	
9700012	12 mm	300 / 1200
9700016	16 mm	250 / 1000
9700020	20 mm	200 / 800
9700025	25 mm	150 / 600
9700028	28 mm	125 / 500

Afmetingen / Dimensions : 20 x 1,25 mm  
Gat / Trou : 5 mm

## KLEMMEN ATTACHES

Klembeugels "Speed" Enkel  
Attaches "Speed" Simple



BESTELNUMMER N° DE COMMANDE	∅	
9701016	16 mm	250 / 1000
9701020	20 mm	175 / 700
9701025	25 mm	150 / 600

Schietbeugel  
Attache pour tirer

Klembeugels "Speed" dubbel  
Attaches "Speed" double



BESTELNUMMER N° DE COMMANDE	∅	
9700316	2 x 16 mm	100 / 400
9700320	2 x 20 mm	75 / 300
9700325	2 x 25 mm	50 / 200

Schietbeugel  
Attache pour tirer

IJzeren inslagbeugel  
Attache à frapper en métal



BESTELNUMMER N° DE COMMANDE	∅	
9100900	16 - 20 mm	500 / 2000

IJzeren zadels - rood gelakt  
Attaches en acier - rouge laquée



BESTELNUMMER N° DE COMMANDE	∅	
9100001	16 mm	500 / 2000
9100002	20 mm	350 / 1400
9100004	25 mm	150 / 600
9100005	32 mm	100 / 400
9100026	40 mm	75 / 300
9100007	50 mm	50 / 200
9100029	2 x 16 mm	250 / 1000
9100030	3 x 16 mm	200 / 800



## KLEMMEN ATTACHES

IJzeren zadels - rood gelakt  
 Attaches en acier - rouge laquée



BESTELNUMMER N° DE COMMANDE	∅	
9100031	4 x 16 mm	150 / 600
9100066	2 x 20 mm	200 / 800
9100067	3 x 20 mm	150 / 600

IJzeren zadels - verzinkt  
 Attaches en acier - galvanisé



BESTELNUMMER N° DE COMMANDE	∅	
9100116	16 mm	500 / 2000
9100120	20 mm	350 / 1400
9100126	25 mm	150 / 600
9100132	32 mm	100 / 400
9100140	40 mm	75 / 300
9100150	50 mm	50 / 200
9100037	2 x 16 mm	250 / 1000
9100038	3 x 16 mm	200 / 800
9100707	4 x 16 mm	150 / 600
9100046	2 x 20 mm	200 / 800
9100047	3 x 20 mm	150 / 600

Zadels enkel pad - gegalvaniseerd  
 Attaches simple patte - galvanisé



BESTELNUMMER N° DE COMMANDE	∅	
9700916	16 mm	500 / 2000
9700920	20 mm	350 / 1400
9700925	25 mm	150 / 600

## KLEMMEN ATTACHES

Zadels in U-vorm - rood gelakt

Attaches en forme U - rouge laquée



BESTELNUMMER N° DE COMMANDE	∅	
9100056	16 mm	500 / 2000
9100057	20 mm	350 / 1400
9100903	25 mm	150 / 600

## FUNCTIEBEHOUD MAINTIEN DE FONCTION

FBB beugel, inclusief schroefanker - E90

Attache, cheville à visser incluse - E90



BESTELNUMMER N° DE COMMANDE	Ø	
9700806	6 mm	200 / 800
9700808	8 mm	200 / 800
9700810	10 mm	200 / 800
9700812	12 mm	200 / 800
9700814	14 mm	150 / 600
9700816	16 mm	150 / 600
9700819	19 mm	150 / 600
9700825	25 mm	100 / 400
9702816	16 mm	75/300
9702819	19 mm	75/300
9700850	*1	
9700855	*2	
9700860	*3	
9230460	*4	

Per verpakking een SDS boor (torx bitje) inclusief

\*1 Schroefanker - TSM

\*2 Schroefbit - Torx 25 - 1 /4"

\*3 SDS functiebehoudboor - dia. 5x110

\*4 Duimnagel E30 - E90 - E120

Une mèche SDS (torx) incluse par emballage

\*1 Vis maintien de fonction - TSM

\*2 nr 25 Embout de vissage - Torx 25 - 1/4"

\*3 Mèche SDS - dia. 5x110

\*4 Cheville à Pousser E30 - E90 - E120



FBB beugel, inclusief inslaganker - E90

Attache, cheville à frapper incluse - E90



BESTELNUMMER N° DE COMMANDE	Ø	
9700826	6 mm	200 / 800
9700828	8 mm	200 / 800
9700830	10 mm	200 / 800
9700832	12 mm	200 / 800
9700834	14 mm	150 / 600
9700836	16 mm	150 / 600
9700839	19 mm	150 / 600

\*1 SDS functiebehoudboor - dia. 6x110

\*2 Inslaganker TDN 6/35

\*1 Mèche SDS - dia. 6x110

\*2 Cheville à frapper maintien de fonction TDN 6/35



## FUNCTIEBEHOUD MAINTIEN DE FONCTION

FBB beugel, inclusief inslaganker - E90  
 Attache, cheville à frapper incluse - E90



BESTELNUMMER N° DE COMMANDE	∅	
9700845	25 mm	100 / 400
9702836	16 mm	75/300
9702839	19 mm	75/300
9700880	*2	
9700875	*1	

\*1 SDS functiebehoudboor - dia. 6x110

\*2 Inslaganker TDN 6/35

\*1 Mèche SDS - dia. 6x110

\*2 Cheville à frapper maintien de fonction TDN 6/35



FBB Beugel en Duim Nagel  
 Attache + cheville a Pousser maintien de fonction



BESTELNUMMER N° DE COMMANDE	Omschrijving	Description	∅	
9700817	Enkel	Simple	16 mm	150/ 600
9700820	Enkel	Simple	19 mm	150/ 600
9702817	Dubbel	Double	16 mm	150/ 600
9702820	Dubbel	Double	19 mm	150/ 600



Klem voor buis en kabel met eenzijdige schuifbare sluiting  
 Collier pour câble et tube-fermeture unilatérale coulissant



BESTELNUMMER N° DE COMMANDE	∅	
5605-16	14-18 mm	100
5605-22	19-23 mm	75
5605-28	24-28 mm	50
5605-38	30-38 mm	40
5605-50	39-52 mm	30
5605-60	53-61 mm	20

E90 (volgens/selon DIN 4102-12)

OP BESTELLING / SUR COMMANDE : INOX



## FUNCTIEBEHOUD MAINTIEN DE FONCTION

Verzamelbeugel Cable guide Functiebehoudbevestiging  
Collier pour câbles à maintient de fonction

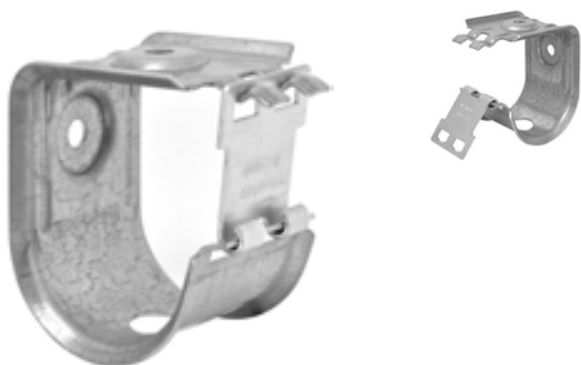

BESTELNUMMER N° DE COMMANDE	Afm. Dim.	
9702845	74x73 mm	1/36

E30-E90



## PROFIELKLEMMEN ATTACHES POUR PROFILES

Clipsen

Clips



BESTELNUMMER N° DE COMMANDE	Oud Ref. Ancienne réf.	Dikte profiel Epaisseur profile	
FH4-DT	SI100DT	1,5 - 4 mm	100
FH10-DT	SI101DT	4 - 10 mm	100
FH15-DT	SI102DT	10 - 15 mm	100
FH20-DT	SI103DT	15 - 20 mm	100

Voor draadstang

Pour tiges filetées



BESTELNUMMER N° DE COMMANDE	Oud Ref. Ancienne réf.	Dikte profiel Epaisseur profile	
FH20-ICA10DT	SI103-212DT	15 - 20 mm / M10	100
FH15-ICA10DT	SI102-212DT	10 - 15 mm / M10	100
FH4-ICA8DT	SI100-211DT	1,5 - 4 mm / M8	100
FH15-ICA8DT	SI102-211DT	10 - 15 mm / M8	100
FH20-ICA6DT	SI103-210DT	15 - 20 mm / M6	100
FH20-ICA8DT	SI103-211DT	15 - 20 mm / M8	100
FH10-ICA8DT	SI101-211DT	4 - 10 mm / M8	100
FH10-ICA6DT	SI101-210DT	4 - 10 mm / M6	100
FH15-ICA6DT	SI102-210DT	10 - 15 mm / M6	100
FH4-ICA6DT	SI100-210DT	1,5 - 4 mm / M6	100
FH4-ICA10DT	SI100-212DT	1,5 - 4 mm / M10	100
FH10-ICA10DT	SI101-212DT	4 - 10 mm / M10	100

## PROFIELKLEMMEN ATTACHES POUR PROFILES

Voor kabelbinder  
Pour Collier de Câblage



BESTELNUMMER N° DE COMMANDE	Oud Ref. Ancienne réf.	Dikte profiel Epaisseur profile	
FH20-BRDT	SI103-250DT	15 - 20 mm	100
FH15-BRDT	SI102-250DT	10 - 15 mm	100
FH10-BRDT	SI101-250DT	4 - 10 mm	100
FH4-BRDT	SI100-250DT	1,5 - 4 mm	100

Klem - M6x9  
Attache - M6x9



BESTELNUMMER N° DE COMMANDE	Oud Ref. Ancienne réf.	Dikte profiel Epaisseur profile	
FU7TM6DT	SI104TM6DT	3 - 7 mm	100
FU12-5TM6DT	SI105TM6DT	7 - 13 mm	100
FU20TM6DT	SI106TM6DT	14 - 20 mm	100

Klem - M8x14  
Attache - M8x14



BESTELNUMMER N° DE COMMANDE	Oud Ref. Ancienne réf.	Dikte profiel Epaisseur profile	
FU7TM8DT	SI104TM8DT	3 - 7 mm	100
FU12-5TM8DT	SI105TM8DT	7 - 13 mm	100
FU20TM8DT	SI106TM8DT	14 - 20 mm	100

Klem - M8x14 Zonder Schroef  
Attache - M8x14 sans vis



BESTELNUMMER N° DE COMMANDE	Oud Ref. Ancienne réf.	Dikte profiel Epaisseur profile	
FU7DT	SI104DT	3 - 7 mm	100
FU12-5DT	SI105DT	7 - 13 mm	100
FU20DT	SI106DT	14 - 20 mm	100

## PROFIELKLEMMEN ATTACHES POUR PROFILES

Klem  
Attache

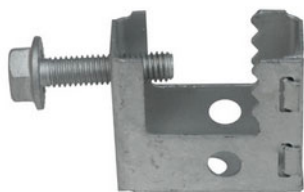

BESTELNUMMER N° DE COMMANDE	Oud Ref. Ancienne réf.	Dikte profiel Epaisseur profile	
SB17-11DT	SI130DT	max. 16 mm	100

CLIPS  
CLIPS



BESTELNUMMER N° DE COMMANDE	Oud Ref. Ancienne réf.	ø	Dikte profiel Epaisseur profile	
CD4-9DT	SI306DT	8 - 9 mm	1 - 4 mm	100
CD7-5-9DT	SI307DT	8 - 9 mm	4 - 7,5 mm	100
CD12-9DT	SI307.2DT	8 - 9 mm	7,5 - 12 mm	100
CD4-11DT	SI308DT	10 - 11 mm	1 - 4 mm	100
CD7-5-11DT	SI309DT	10 - 11 mm	4 - 7,5 mm	100
CD12-11DT	SI309.2DT	10 - 11 mm	7,5 - 12 mm	100
CD4-14DT	SI310DT	12 - 14 mm	1 - 4 mm	100
CD7-5-14DT	SI311DT	12 - 14 mm	4 - 7,5 mm	100
CD12-14DT	SI311.2DT	12 - 14 mm	7,5 - 12 mm	100
CD4-18DT	SI312DT	15 - 18 mm	1 - 4 mm	100
CD7-5-18DT	SI313DT	15 - 18 mm	4 - 7,5 mm	100
CD12-18DT	SI313.2DT	15 - 18 mm	7,5 - 12 mm	100
CD4-24DT	SI314DT	19 - 24 mm	1 - 4 mm	100
CD7-5-24DT	SI315DT	19 - 24 mm	4 - 7,5 mm	100
CD12-24DT	SI315.2DT	19 - 24 mm	7,5 - 12 mm	100
CD4-30DT	SI316DT	25 - 30 mm	1 - 4 mm	100
CD7-5-30DT	SI317DT	25 - 30 mm	4 - 7,5 mm	100



# PROFIELKLEMMEN ATTACHES POUR PROFILES

CLIPS

CLIPS



BESTELNUMMER N° DE COMMANDE	Oud Ref. Ancienne réf.	∅	Dikte profiel Epaisseur profile	
<b>CD12-30DT</b>	SI317.2DT	25 - 30 mm	7,5 - 12 mm	100

Rapid RTB dakplaathanger V model  
Attache RTB pour plaque de toit en V



BESTELNUMMER N° DE COMMANDE	Afm. Dim.	Dikte profiel Epaisseur profile	
<b>9004121</b>	M8 / M10	0.63 mm	50

TYPE RTB 8/10

Ponstang

Poinçon pour plaque de toit en V



BESTELNUMMER N° DE COMMANDE	
<b>9004510</b>	1

## ISOLATIETAPE RUBAN ISOLANT

Isolatietape 0,15 mm x 19 mm x 20 m

Ruban isolant 0,15 mm x 19 mm x 20 m



BESTELNUMMER N° DE COMMANDE	KLEUR	COULEUR	
TP151920BK	zwart	noir	10 / 250
TP151920BL	blauw	bleu	10 / 250
TP151920BN	bruin	brun	10 / 250
TP151920GRN	groen	vert	10 / 250
TP151920GY	groen-geel	vert-jaune	10 / 250
TP151920RD	rood	rouge	10 / 250
TP151920WT	wit	blanc	10 / 250
TP151920YL	geel	jaune	10 / 250
TP151920GR	grijs	gris	10 / 250

Vlamvertragend BSEN 60454-2

Flame retardant BSEN 60454-2

Isolatietape 0,15 mm x 50 mm x 20 m

Ruban isolant 0,15 mm x 50 mm x 20 m



BESTELNUMMER N° DE COMMANDE	KLEUR	COULEUR	
TP155020RD	rood	rouge	1 / 100
TP155020YL	geel	jaune	1 / 100

Vlamvertragend BSEN 60454-2

Flame retardant BSEN 60454-2

TOT UITPUTTING VAN DE STOCK / JUSQU'À ÉPUISEMENT DU STOCK

## SNELMONTAGE FIXATION RAPIDE

Universele nagelclips

Clips à clouer universels



BESTELNUMMER N° DE COMMANDE	∅	
<b>700-02</b>	2,5 - 4 mm	100 /12800
<b>700-05</b>	5 - 7 mm	100 /12800
<b>700-08</b>	8 - 10 mm	100 /9600
<b>700-11</b>	11 - 15 mm	100 /7500
<b>700-16</b>	16 - 19 mm	50 /500
<b>700-23</b>	23 - 29 mm	50 /250
<b>700-08 Black</b>	5 - 7 mm *	100 /9600

Met slechts 6 types alle maten in voorraad. Kleur: Grijs  
Avec seulement 6 types toutes dimensions en stock. Couleur: Gris

\* Black



Nagelclips - maten in mm

Attaches en clouer - mesures en mm



BESTELNUMMER N° DE COMMANDE	∅	
<b>3004-18</b>	4 mm	100 /12800
<b>3005-18</b>	5 mm	100 /12800
<b>3006-18</b>	6 mm	100 /12800
<b>3007-18</b>	7 mm	100 /12800
<b>3008-20</b>	8 mm	100 /12800
<b>3009-20</b>	9 mm	100 /12800
<b>3010-35</b>	10 mm	100 /12800
<b>3011-35</b>	11 mm	100 /12800
<b>3012-35</b>	12 mm	50 / 6400
<b>3014-40</b>	14 mm	50 / 5400
<b>3016-40</b>	16 mm	25 / 3250
<b>3018-40</b>	18 mm	25 / 3200
<b>3020-40</b>	20 mm	25 / 3200
<b>3007-18Black</b>	7 mm*	100 /12800

De 2 laatste cijfers van het bestelnummer duiden de lengte van de nagel aan. Kleur: Grijs

Les 2 derniers chiffres du n° de commande indiquent la longueur du clou. Couleur: Gris

\*Zwart / Noire



## SNELMONTAGE FIXATION RAPIDE

Nagelclips - maten in mm

Attaches à clouer - mesures en mm



BESTELNUMMER N° DE COMMANDE	ø IN	
<b>OL70211</b>	3/4 mm	100 /10000
<b>OL70212</b>	5/6 mm	100 /10000
<b>OL70213</b>	7/8 mm	100 /10000
<b>OL70214</b>	9/10 mm	100 /10000
<b>OL70215</b>	11/12 mm	100 /10000
<b>OL70216</b>	13/14 mm	100 /5000
<b>OL70217</b>	15/16 mm	100 /4000
<b>OL70218</b>	17/18 mm	100 /3000

De 2 laatste cijfers van het bestelnummer duiden de lengte van de nagel aan. Kleur: Grijs

Les 2 derniers chiffres du n° de commande indiquent la longueur du clou. Couleur: Gris



Nagelclips - Platte Kabel

Attaches à clouer - câble plat



BESTELNUMMER N° DE COMMANDE	ø	
<b>702-0</b>	2 x 0,75	100 /2000
<b>702-1</b>	2 x 1	100 /2000
<b>702-2</b>	2 x 1,5	100 /1000
<b>702-3</b>	2 x 2,5	100 /1000



Plugclips met nagel

Clips cheville avec clou



BESTELNUMMER N° DE COMMANDE	ø	
<b>300620W</b>	16 - 19 mm	200 / 3200
<b>300720W</b>	16 - 19 mm	100 / 1600



# SNELMONTAGE FIXATION RAPIDE

Enkel  
Simple



BESTELNUMMER N° DE COMMANDE	Ingangen Entrées	∅	
<b>601620</b>	1	16 - 20 mm	200 / 6000
<b>601922</b>	1	19 - 22 mm	125 / 3750
<b>602125</b>	1	21 - 25 mm	125 / 3750

Snelle betonmontage / Fixation beton rapide  
Kleur : wit / Couleur : blanc



Dubbel  
Double



BESTELNUMMER N° DE COMMANDE	Ingangen Entrées	∅	
<b>611620</b>	2	16 - 20 mm	125 / 3750
<b>611922</b>	2	19 - 22 mm	75 / 2250
<b>612125</b>	2	21 - 25 mm	60 / 1800

Snelle betonmontage / Fixation beton rapide  
Kleur : wit / Couleur : blanc



Plugclip in PVC - dubbel  
Clip cheville en PVC - double



BESTELNUMMER N° DE COMMANDE	Ingangen Entrées	∅	
<b>411620</b>	2	16 - 20 mm	120 / 3600

Snelle betonmontage / Fixation beton rapide  
Kleur : wit / Couleur : blanc



Pluggen  
Chevilles



BESTELNUMMER N° DE COMMANDE	∅	
<b>SEL712006</b>	6 mm	100 / 4000
<b>SEL712008</b>	8 mm	100 / 2500
<b>SEL712010</b>	10 mm	50 / 1250
<b>SEL712012</b>	12 mm	25 / 625

## SNELMONTAGE FIXATION RAPIDE

High cavity pluggen  
Chevilles à haute traction



BESTELNUMMER N° DE COMMANDE	∅	
<b>SELRXO101</b>	6 x 35 mm	100 / 1800
<b>SELRXO102</b>	8 x 50 mm	50 / 900

High cavity pluggen / Chevilles à haute traction

Nylon plug voor gipsplaten  
Cheville Nylon pour plaques de plâtre



BESTELNUMMER N° DE COMMANDE	∅	
<b>SELCOGO101</b>	12,3 x 29 mm	100 / 4000

Nylon plug met houtvijs kruis  
Cheville Nylon avec visse en croix



BESTELNUMMER N° DE COMMANDE	∅	
<b>SELPXV101</b>	6 x 60 mm	100 / 900

Nylon slagplug kruis  
Cheville Nylon à frapper



BESTELNUMMER N° DE COMMANDE	∅	
<b>SELCXP102</b>	5 X 30 mm	100/ 2000
<b>SELCXP104</b>	5 X 40 mm	100/ 2000
<b>SELCXP106</b>	6 x 40 mm	100 / 2000

## SNELMONTAGE FIXATION RAPIDE

Verzinkte spreidplug voor gipsplaten  
Cheville zinguée pour Gyproc



BESTELNUMMER N° DE COMMANDE	
9401001	200 / 4800

Messing pluggen  
Chevilles laiton



BESTELNUMMER N° DE COMMANDE	Afm. Dim.	
BA43-06	M6x8x22mm	1
BA43-08	M8x10x28mm	1
BA43-10	M10x12x32mm	1
BA43-12	M12x15x38mm	1

Kleur pluggen  
Chevilles de couleur



BESTELNUMMER N° DE COMMANDE	ø	KLEUR	COULEUR	
P1ES	5 mm	GEEL	JAUNE	100 / 2000
P2ES	5-5,5 mm	ROOD	ROUGE	100 / 2000
P3ES	7-8 mm	BRUIN	BRUN	100 / 2000

Montagebanden op rol - Recht  
Bandes de montage - Droit



BESTELNUMMER N° DE COMMANDE	Afm. Dim.	
250001	12 x 0,8 mm	10 / 900
250002	17 x 0,8 mm	10 / 600
250005	26 x 1,0 mm	10

## SNELMONTAGE FIXATION RAPIDE

Montagebanden op rol - Recht geplastificeerd  
Bandes de montage - Droit plastifiée



BESTELNUMMER N° DE COMMANDE	Afm. Dim.	
251001	14 mm	10/ 720
251002	19 mm	10/ 480

Montagebanden - Recht geplastificeerd - Rol in karton  
Bandes de montage - Droit Plastifié - Rouleau en carton



BESTELNUMMER N° DE COMMANDE	Afm. Dim.	
251001C	14 mm	10/ 720
251002C	19 mm	10/ 480

Montagebanden op rol - Rond  
Bandes de montage - Rond



BESTELNUMMER N° DE COMMANDE	Afm. Dim.	
350001	12 x 0,8 mm	10 / 900*
350002	17 x 0,8 mm	10 / 600*

\* Op aanvraag / Sur demande

Met Draad  
Avec Filetage



BESTELNUMMER N° DE COMMANDE	Afm. Dim.	
501018	M6 x 8 x 18	200 / 3200
501025	M6 x 8 x 25	200 / 3200
501030	M6 x 8 x 30	200 / 3200
501040	M6 x 8 x 40	100 / 2400



## SNELMONTAGE FIXATION RAPIDE

Zonder draad  
Sans filetage



BESTELNUMMER N° DE COMMANDE	∅	Afm. Dim.	
950418	Kraag/ Col 8 mm	4 x 18 mm	200 / 6400
960418	Kraag/ Col 10 mm	4 x 18 mm	200 / 6400

Drevel  
Chasse goujons



BESTELNUMMER N° DE COMMANDE	Afm. Dim.	
10012	M6	1

Drevel met rubber handbeschermer  
Chasse goujons avec protection caoutchouc



BESTELNUMMER N° DE COMMANDE	Afm. Dim.	
90HS4	4 mm	1
90HSM6	M6	1
90HSXXX	*	1

\* Herstellingsset / Set de réparation

Tacker clips voor vloerverwarming  
Tacker clips pour chauffage au sol



BESTELNUMMER N° DE COMMANDE	∅	Lengte Longueur	
TC57	12 - 20 mm	57 mm	1000/ 12000

per lader van 25 ST - Lengte 57mm  
par chargeur de 25 PCS - Longueur 57mm

## SNELMONTAGE FIXATION RAPIDE

Nietapparaat voor Tacker-nieten  
Pistolet pour Clips Tackers



BESTELNUMMER N° DE COMMANDE	∅	Lengte Longueur	
<b>TCGUN</b>	12 - 20 mm	57 mm	1

Lengte 57mm  
Longeur 57mm

# RAIL RAIL

## Omega-profielen zonder perforatie Rails Omega sans perforation



BESTELNUMMER N° DE COMMANDE	Afm. Dim.	Lengte Longueur	
<b>PD35Z</b>	7,5 x 35 mm	2m	40 m
<b>PD35CZ</b>	15 x 35 mm	2m	20 m

Sendzimir verzinkt staal  
Acier galvanisé Sendzimir

## Omega-profielen met perforatie Rails Omega avec perforation



BESTELNUMMER N° DE COMMANDE	Afm. Dim.	Lengte Longueur	
<b>PD35ZF6</b>	7,5 x 35 mm	2m	40 m
<b>PD35CZF6</b>	15 x 35 mm	2m	20 m
<b>PD15ZF4</b>	15 X 55 mm	2m	100 m
<b>PD32ZF6</b>	15/6 X 32 mm*	2M	20 m

Sendzimir verzinkt staal  
\*Asymmetrische  
Acier galvanisé Sendzimir  
\*Asymetrique

## Snijmachine RAIL Machine à couper RAIL



BESTELNUMMER N° DE COMMANDE	Afm. Dim.	Lengte Longueur	
<b>PDTR2M</b>	875 x 130 mm	2m	1

Voor / Pour : PD35Z - PD35CZ - PD35ZF6 - PD35CZF6

## Afbreekbare profielen Rails détachables



BESTELNUMMER N° DE COMMANDE	Specificiteit Spécificités	Afm. Dim.	
<b>2761</b>	*1	8 x 20 mm	100 m
<b>761</b>	*2	8 x 20 mm	50 m

Lengte / longueur : 2m  
\*1 Metal  
\*2 PVC

Ophangrail  
Rail de suspension



BESTELNUMMER N° DE COMMANDE	Afm. Dim.	
9200900	15 x 30 mm	2/20 m

Sendzimir verzinkt staal/Acier galvanisé Sendzimir  
Lengte/Longueur: 2m

## DRAADSTANG TIGE FILETEE

Draadstang verzinkt  
Tige filetée galvanisé



BESTELNUMMER N° DE COMMANDE	Afm. Dim.	
TR10006	M6x1000mm	1 / 100
TR10008	M8x1000mm	1 / 50
TR10010	M10x1000mm	1 / 25
TR10012	M12x1000mm	1 / 20
TR20006	M6x2000mm	1 / 50
TR20008	M8x2000mm	1 / 25
TR20010	M10x2000mm	1 / 25
TR20012	M12x2000mm	1 / 20
TR30006	M6x3000mm	1 / 50
TR30008	M8x3000mm	1 / 25
TR30010	M10x3000mm	1 / 25
TR30012	M12x3000mm	1 / 20

DIN 974 4.8  
Inox op aanvraag  
Inox sur demande

Afstandhouders  
Entretoises



BESTELNUMMER N° DE COMMANDE	Afm. Dim.	
5720	M6-30 mm	1
5721	M6-50 mm	1
5722	M6-100 mm	1
5725	M8-30 mm	1
5726	M8-50 mm	1
5727	M8-100 mm	1

Galva

Slaganker met plug M8/M10  
Cheville à frapper et cheville avec filetage interne M10/M8



BESTELNUMMER N° DE COMMANDE	
9401051	100



## DRAADSTANG TIGE FILETEE

Schroefanker met Plug M10/M8

Vis à béton et cheville avec filetage interne M10/M8



BESTELNUMMER N° DE COMMANDE	
9401052	50



Stokvijs

Vis sans tête



BESTELNUMMER N° DE COMMANDE	Afm. Dim.	
HB0050	M8-50 mm	100
HB0060	M8-60 mm	100
HB0070	M8-70 mm	100
HB0080	M8-80 mm	100
HB0100	M8-100 mm	100
HB0120	M8-120 mm	100
HB0150	M8-150 mm	100
HB0180	M8-180 mm	100

Schroef met houtdraad en metrische draadeindje voor M8 beugels

Vis à filetage bois et filetage métrique pour supports M8

Inslaganker met kraag

Douilles de frappe avec colerette



BESTELNUMMER N° DE COMMANDE	Afm. Dim.	
2014	M8	100
2016	M10	100
2012	M10	100



# FUNCTIE BEHOUD MAINTIENT DE FONCTION

Keilbout

Boulon expansible



BESTELNUMMER N° DE COMMANDE	Afm. Dim.	RAL	
4570	M8 x32		100



Brandwerend Schroefanker - MMS Plus

Vis à maintient de fonction - MMS Plus



BESTELNUMMER N° DE COMMANDE	Afm. Dim.	
9421	MMS-PLUS MS 7.5X40	50
9422	MMS-PLUS ST 6.0X55	50
9423	MMS-PLUS P 6.0X50	50
9424	MMS-PLUS P 6.0X35	50



# KABELBINDERS COLLIERS DE CÂBLAGE

Zwart  
Noir



BESTELNUMMER N° DE COMMANDE	Afm. Dim.	
SEL3201	75 x 2,5	100 / 5000
SEL3202	100 x 2,5	100 / 5000
SEL3203	135 x 2,5	100 / 5000
SEL3204	160 x 2,5	100 / 5000
SEL3205	200 x 2,5	100 / 5000
SEL3210	140 x 3,5	100 / 5000
SEL3211	200 x 3,5	100 / 5000
SEL3216	250 x 3,5	100 / 5000
SEL3212	280 x 3,5	100 / 5000
SEL3214	360 x 3,5	100 / 4000
SEL3220	140 x 4,5	100 / 5000
SEL3221	160 x 4,5	100 / 5000
SEL3222	180 x 4,5	100 / 5000
SEL3223	200 x 4,5	100 / 5000
SEL3224	250 x 4,5	100 / 5000
SEL3425	280 x 4,5	100 / 5000
SEL3429	300 x 4,5	100 / 4000
SEL3426	360 x 4,5	100 / 4000
SEL3427	380 x 4,5	100 / 3500
SEL3428	430 x 4,5	100 / 2500
SEL3430	180 x 7,5	100 / 2500
SEL3431	240 x 7,5	100 / 2000
SEL3432	200 x 7,5	100 / 5000
SEL3433	280 x 7,5	100 / 2000
SEL3438	320 x 7,5	100 / 1500
SEL3434	360 x 7,5	100 / 1500
SEL2435	450 x 7,5	100 / 2500
SEL3436	500 x 7,5	100 / 1000
SEL3441	750 x 7,5	100 / 700
SEL3144	430 x 9,0	100 / 1000
SEL3142	550 x 9,0	100 / 700
SEL3143	780 x 9,0	100 / 500
SEL3155	1220 x 9,0	100 / 500
SEL3150	250 x 12,5	50 / 500
SEL3447	360 x 6,0	100 / 1500
SEL3451	500 x 12,5	50 / 500
SEL3452	750 x 12,5	50 / 500
SEL3453	1000 x 12,5	50 / 500

Nylon PA 6.6





# KABELBINDERS COLLIERS DE CÂBLAGE

Wit  
Blanc



BESTELNUMMER N° DE COMMANDE	Afm. Dim.	
SEL2201	75 x 2,5	100 / 5000
SEL2202	100 x 2,5	100 / 5000
SEL2203	135 x 2,5	100 / 5000
SEL2204	160 x 2,5	100 / 5000
SEL2205	200 x 2,5	100 / 5000
SEL2210	140 x 3,5	100 / 5000
SEL2211	200 x 3,5	100 / 5000
SEL3215	225 x 3,5	100 / 5000
SEL2216	250 x 3,5	100 / 5000
SEL2212	280 x 3,5	100 / 5000
SEL2214	360 x 3,5	100 / 4000
SEL2220	140 x 4,5	100 / 5000
SEL2221	160 x 4,5	100 / 5000
SEL2222	180 x 4,5	100 / 5000
SEL2223	200 x 4,5	100 / 5000
SEL2224	250 x 4,5	100 / 5000
SEL2425	280 x 4,5	100 / 5000
SEL2429	300 x 4,5	100 / 4000
SEL2426	360 x 4,5	100 / 4000
SEL2427	380 x 4,5	100 / 3500
SEL2428	430 x 4,5	100 / 2500
SEL2430	180 x 7,5	100 / 2500
SEL2432	200 x 7,5	100 / 5000
SEL2431	240 x 7,5	100 / 2000
SEL2433	280 x 7,5	100 / 2000
SEL2438	320 x 7,5	100 / 1500
SEL2434	360 x 7,5	100 / 1500
SEL2435	450 x 7,5	100 / 2500
SEL2436	500 x 7,5	100 / 1000
SEL3437	540 x 7,5	100 / 2500
SEL2441	750 x 7,5	100 / 700
SEL2144	430 x 9,0	100 / 1000
SEL2142	550 x 9,0	100 / 700
SEL2143	780 x 9,0	100 / 500
SEL2155	1220 x 9,0	100 / 500
SEL2450	250 x 12,5	50 / 500
SEL2451	500 x 12,5	50 / 500
SEL2447	360 X 6,0	50 / 500
SEL2452	750 x 12,5	50 / 500
SEL2453	1000 x 12,5	50 / 500

Nylon PA 6.6



# KABELBINDERS COLLIERS DE CÂBLAGE

Kabelbinders gekleurd

Colliers de câblage colorés



Rood / Rouge RAL 3000  
 Blauw / Bleu RAL 5002  
 Groen / Vert RAL 6024  
 Geel / Jaune RAL 1201  
 Nylon PA 6.6



BESTELNUMMER N° DE COMMANDE	Afm. Dim.	KLEUR	COULEUR	
SEL.10.202R	100 x 2,5	Rood	Rouge	100 / 5000
SEL.10.210R	140 x 3,5	Rood	Rouge	100 / 5000
SEL.10.223R	200 x 4,5	Rood	Rouge	100 / 5000
SEL.10.425R	280 x 4,5	Rood	Rouge	100 / 5000
SEL.11.202R	100 x 2,5	Blauw	Bleu	100 / 5000
SEL.11.210R	140 x 3,5	Blauw	Bleu	100 / 5000
SEL.11.223R	200 x 4,5	Blauw	Bleu	100 / 5000
SEL.11.425R	280 x 4,5	Blauw	Bleu	100 / 5000
SEL.12.202R	100 x 2,5	Groen	Vert	100 / 5000
SEL.12.210R	140 x 3,5	Groen	Vert	100 / 5000
SEL.12.223R	200 x 4,5	Groen	Vert	100 / 5000
SEL.12.425R	280 x 4,5	Groen	Vert	100 / 5000
SEL.14.202R	100 x 2,5	Geel	Jaune	100 / 5000
SEL.14.210R	140 x 3,5	Geel	Jaune	100 / 5000
SEL.14.223R	200 x 4,5	Geel	Jaune	100 / 5000
SEL.14.425R	280 x 4,5	Geel	Jaune	100 / 5000

Kabelstrip wit - met markeerplaat 8 x 25 mm

Collier blanc - avec plaquette d'identification 8 x 25 mm



BESTELNUMMER N° DE COMMANDE	Afm. Dim.	
SEL.2.202T	100 x 2,5	100 / 5000

Nylon PA 6.6



## KABELBINDERS COLLIERS DE CÂBLAGE

Centuring Polyamide 12

Centuring Polyamide 12



BESTELNUMMER N° DE COMMANDE	Afm. Dim.	
<b>SEL3320</b>	180 x 9	100 / 3500
<b>SEL3321</b>	265 x 9	100 / 2000
<b>SEL3322</b>	360 x 9	100 / 1400
<b>SEL3323</b>	500 x 9	100 / 1000
<b>SEL3324</b>	750 x 9	100 / 1000



Spantang voor Centuring

Pince à sertir pour Centuring



BESTELNUMMER N° DE COMMANDE	∅	
<b>PIN005</b>	∅	1

Maximale breedte 9 mm

Largeur maximale 9 mm

Inox kabelbinders

Colliers de câblage en Inox



BESTELNUMMER N° DE COMMANDE	Afm. Dim.	
<b>SSCT1</b>	150x4.6	100
<b>SSCT2</b>	200x4.6	100
<b>SSCT3</b>	360x4.6	100
<b>SSCT4</b>	520x4.6	100
<b>SSCT5</b>	360x7.9	100
<b>SSCT6</b>	300x4.6	100
<b>SSCT7</b>	520x7.9	100

Plastic coating voor extra randbescherming.

Coating en plastic pour protection supplémentaire des côtés.

UV resistant, low smoke & HF.

# KABELBINDERS COLLIERS DE CÂBLAGE

Spantangen

Pinces à sertir



BESTELNUMMER N° DE COMMANDE	Specificiteit Spécificités	
PIN003-CTTN	*1	1
PIN006-CTTS	*2	1

\*1

Tang in metaal - Spantang tot 4,8 mm voor nylon - Snijdt zonder braam.

Pince en métal - Pince à serrage pour nylon jusqu'à 4,8 mm - Coupe sans morfil.

\*2

Tang in metaal. Spantang tot 7,9 mm voor metalen kabelbinders - Snijdt zonder braam.

Pince en métal - Pince à serrage pour colliers en métal jusqu'à 7,9 mm - Coupe sans morfil.

Nylon binders met Inox tand - naturel

Colliers en nylon avec dent en acier Inox - naturel



BESTELNUMMER N° DE COMMANDE	Afm. Dim.	
MET22102R	100 x 2,5	100
MET22105R	200 x 2,5	100
MET22110R	140 x 3,5	100
MET22111R	200 x 3,5	100
MET22112R	280 x 3,5	100
MET22123R	200 x 4,5	100
MET22126R	360 x 4,5	100
MET22140R	290 x 4,5	100
MET22534R	360 x 7,5	100



Nylon binders met Inox tand - zwart

Colliers en nylon avec dent en acier Inox - noir



BESTELNUMMER N° DE COMMANDE	Afm. Dim.	
MET32102R	100 x 2,5	100
MET32105R	200 x 2,5	100
MET32110R	140 x 3,5	100
MET32111R	200 x 3,5	100
MET32112R	280 x 3,5	100
MET32123R	200 x 4,5	100
MET32126R	360 x 4,5	100
MET32326R	360 X 4,5	100
MET32140R	290 x 4,5	100



# KABELBINDERS COLLIERS DE CÂBLAGE

Nylon binders met Inox tand - zwart  
Colliers en nylon avec dent en acier Inox - noir



BESTELNUMMER N° DE COMMANDE	Afm. Dim.	
<b>MET32534R</b>	360 x 7,5	100



Click Tie - herbruikbaar - Rood  
Click Tie - réouvrable et réutilisable - Rouge



BESTELNUMMER N° DE COMMANDE	Afm. Dim.	
<b>CLT102110R</b>	120 x 3,5	100 / 5000
<b>CLT102116R</b>	240 x 3,8	100 / 5000
<b>CLT102129R</b>	320 x 4,4	100 / 5000
<b>CLT102149R</b>	500 x 5,6	100 / 5000



Plug voor kabelbinders M8  
Cheville pour colliers de serrage M8



BESTELNUMMER N° DE COMMANDE	
<b>MF111</b>	100 / 3500

Plug voor kabelbinders tot 9 mm breed.  
Cheville pour collier de serrage jusqu'à 9 mm de largeur.



Zelfklevende 2-weg consoles  
Consoles adhésives double direction



BESTELNUMMER N° DE COMMANDE	Afm. Dim.	
<b>SEL2501</b>	ø 20 mm	100 / 3000
<b>SEL2502</b>	ø 28 mm	100 / 3000



## KABELBINDERS COLLIERS DE CÂBLAGE

Identificatieplaatje

Plaquette d'identification



BESTELNUMMER N° DE COMMANDE	Afm. Dim.	
<b>SEL101</b>	20x40x1,3mm	100 / 3000



Klipconsole 'Hooks' zelfklevend

Consoles clips 'Hooks' adhésifs



BESTELNUMMER N° DE COMMANDE	Afm. Dim.	
<b>SEL2401</b>	10 x 19	100 / 3000
<b>SEL2402</b>	13 x 26	100 / 3000
<b>SEL2403</b>	18 x 26	100 / 3000



# KABELSCHOENEN SOULIERS DE CABLE

Niet geïsoleerde kabelschoenen

Souliers de câbles non isolés



Vertind / Etamé

Geleidbaarheid / Conductivité : 99,9 % IACS BS 6017 - BS 1977

REMARQUE : Quand un câble souple est utilisé, il est nécessaire de sélectionner la dimension suivante plus grande.

Dimension en mm<sup>2</sup> du câble : le nombre du n° de commande avant le / : p.e. D035/10.

OPMERKING : Wanneer soepele kabels gebruikt worden, is het noodzakelijk de volgende grotere maat van kabelschoen te selecteren.

Afmeting in mm<sup>2</sup> van de kabel : het getal van het bestelnummer voor de / : bv. D035/10.

BESTELNUMMER N° DE COMMANDE	Ø
D006/05	5,2 mm
D006/06	6,5 mm
D006/08	8,4 mm
D010/05	5,2 mm
D010/06	6,5 mm
D010/08	8,4 mm
D010/10	10,5 mm
D016/05	5,2 mm
D016/06	6,5 mm
D016/08	8,4 mm
D016/10	10,5 mm
D025/06	6,5 mm
D025/08	8,4 mm
D025/10	10,5 mm
D035/06	6,5 mm
D035/08	8,4 mm
D035/10	10,5 mm
D035/12	13 mm
D050/06	6,5 mm
D050/08	8,4 mm
D050/10	10,5 mm
D050/12	13 mm
D070/08	8,4 mm
D070/10	10,5 mm
D070/12	13 mm
D070/14	15 mm
D095/08	8,4 mm
D095/10	10,5 mm
D095/12	13 mm
D095/14	15 mm
D120/10	10,5 mm
D120/12	13 mm
D120/14	15 mm
D150/08	8,4 mm
D150/10	10,5 mm
D150/12	13 mm
D150/14	15 mm
D185/10	10,5 mm
D185/12	13 mm
D185/14	15 mm
D240/12	13 mm
D240/14	15 mm
D240/16	17 mm

# KABELSCHOENEN SOULIERS DE CABLE

Doorverbinders

Raccords



Afmeting in mm<sup>2</sup> van de kabel/Dimensions en mm<sup>2</sup> du câble :

- 2,5 mm<sup>2</sup> voor DB02
- het getal na DB.. in het bestelnummer/le nombre après DB

BESTELNUMMER N° DE COMMANDE	ø IN	Afm. Dim.
<b>DB02</b>	ø 2,4 mm	1,5 mm <sup>2</sup>
<b>DB04</b>	ø 4 mm	2,5 mm <sup>2</sup>
<b>DB06</b>	ø 3,8 mm	06 mm <sup>2</sup>
<b>DB10</b>	ø 4,5 mm	10 mm <sup>2</sup>
<b>DB16</b>	ø 5,4 mm	16 mm <sup>2</sup>
<b>DB25</b>	ø 6,8 mm	25 mm <sup>2</sup>
<b>DB35</b>	ø 8,2 mm	35 mm <sup>2</sup>
<b>DB50</b>	ø 9,5 mm	50 mm <sup>2</sup>
<b>DB70</b>	ø 11,2 mm	70 mm <sup>2</sup>
<b>DB95</b>	ø 13,5 mm	95 mm <sup>2</sup>
<b>DB120</b>	ø 15 mm	120 mm <sup>2</sup>
<b>DB150</b>	ø 16,5 mm	150 mm <sup>2</sup>
<b>DB185</b>	ø 18,5 mm	185 mm <sup>2</sup>
<b>DB240</b>	ø 21 mm	240 mm <sup>2</sup>



## KABELSCHOENEN SOULIERS DE CABLE

Geïsoleerde kabelschoenen 0,5 à 1,5 mm<sup>2</sup>

Souliers de câbles isolés 0,5 à 1,5 mm<sup>2</sup>

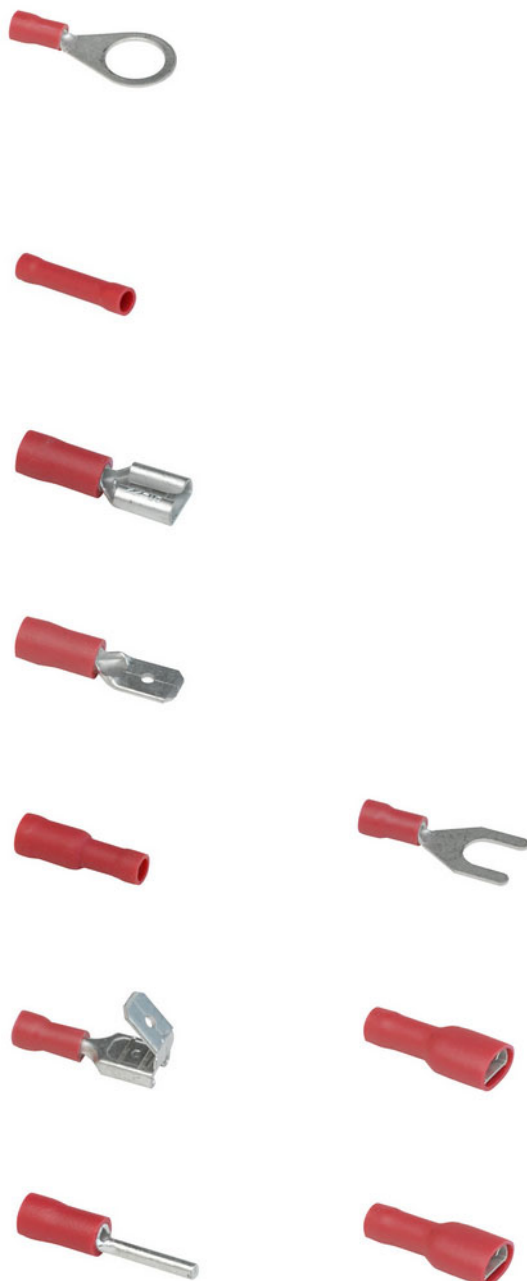

De geïsoleerde kabelschoenen zijn in koper en messing met hoge conductiviteit, vertind voor een verhoogde weerstand tegen corrosie.

Les cosses préisolées sont en cuivre et laiton de haute conductivité, étamés pour résistance à la corrosion.

Verpakking / emballage : 100 / 1000

BESTELNUMMER N° DE COMMANDE	Omschrijving	Description	ø
DVR1/03	Ring	Ring	3,2
DVR1/03.7	Ring	Ring	3,7
DVR1/04	Ring	Ring	4,3
DVR1/05	Ring	Ring	5,3
DVR1/06	Ring	Ring	6,4
DVR1/08	Ring	Ring	8,4
DVR1/10	Ring	Ring	10,5
DVR1/12	Ring	Ring	13
DVF1/03	Vork	Fourchette	3,2
DVF1/03.7	Vork	Fourchette	3,7
DVF1/04	Vork	Fourchette	4,3
DVF1/05	Vork	Fourchette	5,3
DVF1/06	Vork	Fourchette	6,4
DVPO1/4.8M	Doorverb. Mannelijk	Raccord mâle	-
DVPO1/6.3M	Doorverb. Mannelijk	Raccord mâle	-
DVPO1/2.8F	Doorverb. vrouwelijk	Raccord fémelle	
DVPO1/4.8F	Doorverb. vrouwelijk	Raccord fémelle	
DVPO1/6.3F	Doorverb. vrouwelijk	Raccord fémelle	
DVFP01/4.8F	Vrouwelijk geheel geïsoleerd	Fémelle complètement isolé	
DVFP01/6.3F	Vrouwelijk geheel geïsoleerd	Fémelle complètement isolé	
DVFP01/2.8F	Vrouwelijk geheel geïsoleerd	Fémelle complètement isolé	
DVPOA1/6.3	Mannelijk + vrouwelijk	Mâle + fémelle	
DVAB1M	Rond mannelijk	Mâle rond	
DVAB1F	Rond vrouwelijk	Fémelle rond	
DVBC1	Doorverb.	Raccord	
DVP1/09	Pin	Embout	9
DVP1/12	Pin	Embout	12

## KABELSCHOENEN SOULIERS DE CABLE

Geïsoleerde kabelschoenen 1,5 à 2,5 mm<sup>2</sup>

Souliers de câbles isolés 1,5 à 2,5 mm<sup>2</sup>



De geïsoleerde kabelschoenen zijn in koper en messing met hoge conductiviteit, vertind voor een verhoogde weerstand tegen corrosie.

Les cosses préisolées sont en cuivre et laiton de haute conductivité, étamés pour résistance à la corrosion.

Emb./Verp. : 100/1000

BESTELNUMMER N° DE COMMANDE	Omschrijving	Description	ø
DVR2/03	Ring	Plage oeil	3,2 mm
DVR2/03.7	Ring	Plage oeil	3,7 mm
DVR2/04	Ring	Plage oeil	4,3 mm
DVR2/05	Ring	Plage oeil	5,3 mm
DVR2/06	Ring	Plage oeil	6,4 mm
DVR2/08	Ring	Plage oeil	8,4 mm
DVR2/10	Ring	Plage oeil	10,5 mm
DVR2/12	Ring	Plage oeil	13 mm
DVF2/03	Vork	Fourchette	3,2 mm
DVF2/03.7	Vork	Fourchette	3,7 mm
DVF2/04	Vork	Fourchette	4,3 mm
DVF2/05	Vork	Fourchette	5,3 mm
DVF2/06	Vork	Fourchette	6,4 mm
DVPO2/6.3M	Doorverb. mannelijk	Raccord mâle	
DVPO2/2.8F	Doorverb. vrouwelijk	Raccord fémelle	
DVPO2/4.8F	Doorverb. vrouwelijk	Raccord fémelle	
DVPO2/6.3F	Doorverb. vrouwelijk	Raccord fémelle	
DVFP02/4.8F	Vrouwelijk geheel geïsoleerd	Fémelle compl. isolé	
DVFP02/6.3F	Vrouwelijk geheel geïsoleerd	Fémelle compl. isolé	
DVPOA2/6.3	Mannelijk + vrouwelijk	Mâle + fémelle	
DVAB2M	Rond mannelijk	Mâle rond	
DVAB2F	Rond vrouwelijk	Fémelle rond	
DVBC2	Doorverb.	Raccord	
DVP2/09	Pin	Embout	9
DVP2/12	Pin	Embout	12

## KABELSCHOENEN SOULIERS DE CABLE

Geïsoleerde kabelschoenen 4 à 6 mm<sup>2</sup>

Souliers de câbles isolés 4 à 6 mm<sup>2</sup>



BESTELNUMMER N° DE COMMANDE	Omschrijving	Description	ø
DVR5/04	Ring	Plage oeil	4,3 mm
DVR5/05	Ring	Plage oeil	5,3 mm
DVR5/06	Ring	Plage oeil	6,4 mm
DVR5/08	Ring	Plage oeil	8,4 mm
DVR5/10	Ring	Plage oeil	10,5 mm
DVR5/12	Ring	Plage oeil	13 mm
DVF5/ 03	Vork	Fourchette	3,7 mm
DVF5/ 04	Vork	Fourchette	4,3 mm
DVF5/05	Vork	Fourchette	5,3 mm
DVF5/06	Vork	Fourchette	6,4 mm
DVF5/08	Vork	Fourchette	8 mm
DVP O 5 /6 .3 M	Doorverb. mannelijk	Raccord mâle	
DVP O 5 /6 .3 F	Doorverb. vrouwelijk	Raccord fémelle	
DVP O 5 /9 .5 F	Doorverb. vrouwelijk	Raccord fémelle	
DVFP O5 /6.3F	Vrouwelijk geheel geïsoleerd	Fémelle complètem isolé	
DVFP O5 /9.5F	Vrouwelijk geheel geïsoleerd	Fémelle complètem isolé	
DVBC 5	Doorverb.	Raccord	
DVP 5/ 1 4	Pin	Embout	14

De geïsoleerde kabelschoenen zijn in koper en messing met hoge conductiviteit, vertind voor een verhoogde weerstand tegen corrosie.

Les cosses préisolées sont en cuivre et laiton de haute conductivité, étamés pour résistance à la corrosion.

Emb./ Verp. : 100/1000

## PVC KANALEN CANAUX PVC

Type G - Grijs

Type G - Gris



BESTELNUMMER N° DE COMMANDE	Breedte x Hoogte Largeur x Hauteur	
G16	25x30 mm	80 m
G23	40x30 mm	48 m
G24	60x30 mm	32 m
G13	25x40 mm	60 m
G8	40x40 mm	40 m
G4	60x40 mm	24 m
G26	80x40 mm	24 m
G27	100x40 mm	16 m
G28	120x40 mm	20 m
G7	25x60 mm	40 m
G5	40x60 mm	36 m
G9	60x60 mm	24 m
G6	80x60 mm	24 m
G17	100x60 mm	20 m
G10	120x60 mm	16 m
G30	150x60 mm	12 m
G31	200x60 mm	8 m
G50	250x70 mm	8 m
G14	25x80 mm	32 m
G15	40x80 mm	24 m
G11	60x80 mm	24 m
G12	80x80 mm	24 m
G19	100x80 mm	16 m
G32	120x80 mm	16 m
G33	150x80 mm	12 m
G48	200x80 mm	8 m
G35	40x100 mm	16 m
G18	60x100 mm	16 m
G37	100x100 mm	16 m
G38	120x100 mm	8 m
G39	150x100 mm	8 m
G40	200x100 mm	8 m
G43	100x150 mm	8 m

Lengte : 2 meter

Kleur : Grijs RAL 7030

Deksel inbegrepen

Longueur : 2 mètres

Couleur : Gris RAL 7030

Couvercle inclus

LIJST VAN DE TOEBEHOREN - ZIE WWW.GSV.BE

LISTE DES ACCESSOIRES - SUR WWW.GSV.BE

## PVC KANALEN CANAUX PVC

Type G - 1,3 m - Grijs

Type G - 1,3 m - Gris



BESTELNUMMER N° DE COMMANDE	Breedte x Hoogte Largeur x Hauteur	
<b>G4EK</b>	60x40 mm	15,6 m
<b>G17EK</b>	100x60 mm	13 m
<b>G31EK</b>	200x60 mm	6 m
<b>G40EK</b>	200x100 mm	5,2 m
<b>G50EK</b>	250x70 mm	5,2 m

Lengte : 1,3 meter

Kleur : Grijs RAL 7030

Deksel inbegrepen

Longueur : 1,3 mètres

Couleur : Gris RAL 7030

Couvercle inclus

LIJST VAN DE TOEBEHOREN - ZIE WWW.GSV.BE

LISTE DES ACCESSOIRES - SUR WWW.GSV.BE

OP AANVRAAG / SUR DEMANDE

Type G - Wit

Type G - Blanc



BESTELNUMMER N° DE COMMANDE	Breedte x Hoogte Largeur x Hauteur	
<b>G16BEU</b>	25x30 mm	80 m
<b>G23BEU</b>	40x30 mm	48 m
<b>G8BEU</b>	40x40 mm	40 m
<b>G4BEU</b>	60x40 mm	24 m
<b>G27BEU</b>	100x40 mm	16 m
<b>G9BEU</b>	60x60 mm	24 m
<b>G6BEU</b>	80x60 mm	24 m
<b>G17BEU</b>	100x60 mm	20 m
<b>G10BEU</b>	120x60 mm	16 m
<b>G30BEU</b>	150x60 mm	12 m
<b>G31BEU</b>	200x60 mm	8 m
<b>G50BEU</b>	250x70 mm	8 m
<b>G19BEU</b>	100x80 mm	16 m
<b>G33BEU</b>	150x80 mm	12 m
<b>G48BEU</b>	200x80 mm	8 m
<b>G40BEU</b>	200x100 mm	8 m

Lengte : 2 meter Kleur : Wit RAL 9010

Deksel inbegrepen

Longueur : 2 mètres

Couleur : Blanc RAL 9010

Couvercle inclus

LIJST VAN DE TOEBEHOREN - ZIE WWW.GSV.BE

LISTE DES ACCESSOIRES - SUR WWW.GSV.BE

# PVC KANALEN CANAUX PVC

Type G - 1,3 m - Wit  
 Type G - 1,3 m - Blanc



BESTELNUMMER N° DE COMMANDE	Breedte x Hoogte Largeur x Hauteur	
<b>G17EKBEU</b>	100x60 mm	5,2 m*
<b>G31EKBEU</b>	200x60 mm	5,2 m
<b>G40EKBEU</b>	200x100 mm	5,2 m
<b>G50EKBEU</b>	250x70 mm	5,2 m

Lengte : 1,3 meter  
 Kleur : Wit RAL 9010  
 Compleet met deksel  
 Longueur : 1,3 mètres  
 Couleur : Blanc RAL 9010  
 Complet avec couvercle  
 LIJST VAN DE TOEBEHOREN - ZIE WWW.GSV.BE  
 LISTE DES ACCESSOIRES - SUR WWW.GSV.BE  
 \*OP AANVRAAG - SUR DEMANDE

Type G - 1,5 m - Wit  
 Type G - 1,5 m - Blanc



BESTELNUMMER N° DE COMMANDE	Breedte x Hoogte Largeur x Hauteur	
<b>G31KBEU</b>	200x60 mm	6 m
<b>G50KBEU</b>	250x70 mm	6 m

Lengte : 1,5 meter  
 Kleur : Wit RAL 9010  
 Compleet met deksel  
 Longueur : 1,5 mètres  
 Couleur : Blanc RAL 9010  
 Complet avec couvercle  
 LIJST VAN DE TOEBEHOREN - ZIE WWW.GSV.BE  
 LISTE DES ACCESSOIRES - SUR WWW.GSV.BE

Type E - 12-8 mm  
 Type E - 12-8 mm



BESTELNUMMER N° DE COMMANDE	Breedte x Hoogte Largeur x Hauteur	
<b>E20</b>	15 x 17 mm	120 m
<b>E22</b>	15 x 30 mm	80 m
<b>E16</b>	25 x 30 mm	80 m
<b>E23</b>	40 x 30 mm	48 m
<b>E24</b>	60 x 30 mm	32 m
<b>E25</b>	15 x 40 mm	72 m
<b>E13</b>	25 x 40 mm	60 m
<b>E8</b>	40 x 40 mm	40 m

Lengte : 2 meter  
 Kleur : Grijs RAL 7030  
 Deksel inbegrepen  
 Longueur : 2 mètres  
 Couleur : Gris RAL 7030  
 Couvercle inclus

# PVC KANALEN CANAUX PVC

Type E - 12-8 mm

Type E - 12-8 mm



BESTELNUMMER N° DE COMMANDE	Breedte x Hoogte Largeur x Hauteur	
E4	60 x 40 mm	24 m
E26	80 x 40 mm	24 m
E27	100 x 40 mm	16 m
E28	120 x 40 mm	16 m
E7	25 x 60 mm	40 m
E5	40 x 60 mm	36 m
E9	60 x 60 mm	24 m
E6	80 x 60 mm	24 m
E17	100 x 60 mm	20 m
E10	120 x 60 mm	16 m
E30	150 x 60 mm	12 m
E31	200 x 60 mm	8 m
E14	25 x 80 mm	32 m
E15	40 x 80 mm	24 m
E11	60 x 80 mm	24 m
E12	80 x 80 mm	24 m
E19	100 x 80 mm	16 m
E32	120 x 80 mm	16 m
E33	150 x 80 mm	12 m
E48	200 x 80 mm	8 m
E34	25 x 100 mm	24 m
E35	40 x 100 mm	16 m
E18	60 x 100 mm	16 m
E36	80 x 100 mm	16 m
E37	100 x 100 mm	16 m
E38	120 x 100 mm	8 m
E39	150 x 100 mm	8 m
E40	200 x 100 mm	8 m
E43	100 x 150 mm	8 m

Lengte : 2 meter  
 Kleur : Grijs RAL 7030  
 Deksel inbegrepen  
 Longueur : 2 mètres  
 Couleur : Gris RAL 7030  
 Couvercle inclus

# PVC KANALEN CANAUX PVC

Type E - DIN - 7,5-5 mm

Type E - DIN - 7,5-5 mm

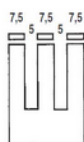

BESTELNUMMER N° DE COMMANDE	Breedte x Hoogte Largeur x Hauteur	
<b>ED2525</b>	25 x 25 mm	84 m
<b>ED2537</b>	25 x 37,5 mm	64 m
<b>ED3737</b>	37,5 x 37,5 mm	48 m
<b>ED2550</b>	25 x 50 mm	52 m
<b>ED3750</b>	37,5 x 50 mm	32 m
<b>ED5050</b>	50 x 50 mm	24 m
<b>ED7550</b>	75 x 50 mm	24 m
<b>ED10050</b>	100 x 50 mm	16 m
<b>ED2575</b>	25 x 75 mm	32 m
<b>ED3775</b>	37,5 x 75 mm	32 m
<b>ED5075</b>	50 x 75 mm	24 m
<b>ED7575</b>	75 x 75 mm	16 m
<b>ED10075</b>	100 x 75 mm	16 m
<b>ED12575</b>	125 x 75 mm	12 m

Lengte/Longueur : 2 m

Kleur/Couleur : Grijs/Gris RAL 7030

Deksel inbegrepen/ Couvercle Inclus

OP AANVRAAG / SUR DEMANDE

Verkrijgbaar in halogeenvrije uitvoering.

Disponible en version sans halogène.

Type E - 6-4 mm

Type E - 6-4 mm



BESTELNUMMER N° DE COMMANDE	Breedte x Hoogte Largeur x Hauteur	
<b>E164</b>	25 x 30 mm	80 m
<b>E134</b>	25 x 40 mm	60 m
<b>E84</b>	40 x 40 mm	40 m
<b>E44</b>	60 x 40 mm	24 m
<b>E264</b>	80 x 40 mm	24 m
<b>E74</b>	25 x 60 mm	40 m
<b>E54</b>	40 x 60 mm	36 m
<b>E94</b>	60 X 60 mm	24 m
<b>E64</b>	80 x 60 mm	24 m
<b>E174</b>	100 x 60 mm	20 m
<b>E104</b>	120 x 60 mm	16 m
<b>E144</b>	25 x 80 mm	32 m
<b>E154</b>	40 x 80 mm	24 m
<b>E114</b>	60 x 80 mm	24 m

Lengte : 2 meter

Kleur : Grijs RAL 7030

Deksel inbegrepen

Longueur : 2 mètres

Couleur : Gris RAL 7030

Couvercle inclus



# PVC KANALEN CANAUX PVC

Type E - 6-4 mm

Type E - 6-4 mm

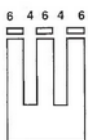

BESTELNUMMER N° DE COMMANDE	Breedte x Hoogte Largeur x Hauteur	
E124	80 x 80 mm	24 m
E194	100 x 80 mm	16 m
E324	120 x 80 mm	16 m
E344	25 x 100 mm	24 m
E354	40 x 100 mm	16 m
E184	60 x 100 mm	16 m
E364	80 x 100 mm	16 m
E374	100 x 100 mm	16 m

Lengte : 2 meter  
 Kleur : Grijs RAL 7030  
 Deksel inbegrepen  
 Longueur : 2 mètres  
 Couleur : Gris RAL 7030  
 Couvercle inclus

Dwarsclips voor type E

Traverses pour type E



BESTELNUMMER N° DE COMMANDE	Afm. Dim.	
PTR	100 mm	25 / 100
TR06	60 mm	1
TR08	80 mm	1
TR10	100 /120 mm	1

Klinknagels en Drevel voor dito

Rivets et Chasse pour dito





BESTELNUMMER N° DE COMMANDE	Specificiteit Spécificités	Afm. Dim.	
RIV1	Zwart/ Noir	ø 6,5-7 mm	200
RIV2	Groen/ Vert	ø 4,5-5,5 mm	200
PRRIV1	Tool	RIV1	1
PRRIV2	Tool	RIV2	1

## PVC KANALEN CANAUX PVC

Type E - 6-6,5 mm - LSOH

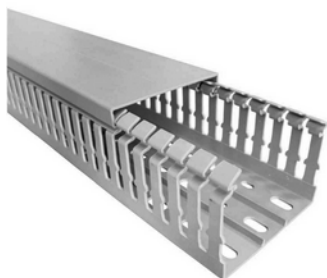
Type E - 6-6,5 mm - LSOH



BESTELNUMMER N° DE COMMANDE	Breedte x Hoogte Largeur x Hauteur	
V6H2525	25 x 25 mm	50
V6H4025	25 x 40 mm	48
V6H4040	40 x 40 mm	50
V6H4060	60 x 40 mm	50
V6H4080	80 x 40 mm	30
V6H6025	25 x 60 mm	60
V6H6040	40 x 60 mm	40
V6H6060	60 x 60 mm	24
V6H6080	80 x 60 mm	20
V6H60100	100 x 60 mm	16
V6H60120	120 x 60 mm	12
V6H8025	25 x 80 mm	20
V6H8040	40 x 80 mm	20
V6H8060	60 x 80 mm	20
V6H8080	80 x 80 mm	12
V6H80100	100 x 80 mm	12
V6H80120	120 x 80 mm	16
V6H10060	60 x 100 mm	16
V6H10080	80 x 100 mm	16
V6H100100	100 x 100 mm	12

Lengte : 2 meter Kleur :  
Grijs RAL 7035  
Deksel inbegrepen  
Longueur : 2 mètres  
Couleur : Gris RAL 7035  
Couvercle inclus



Kniptang voor bedradingskanalen type E  
Pince pour goulottes type E



BESTELNUMMER N° DE COMMANDE	
ECUT	1

# PVC KANALEN CANAUX PVC

Snijmachine voor type E

Machine à couper pour goulottes type E



BESTELNUMMER N° DE COMMANDE	
<b>WAB05200</b>	1
<b>ETC120</b>	1

Maximale afmeting : 120 x 120 mm

Zowel voor PVC als HF

Dimension maximale : 120 x 120 mm

Pour PVC comme pour HF

Deksels voor type E en G - Grijs

Couvercles pour type E et G - Gris

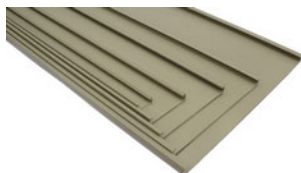

BESTELNUMMER N° DE COMMANDE	Afm. Dim.	Lengte Longueur
<b>GCOP025</b>	25 mm	2 m
<b>GCOP040</b>	40 mm	2 m
<b>GCOP060</b>	60 mm	2 m
<b>GCOP080</b>	80 mm	2 m
<b>GCOP100</b>	100 mm	2 m
<b>GCOP120</b>	120 mm	2 m
<b>GCOP150</b>	150 mm	2 m
<b>GCOP200</b>	200 mm	2 m

RAL 7030

Deksels voor type G - Wit

Couvercles pour type G - Blanc



BESTELNUMMER N° DE COMMANDE	Afm. Dim.	Lengte Longueur
<b>GCOP100BEU</b>	100 mm	2 m
<b>GCOP120BEU</b>	120 mm	2 m
<b>GCOP150BEU</b>	150 mm	2 m
<b>GCOP200BEU</b>	200 mm	2 m

RAL 9010

## PVC KANALEN CANAUX PVC

Scheidingschotten voor type E en G  
Séparations pour type E et G



BESTELNUMMER N° DE COMMANDE	Afm. Dim.	Lengte Longueur	
<b>S1</b>	40 mm	2 m	60 m
<b>S2</b>	60 mm	2 m	50 m

RAL 7030

Kabelhouders voor type E en G  
Clips de câble pour type E et G



BESTELNUMMER N° DE COMMANDE	Afm. Dim.	
<b>FCV12040</b>	40/120x40 mm	100
<b>FCV12060</b>	40/200x60 mm	100

Kanalen voor Airco - Wit  
Canaux pour Air Conditionné - Blanc



BESTELNUMMER N° DE COMMANDE	Breedte x Hoogte Largeur x Hauteur	
<b>CON30</b>	35 x 30 mm	64 m
<b>CON70</b>	70 x 55 mm	24 m
<b>CON90</b>	90 x 65 mm	16 m
<b>CON125</b>	125 x 75 mm	8 m

UV bestendig Class1  
Résistance UV Class1  
Deksel inbegrepen  
Lengte : 2 meter  
Kleur : Wit RAL 9010  
Couvercle inclus  
Longueur : 2 mètres  
Couleur : Blanc RAL 9010  
LIJST VAN DE TOEBEHOREN - ZIE WWW.GSV.BE  
LISTE DES ACCESSOIRES - SUR WWW.GSV.BE

Kanalen voor Airco - Bruin  
Canaux pour Air Conditionné - Marron



BESTELNUMMER N° DE COMMANDE	Breedte x Hoogte Largeur x Hauteur	
<b>CON30M</b>	35 x 30 mm	64 m
<b>CON70M</b>	70 x 55 mm	24 m
<b>CON90M</b>	90 x 65 mm	16 m
<b>CON125M</b>	125 x 75 mm	8 m

UV bestendig Class1  
Résistance UV Class1  
Deksel inbegrepen  
Lengte : 2 meter  
Couvercle inclus  
Longueur : 2 mètres  
Kleur : Bruin RAL 8017  
Couleur : Marron RAL 8017  
LIJST VAN DE TOEBEHOREN - ZIE WWW.GSV.BE  
LISTE DES ACCESSOIRES - SUR WWW.GSV.BE

## VLOERKANALEN CANAUX DE SOL

Vloerkanalen  
Canaux de sol



BESTELNUMMER N° DE COMMANDE	Specificiteit Spécificités	Breedte x Hoogte Largeur x Hauteur	
<b>ZBFG</b>		75 x 16 mm	40 m
<b>ZBFG-M</b>	*	50 x 12 mm	60 m
<b>ZBFB</b>		75 x 16 mm	40 m

Lengte / Longueur : 2 m

ZBFG : Kleur/Couleur = grijs/gris

ZBFB : Kleur/Couleur = wit/blanc

## MINIKANALEN MINI GOULOTTE

Zelfklevende mini kanalen  
Canaux mini autoadhésifs



BESTELNUMMER N° DE COMMANDE	Breedte x Hoogte Largeur x Hauteur	
<b>J1207PAD</b>	12 x 7 mm	160 m
<b>J1610PAD</b>	16 x 10 mm	90 m

Met clic-deksel inbegrepen  
Lengte : 2 meter  
Avec couvercle clic  
Longueur : 2 mètres  
Wit / Blanc

Minikanalen type BS  
Canaux mini type BS



BESTELNUMMER N° DE COMMANDE	Breedte x Hoogte Largeur x Hauteur	
<b>BS11BEU</b>	16 x 16 mm	92 m
<b>BS21BEU</b>	25 x 16 mm	72 m
<b>BS61BEU</b>	60 x 16 mm	36 m

Deksel inbegrepen  
Lengte : 2 meter  
Couvercle inclus  
Longueur : 2 mètres

TYPE G  
TYPE G



BESTELNUMMER N° DE COMMANDE	Breedte x Hoogte Largeur x Hauteur	RAL	
<b>G20BEU</b>	15 x 18 mm	RAL 9010	120 m
<b>G41BEU</b>	20 x 10 mm	RAL 9010	120 m
<b>G44BEU</b>	25 x 20 mm	RAL 9010	60 m
<b>G45BEU</b>	40 x 20 mm	RAL 9010	42 m

Deksel inbegrepen  
Lengte : 2 meter  
Couvercle inclus  
Longueur : 2 mètres  
Wit - Blanc

## MINIKANALEN MINI GOULOTTE

Toebehoren voor mini TYPE G

Accessoires pour MINI TYPE G



BESTELNUMMER N° DE COMMANDE	Omschrijving	Description	Breedte x Hoogte Largeur x Hauteur	
41E	Buitenhoek	Angle Exterieur	20 x 10 mm	10
44E	Buitenhoek	Buitenhoek	25 x 20 mm	5
GT248EB	Buitenhoek	Buitenhoek	40 x 20 mm	5
41I	Binnenhoek	Angle intérieur	20 x 10 mm	10
44I	Binnenhoek	Angle intérieur	25 x 20 mm	5
GT248IB	Binnenhoek	Angle intérieur	40 x 20 mm	5
41L	Vlakke Hoek	Angle Exterieur	20 x 10 mm	10
44L	Vlakke Hoek	Angle Exterieur	25 x 20 mm	5
GT248LB	Vlakke Hoek	Angle Exterieur	40 x 20 mm	5
41T	T Stuk	Dérivation T	20 x 10 mm	10
44T	T Stuk		25 x 20 mm	5
GT248TB	T Stuk	Dérivation T	40 x 20 mm	5
41G	Koppelstuk	Raccord	20 x 10 mm	10
44G	Koppelstuk	Raccord	25 x 20 mm	5
GT248GB	Koppelstuk	Raccord	40 x 20 mm	5
41S	Eindstuk	Embout	20 x 10 mm	10
GT16A	Eindstuk	Embout	25 x 20 mm	5
20BLI	Set voor G20B*	Set pour G20B*	15 x 18 mm	1
GT248AB	Eindstuk	Embout	40 x 20 mm	5

Set : 20BLI = Blisterverpakking met toebehoren voor de G20B met : 1 Buitenhoek + 1 Binnenhoek + 2 Vlakke hoeken + 1 T-stuk + 1 Koppeling + 1 Eindstuk

Set : 20BLI = Emballage blister avec les accessoires pour la G20B incluant : 1 Angle extérieur + 1 Angle intérieur + 2 Angles plat + 1 Déviation-T + 1 Raccord + 1 Pièce terminale



# MINIKANALEN MINI GOULOTTE

TYPE INWAY

TYPE INWAY

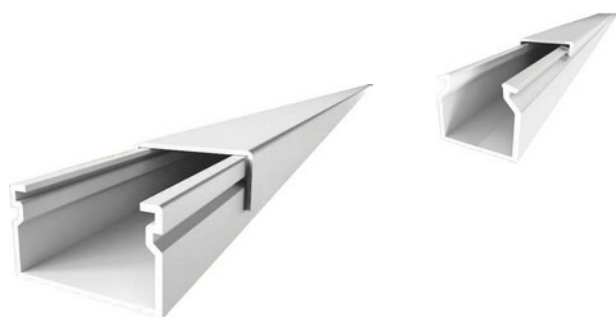

BESTELNUMMER N° DE COMMANDE	Breedte x Hoogte Largeur x Hauteur	RAL	
IW2012.5B	20 x 12,5 mm	RAL 9010	80m
IW4017B	40 X 17 mm	RAL 9010	32m

Deksel inbegrepen / Couvercle inclus  
Lengte / Longueur : 2 meter

Mini Inway - Toebehoren

Mini Inway - Accessoires



BESTELNUMMER N° DE COMMANDE	Omschrijving	Description	Breedte x Hoogte Largeur x Hauteur
IWAE2012B	Buitenhoek	Angle extérieur	20 x 12,5 mm
IWAE4017B	Buitenhoek	Angle extérieur	40 x 17 mm
IWAI2012B	Binnenhoek	Angle intérieur	20 x 12,5 mm
IWAI4017B	Binnenhoek	Angle intérieur	40 x 17 mm
IWAP2012B	Vlakke hoek	Angle Plat	20 x 12,5 mm
IWAP4017B	Vlakke hoek	Angle Plat	40 x 17 mm
IWGT2012B	T	Dérivation "T"	20 x 12,5 mm
IWGT4017B	T	Dérivation "T"	40 x 17 mm
IWGU2012B	Koppelstuk	Joint	20 x 12,5 mm
IWGU4017B	Koppelstuk	Joint	40 x 17 mm
IWTT2012B	Eindstuk	Embout	20 x 12,5 mm
IWTT4017B	Eindstuk	Embout	40 x 17 mm

NIEUW  
NOUVEAU  
REF.

HALOGEN  
FREE

# MINIKANALEN MINI GOULOTTE

TYPE INWAY BLACK

TYPE INWAY BLACK

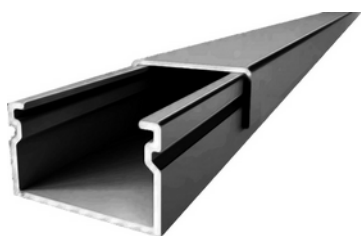

BESTELNUMMER N° DE COMMANDE	Breedte x Hoogte Largeur x Hauteur	RAL	
IW2012.5Black	20 X 12,5 mm	RAL 9005	80 m
IW4017Black	40 x 17 mm	RAL 9005	30 m

Deksel inbegrepen / Couvercle inclus  
Lengte / Longueur : 2 meter



Mini Inway Black - Toebehoren

Mini Inway Black - Accessoires



BESTELNUMMER N° DE COMMANDE	Omschrijving	Description	Breedte x Hoogte Largeur x Hauteur
IWAE2012Black	Buitenhoek	Angle extérieur	20 x 12,5 mm
IWAE4017Black	Buitenhoek	Angle extérieur	40 x 17 mm
IWAI2012Black	Binnenhoek	Angle intérieur	20 x 12,5 mm
IWAI4017Black	Binnenhoek	Angle intérieur	40 x 17 mm
IWAP2012Black	Vlakke hoek	Angle Plat	20 x 12,5 mm
IWAP4017Black	Vlakke hoek	Angle Plat	40 x 17 mm
IWGT2012Black	"T" stuk	Dérivation "T"	20 x 12,5 mm
IWGT4017Black	"T" stuk	Dérivation "T"	40 x 17 mm
IWGU2012Black	Koppelstuk	Joint	20 x 12,5 mm
IWGU4017Black	Koppelstuk	Joint	40 x 17 mm
IWTT2012Black	Eindstuk	Embout	20 x 12,5 mm
IWTT4017Black	Eindstuk	Embout	40 x 17 mm



# MINI KANALEN LSOH GOULOTTES MINI LSOH

TYPE INWAY LSOH

TYPE INWAY LSOH

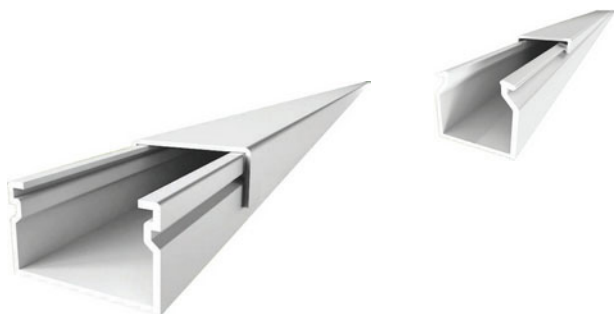

BESTELNUMMER N° DE COMMANDE	Breedte x Hoogte Largeur x Hauteur	RAL	
IW20125LH	20 x 12,5 mm	RAL 9010	80m
IW2020LH	20 x 20 mm	RAL 9010	50m
IW4017LH	40 X 17 mm	RAL 9010	30m
IW6040LH	60 x 40 mm	RAL 9010	32m

Deksel inbegrepen  
Lengte : 2 meter  
Couvercle inclus  
Longueur : 2 mètres



TYPE INWAY BLACK LSOH

TYPE INWAY BLACK LSOH

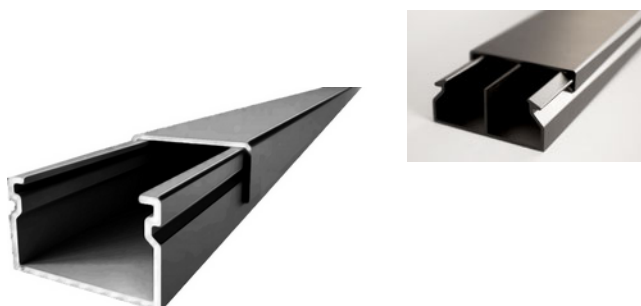

BESTELNUMMER N° DE COMMANDE	Breedte x Hoogte Largeur x Hauteur	RAL	
IW2012.5LHBlack	20 X 12,5 mm	RAL 9005	80 m
IW4017LHBlack	40 x 17 mm	RAL 9005	30 m

Deksel inbegrepen  
Lengte : 2 meter  
Couvercle inclus  
Longueur : 2 mètres  
OP AANVRAAG - SUR DEMANDE



LHD

LHD



BESTELNUMMER N° DE COMMANDE	Breedte x Hoogte Largeur x Hauteur	RAL	
LHD2010HF	20 x 10 mm	RAL 9003	96 m
LHD2020HF	20 x 20 mm	RAL 9003	48 m
LHD4020HF	40 x 20 mm	RAL 9003	24 m

Deksel inbegrepen  
Lengte : 2 meter  
Couvercle inclus  
Longueur : 2 mètres  
LIJST VAN DE TOEBEHOREN - ZIE WWW.GSV.BE  
LISTE DES ACCESSOIRES - SUR WWW.GSV.BE



## MINI KANALEN LSOH GOULOTTES MINI LSOH

LHD

LHD



BESTELNUMMER N° DE COMMANDE	Breedte x Hoogte Largeur x Hauteur	RAL	
<b>LHD4040HF</b>	40 x 40 mm	RAL 9003	20 m

Deksel inbegrepen  
 Lengte : 2 meter  
 Couvercle inclus  
 Longueur : 2 mètres  
 LIJST VAN DE TOEBEHOREN - ZIE WWW.GSV.BE  
 LISTE DES ACCESSOIRES - SUR WWW.GSV.BE



Buitenhoek

Angle extérieur



BESTELNUMMER N° DE COMMANDE	Breedte x Hoogte Largeur x Hauteur	
<b>LHD8926HF</b>	20 x 10 mm	1/10
<b>LHD8626HF</b>	20 x 20 mm	1/10
<b>LHD8636HF</b>	40 x 20 mm	1/10
<b>LHD8646HF</b>	40 x 40 mm	1/10

Binnenhoek

Angle intérieur



BESTELNUMMER N° DE COMMANDE	Breedte x Hoogte Largeur x Hauteur	
<b>LHD8925HF</b>	20 x 10 mm	1/10
<b>LHD8625HF</b>	20 x 20 mm	1/10
<b>LHD8635HF</b>	40 x 20 mm	1/10
<b>LHD8645HF</b>	40 x 40 mm	1/10
<b>SAI160BEU</b>	160 mm	1/10

## MINI KANALEN LSOH GOULOTTES MINI LSOH

Vlakke hoek

Angle plat



BESTELNUMMER N° DE COMMANDE	Breedte x Hoogte Largeur x Hauteur	
LHD8923HF	20 x 10 mm	1/10
LHD8623HF	20 x 20 mm	1/10
LHD8633HF	40 x 20 mm	1/10
LHD8643HF	40 x 40 mm	1/10

T-stuk

Déviation-T



BESTELNUMMER N° DE COMMANDE	Breedte x Hoogte Largeur x Hauteur	
LHD8924HF	20 x 10 mm	1/10
LHD8624HF	20 x 20 mm	1/10
LHD8634HF	40 x 20 mm	1/10
LHD8644HF	40 x 40 mm	1/10

## WANDKANALEN INWAY GOULOTTES INWAY

Wandkanalen PVC White  
Goulotte PVC White



BESTELNUMMER N° DE COMMANDE	Breedte x Hoogte Largeur x Hauteur	Lengte Longueur	
<b>IW10054B</b>	100 x 54 mm	2m	12 m
<b>IW10054BEK</b>	100 x 54 mm	1,3m*	7,8 m

RAL9003  
Deksel inbegrepen  
Couvercle inclus  
Op aanvraag !  
Sur demande !



Wandkanalen PVC - Black  
Goulotte PVC - Black

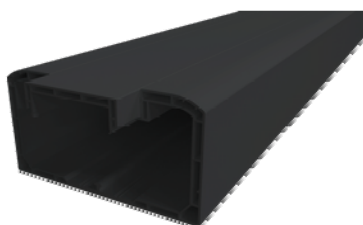

BESTELNUMMER N° DE COMMANDE	Breedte x Hoogte Largeur x Hauteur	Lengte Longueur	
<b>IW10054Black</b>	100 x 54 mm	2m	12 m
<b>IW10054EKBlack</b>	100 x 54 mm	1,3m*	7,8 m

RAL9004  
Deksel inbegrepen  
Couvercle inclus  
Op aanvraag !  
Dur demande !



Wandkanalen LSOH  
Goulotte LSOH

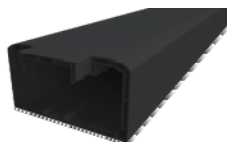
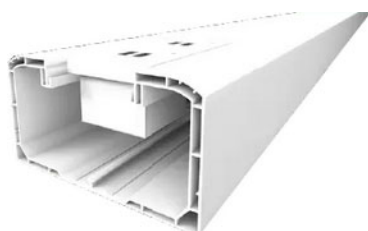

BESTELNUMMER N° DE COMMANDE	Breedte x Hoogte Largeur x Hauteur	RAL	
<b>IW10054BHL</b>	100 x 54 mm	RAL9003	12 m
<b>IW10054LHBlack</b>	100 x 54 mm	RAL9004	12 m

Deksel inbegrepen  
Lengte : 2 meter  
Couvercle inclus  
Longueur : 2 mètres



# WANDKANALEN INWAY GOULOTTES INWAY

Toebehoren Wandkanalen INWAY

Accessoires Goulottes Murales INWAY



BESTELNUMMER N° DE COMMANDE	Omschrijving	Description	
IWAE10054B	Verstelbare buitenhoek	Angle extérieur flexible	6
IWAE10054Black	Verstelbare buitenhoek	Angle extérieur flexible	6
IWAI10054B	Verstelbare binnenhoek	Angle intérieur flexible	6
IWAI10054Black	Verstelbare binnenhoek	Angle intérieur flexible	6
IWAP10054B	Vlakke hoek	Angle plat	8
IWAP10054Black	Vlakke hoek	Angle plat	8
IWGT10054B	T-stuk	Déviation-T	6
IWGT10054Black	T-stuk	Déviation-T	6
IWGU100	Verbinding voor basis en deksel	Joint pour base et couvercle	100
IWGU100Black	Verbinding voor basis en deksel	Joint pour base et couvercle	100
IWS10040B	Scheidings	Séparateur	8
IWS10040Black	Scheidings	Séparateur	8
IWTT10054B	Eindstuk	Embout	12
IWTT10054Black	Eindstuk	Embout	12



## WANDKANALEN GOULOTTES MURALES

Wandkanaal SYS45 RAPID

Goulottes SYS45 RAPID



BESTELNUMMER N° DE COMMANDE	Breedte x Hoogte Largeur x Hauteur	RAL	
<b>SYS751</b>	75 x 50 mm	RAL 9010	24 m
<b>SYS1252</b>	125 x 50 mm	RAL 9010	16 m
<b>SYS1603</b>	160 x 50 mm	RAL 9010	12 m
<b>SYS1051</b>	100 x 50 mm	RAL 9010	16 m

Deksel inbegrepen

Lengte : 2 meter

Couvercle inclus

Longueur : 2 mètres

LIJST VAN DE TOEBEHOREN - ZIE WWW.GSV.BE

LISTE DES ACCESSOIRES - SUR WWW.GSV.BE

Deksels voor wandkanalen SYS45 RAPID

Couvercles pour goulottes SYS45 RAPID



BESTELNUMMER N° DE COMMANDE	Afm. Dim.	RAL	
<b>SCO45</b>	45 mm	RAL 9010	64 m

Lengte / Longueur : 2 mètres

Verbindingsstuk basis

Joint de fond



BESTELNUMMER N° DE COMMANDE	
<b>SGACBEU</b>	1/50



## WANDKANALEN GOULOTTES MURALES

Dekselverbinder  
Joint de couvercle



BESTELNUMMER N° DE COMMANDE	
SGCOBEU	1/20

Buitenhoek  
Angle extérieur



BESTELNUMMER N° DE COMMANDE	Afm. Dim.	
LD075EBEU	75 mm	1/16
LD105EBEU	100 mm	1/15
LD125EBEU	125 mm	1/10
SAE160BEU	160 mm	1/4

Binnenhoek  
Angle intérieur



BESTELNUMMER N° DE COMMANDE	Afm. Dim.	
LD075IBEU	75 mm	1/16
LD125IBEU	125 mm	1/10
SAI160BEU	160 mm	1/10

Vlakke hoek  
Angle plat



BESTELNUMMER N° DE COMMANDE	Afm. Dim.	
LD075LBEU	75 mm	1/20
LD105LBEU	100 mm	1/10
LD125LBEU	125 mm	1/8
SAP160BEU	160 mm	1/10

## WANDKANALEN GOULOTTES MURALES

T-stuk  
Déviation-T



BESTELNUMMER N° DE COMMANDE	Afm. Dim.	
LHD8924HF	20 x 10 mm	1/10
LHD8624HF	20 x 20 mm	1/10
LHD8634HF	40 x 20 mm	1/10
LHD8644HF	40 x 40 mm	1/10
LD075TBEU	75 mm	1/12
LD105TBEU	100 mm	1/15
LD125TBEU	125 mm	1/10

Eindstuk  
Embout



BESTELNUMMER N° DE COMMANDE	Afm. Dim.	
LD075ABEU	75 mm	1/20
STT125BEU	125 mm	1/10
STT160BEU	160 mm	1/10

## KABELGELEIDERS CONDUITS POUR CABLES

Spiralen Transparant  
Spirales Transparent



BESTELNUMMER N° DE COMMANDE	∅	
CP03	3 mm	50 m
CP06	6 mm	25 m
CP08	8 mm	25 m
CP10	10 mm	25 m
CP12	12 mm	25 m
CP20	20 mm	10 m

Spiralen Zwart  
Spirales Noir



BESTELNUMMER N° DE COMMANDE	∅	
CPN03	3 mm	50 m
CPN06	6 mm	25 m
CPN08	8 mm	25 m
CPN10	10 mm	25 m
CPN12	12 mm	25 m
CPN20	20 mm	10 m

Polyester beschermkous  
Gaine de protection polyestère



BESTELNUMMER N° DE COMMANDE	∅	
Guest05	5-10 mm	200 m
Guest10	10-18 mm	200 m
Guest20	20-30 mm	100 m
Guest30	30-45 mm	100 m
Guest50	50-75 mm	50 m

Mini bedradingskanalen  
Canaux de câblage mini

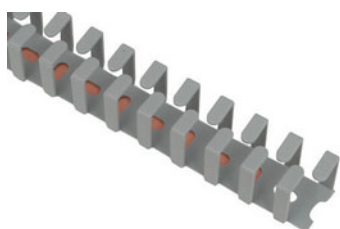

BESTELNUMMER N° DE COMMANDE	Afm. Dim.	
FLX10	13 x 15 mm	25 m
FLX20	20 x 24 mm	25 m
FLX30	29 x 33 mm	25 m
FLX40	40 x 44 mm	25 m

Lengte / longueur : 500 mm

## AARDINGSMATERIAAL MATERIEL DE MISE A LA TERRE

Aardstaven kruisvorm met vlag

Piquets de terre en forme de croix avec drapeau



BESTELNUMMER N° DE COMMANDE	Afm. Dim.	Lengte Longueur	
AML511		1,0 m	5
AML512		1,5 m	5
AML513		2,0 m	5
AML514		2,5 m	5
AML515		3,0 m	5
AML512-E	1500 mm*		5

50 x 50 x 3 mm

Warm verzinkt / Galvanisé chaud

\* Zonder vlag / Sans drapeau

Klemschroeven voor aardstaaf

Boulons de serrage pour piquet de terre

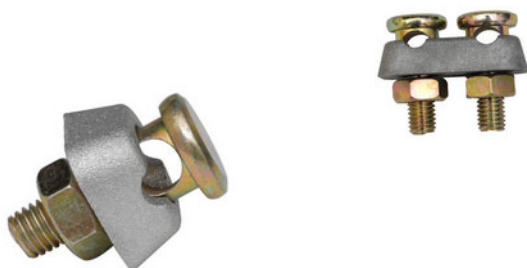

BESTELNUMMER N° DE COMMANDE	Omschrijving	Description	
AMM1	Enkel	Simple	10
AMM2	Dubbel	Double	10

Bandaardingsklemmen

Bandes pour mise à la terre



BESTELNUMMER N° DE COMMANDE	Afm. Dim.	
AM370	12 cm	10/300
AM371	19 cm	10/300
AM374	42 cm	10/200
AM376	58 cm	10/100

Voor / Pour : 1 x 2,5 mm<sup>2</sup> à 2 x 6 mm<sup>2</sup>

Vernikkelde klem + schroef. Inox band.

Clame + écrous nickelées. Bande en inox.

\* Dubbel Schroef / Double vis

## AARDINGSMATERIAAL MATERIEL DE MISE A LA TERRE

Moerklemmen (Splitklemmen)

Connecteurs de dérivation



BESTELNUMMER N° DE COMMANDE	∅	
AM9200026	6 - 10 mm <sup>2</sup>	100
AM9200027	16 mm <sup>2</sup>	100
AM9200028	25 mm <sup>2</sup>	100
AM9200029	35 mm <sup>2</sup>	50
AM9200030	50 mm <sup>2</sup>	50

Messing vernikkeld  
Laiton nickelé

Aardstaven met kopermantel om te vijzen - 30 μ

Piquets manteau de cuivre pour visser - 30 μ



BESTELNUMMER N° DE COMMANDE	∅ IN	∅	Lengte Longueur	
AM117	14,2 mm	16 mm	1500 mm	10 / 500
AM118	14,2 mm	16 mm	2000 mm	10
AM127	16,0 mm	18 mm	1500 mm	10
AM128	16,0 mm	18 mm	2000 mm	10

Aardstaven met kopermantel om te vijzen - 100 μ

Piquets manteau de cuivre pour visser - 100 μ



BESTELNUMMER N° DE COMMANDE	∅ IN	∅	Lengte Longueur	
AM117-100	14,2 mm	16 mm	1500 mm	10 / 500
AM118-100	14,2 mm	16 mm	2000 mm	10
AM127-100	16,0 mm	18 mm	1500 mm	10
AM128-100	16,0 mm	18 mm	2000 mm	10

\* Op aanvraag / Sur demande

Aardstaven met kopermantel om te vijzen - 250 μ\*

Piquets manteau de cuivre pour visser - 250 μ\*



BESTELNUMMER N° DE COMMANDE	∅ IN	∅	Lengte Longueur	
AM117-250	14,2 mm	16mm	1500 mm	*
AM118-250	14,2 mm	16mm	2000 mm	*

\* Op aanvraag / Sur demande

## AARDINGSMATERIAAL MATERIEL DE MISE A LA TERRE

Moffen om te vijzen  
Manchons à visser



BESTELNUMMER N° DE COMMANDE	∅	
<b>AMM116</b>	16 mm	1/130
<b>AMM126</b>	18 mm	1/120
<b>AMMB116</b>	16 mm	1/240

Messing / Laiton

Aardstaven met kopermantel conisch - 30 μ  
Piquets manteau cuivre conique - 30 μ



BESTELNUMMER N° DE COMMANDE	∅	Lengte Longueur	
<b>AM114SS</b>	14,0 mm	1500 mm	10 / 500

Moffen conisch  
Manchons cône



BESTELNUMMER N° DE COMMANDE	∅	
<b>AMM116-C</b>	14 mm	1/100

Messing / Laiton

Klemmen  
Clames



BESTELNUMMER N° DE COMMANDE	∅	
<b>AMS116</b>	16 mm	1/250
<b>AMS126</b>	18 mm	1/100
<b>AMSB116</b>	16 mm	1/250

1 Messing / Laiton

## AARDINGSMATERIAAL MATERIEL DE MISE A LA TERRE

Handslagijzers  
Têtes de frappe



BESTELNUMMER N° DE COMMANDE	∅	
AMT116	16 mm	1/100
AMT126	18 mm	1/100

Handslagbouten  
Boulons de frappe



BESTELNUMMER N° DE COMMANDE	∅	
AMDS16	16 mm	1/100
AMDS18	18 mm	1/100

Aardingsonderbrekers + rail voor dito A  
Coupures de terre + rail pour dito A



BESTELNUMMER N° DE COMMANDE	
AM0301	25

Aardingsonderbrekers + rail voor dito B  
Coupures de terre + rail pour dito B



BESTELNUMMER N° DE COMMANDE	
AM0303	20

## AARDINGSMATERIAAL MATERIEL DE MISE A LA TERRE

Aardingsonderbrekers + rail voor dito C  
Coupures de terre + rail pour dito C



BESTELNUMMER N° DE COMMANDE	
AMK0305	14

Klauw  
Griffe



BESTELNUMMER N° DE COMMANDE	
AMK0310	100

Klauwklemmen  
Borniers à griffes



BESTELNUMMER N° DE COMMANDE	Specificiteit Spécificités	∅	
AMCC1016	*1	< 16 mm <sup>2</sup>	1
AMCC2550	*1	< 50 mm <sup>2</sup>	1
AMCC-D-1016	*2	< 16 mm <sup>2</sup>	1
AMCC-D-2550	*2	< 50 mm <sup>2</sup>	1

\*1 Enkel / Simple

\*2 Dubbel / Double

Design radiator klemmen  
Clame de terre pour écrou de radiateur



BESTELNUMMER N° DE COMMANDE	Afm. Dim.	GRONDST	MATIERE	
9260030	30 mm	Messing -Vernikkelc	Laiton Nickelé	5



# Stekkers Fiches

C312B

C312B



BESTELNUMMER N° DE COMMANDE	
<b>C312B</b>	1/24

10/16A - IP44  
Normes  
250V - Norm7 - VD

C313B

C313B



BESTELNUMMER N° DE COMMANDE	
<b>C313B</b>	1/24

Norm 7 IP44 VDE  
10/16 A  
250 V

C310W

C310B



BESTELNUMMER N° DE COMMANDE	Specificiteit Spécificités	
<b>C310B</b>	Black	1/25
<b>C310W</b>	White	1/25

IP20 - 250V - IEC60884 - DIN49441  
10/16 A  
Rubber / Caoutchouc

C311W

C311B



BESTELNUMMER N° DE COMMANDE	Specificiteit Spécificités	
<b>C311B</b>	Black	1/24
<b>C311W</b>	White	1/24

IP20 - 250V - IEC60884 - DIN49441  
IP20 - 250V - IEC60884 - DIN49441  
10/16 A  
Rubber / Caoutchouc

C404

C404



BESTELNUMMER N° DE COMMANDE	
<b>C404</b>	1/40

250V - Norm7 - VDE ; 10/16A - IP44

C300W

C300B



BESTELNUMMER N° DE COMMANDE	Specificiteit Spécificités	
<b>C300B</b>	Black	1/25
<b>C300W</b>	White	1/25

IP20 - 250V - IEC60884 - DIN49441  
16 A  
PVC

Stekker

Fiches plates



BESTELNUMMER N° DE COMMANDE	Specificiteit Spécificités	
<b>C320B</b>	Black	1/48
<b>C320W</b>	White	1/48
<b>C321B</b>	Black	1/48
<b>C321W</b>	White	1/48

320\*      321\*  
Mannelijk      Vrouwelijk  
Mâle      Femelle  
PVC

10A - 250V - IEC 60884 - UNE ESC10a

# CEE STEKKER PRISES CEE

Stekkers

Fiches mâles



BESTELNUMMER N° DE COMMANDE	A	Polen Poles	Spanning Tension	
9316-4	16 A	3	230 V	10
9416-4	16 A	4	400 V	10
9516-4	16 A	5	400 V	10
9332-4	32 A	3	230 V	10
9432-4	32 A	4	400 V	10
9532-4	32 A	5	400 V	10



Koppelstekkers

Fiches femelles



BESTELNUMMER N° DE COMMANDE	A	Polen Poles	Spanning Tension	
9316-3	16 A	3	230 V	10
9416-3	16 A	4	400 V	10
9516-3	16 A	5	380 V	10
9332-3	32 A	3	230 V	10
9432-3	32 A	4	400 V	10
9532-3	32 A	5	400 V	10



Wandozen

Prises murales



BESTELNUMMER N° DE COMMANDE	A	Polen Poles	Spanning Tension	
9316-2	16 A	3	230 V	10
9416-2	16 A	4	400 V	5
9516-2	16 A	5	400 V	5
9332-2	32 A	3	230 V	5
9432-2	32 A	4	400 V	5
9532-2	32 A	5	400 V	5



# CEE STEKKER PRISES CEE

Inbouwdozen

Prises à encastrer



BESTELNUMMER N° DE COMMANDE	A	Polen Poles	Spanning Tension	
9316-1	16 A	3	230 V	10
9416-1	16 A	4	400 V	10
9516-1	16 A	5	400 V	10
9332-1	32 A	3	230 V	10
9432-1	32 A	4	400 V	10
9532-1	32 A	5	400 V	10



## CEE STEKKERS - IP 67 PRISES CEE - IP 67

Stekkers

Fiches mâles



BESTELNUMMER N° DE COMMANDE	A	Polen Poles	Spanning Tension	
679316-4	16 A	3	250 V	10
679416-4	16 A	4	415 V	10
679516-4	16 A	5	415 V	10
679332-4	32 A	3	250 V	10
679432-4	32 A	4	415 V	10
679532-4	32 A	5	415 V	10
679363-8	63 A	3	250 V	1
679463-8	63 A	4	415 V	1
679563-8	63 A	5	415 V	1

IP67



Koppelstekkers

Fiches femelles



BESTELNUMMER N° DE COMMANDE	A	Polen Poles	Spanning Tension	
679316-3	16 A	3	250 V	10
679416-3	16 A	4	415 V	10
679516-3	16 A	5	415 V	10
679332-3	32 A	3	250 V	10
679432-3	32 A	4	415 V	10
679532-3	32 A	5	415 V	10
679363-7	63 A	3	250 V	1
679463-7	63 A	4	415 V	1
679563-7	63 A	5	415 V	1

IP67



Wanddozen

Prises murales



BESTELNUMMER N° DE COMMANDE	A	Polen Poles	Spanning Tension	
679316-2	16 A	3	250 V	10
679416-2	16 A	4	415 V	10
679516-2	16 A	5	415 V	10
679332-2	32 A	3	250 V	10

IP67



## CEE STEKKERS - IP 67 PRISES CEE - IP 67

Wanddozen

Prises murales



BESTELNUMMER N° DE COMMANDE	A	Polen Poles	Spanning Tension	
679432-2	32 A	4	415 V	10
679532-2	32 A	5	415 V	10
679363-6	63 A	3	250 V	1
679463-6	63 A	4	415 V	1
679563-6	63 A	5	415 V	1

IP67



Inbouwdozen

Prises à encastrer



BESTELNUMMER N° DE COMMANDE	A	Polen Poles	Spanning Tension	
679316-1	16 A	3	250 V	10
679416-1	16 A	4	415 V	10
679516-1	16 A	5	415 V	10
679332-1	32 A	3	250 V	10
679432-1	32 A	4	415 V	10
679532-1	32 A	5	415 V	8
679363-5	63 A	3	250 V	2
679463-5	63 A	4	415 V	2
679563-5	63 A	5	415 V	2

IP67



## VERLENGSNOER EN STOPCONTACTEN ENROULEUR ET PRISES

VERLENGSNOER RUBBER  
RALLONGE CAOUTCHOUC



BESTELNUMMER N° DE COMMANDE	Lengte Longueur	
MFVS10	10m	1
MFVS15	15m	1
MFVS20	20m	1
MFVS25	25m	1
MFVS30	30m	1
MFVS40	40m	1
MFVS50	50m	1

H07RN-F, 3G2.5, IP44, 16A, 250V

PROFESSIONELE KABELHASPEL  
ENROULEUR PROFESSIONNEL



BESTELNUMMER N° DE COMMANDE	Lengte Longueur	
MFR253G25	25m	1
MFR403G25	40m	1

4 prises/stopcontacten, IP44, H07RN-F, 25m, 3G2.5, 16A, 250V, 3600W

PROFESSIONELE MEERVOUDIGE STEKKERBLOK  
SOCLE MULTIPRISES PROFESSIONNEL



BESTELNUMMER N° DE COMMANDE	
MFM46	1

4 prises/stopcontacten, IP44, H07RN-F, 6m, 3G2.5, 16A, 250V

INBOUW STOPCONTACT MET KLAPDEKSEL  
PRISE A CLAPET A ENCASTRER

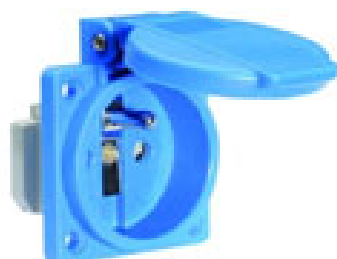

BESTELNUMMER N° DE COMMANDE	
MFPS17	1

blauw, penoording, IP44, 16A, 250V  
bleu, broche de terre

## VERLENGSNOER EN STOPCONTACTEN ENROULEUR ET PRISES

DOOS VOOR STEKKERVERBINDING, IP44  
BOÎTIER POUR RACCORD DE PRISES, IP44



BESTELNUMMER  
N° DE COMMANDE

MFBOX01



1

CE, RoHS, REACH, PAHS



W4-16



BESTELNUMMER N° DE COMMANDE	∅	
<b>W4-16</b>	4 - 16 mm <sup>2</sup>	1/12

Met haakkling voor verwijdering van de isolatie.  
Avec lame spéciale pour écarter l'isolation.

W8-28



BESTELNUMMER N° DE COMMANDE	∅	
<b>W8-27</b>	8 - 28 mm <sup>2</sup>	1/12

Met haakkling voor verwijdering van de isolatie.  
Avec lame spéciale pour écarter l'isolation.

W50



BESTELNUMMER N° DE COMMANDE	∅ IN	∅	
<b>W50</b>	35 - 50	35 - 50 mm <sup>2</sup>	1/12

W1000



BESTELNUMMER N° DE COMMANDE	
<b>W1000</b>	1/12

Met haakkling voor verwijdering van de isolatie.  
Avec lame spéciale pour écarter l'isolation.

## WBLI28H4



BESTELNUMMER N° DE COMMANDE	∅	
<b>WBLI28H4</b>	4 - 28 mm	1/12

Met haakkling voor verwijdering van de isolatie.  
Avec lame spéciale pour écarter l'isolation.

## WBLIS428



BESTELNUMMER N° DE COMMANDE	∅	
<b>WBLIS428</b>	4 - 28 mm	1/12

Gemoderniseerde versie van de BLI28H. Met inklapbaar mes.  
Version modernisée du BLI28H. Avec lame retractable,

## W10



BESTELNUMMER N° DE COMMANDE	
<b>W10</b>	1

Vervangmesje voor 16 - 27 - 50 - BLI28H  
Lame de réchange pour 16 - 27 - 50 - BLI28H

## W10.1



BESTELNUMMER N° DE COMMANDE	
<b>W10.1</b>	1

Vervangmesje voor BLIS428  
Lame de réchange pour BLIS428

W100



BESTELNUMMER N° DE COMMANDE	
<b>W100</b>	1/12

Ontmantelmes + striptang.  
Couteau à démanteler + dénuder.

WBLI13



BESTELNUMMER N° DE COMMANDE	∅	
<b>WBLI13</b>	6 - 13 mm	1/12

Ontmantelingsmes ronde kabel van 3 x 1,5 mm tot 5 x 2,5 mm.

Buitendiameter : 6 tot 13 mm.

Couteau à démanteler pour câbles ronds de 3 x 1,5 mm<sup>2</sup> à 5 x 2,5 mm.

Diamètre extérieur : 6 à 13 mm.

W16



BESTELNUMMER N° DE COMMANDE	∅ IN	∅	
<b>W16</b>	4 - 16	8 - 13 mm <sup>2</sup>	1/12

Quadro Ontmantelingsmes, haakmes inklapbaar, strippen 0,5 tot 6mm<sup>2</sup>

Quadro Couteau a demanteler, lame en crochet retractable, dénudeur

0,5 jusqu'au 6mm<sup>2</sup>

W30



BESTELNUMMER N° DE COMMANDE	∅	
<b>W30</b>	4 - 10 mm	1/12

Data - Strip Ontmantelingsmes voor data kabel, strippen 0,2 - 0,8mm<sup>2</sup>

Data Strip - Couteau à démanteler pour câble data, coupe-fil jusqu'à ∅ 8 mm, dénudeur 0,2 - 0,8 mm<sup>2</sup>

W25



BESTELNUMMER N° DE COMMANDE	∅	
<b>W25</b>	25 mm	1/6

Ontmantelingsmes voor grondkabel, Ø = 25mm (zowel dwars als in de lengte), tot manteldikte 5mm  
 Couteau à demanteler pour cable de sol, Ø = 25 mm (circulaire et longitudinal), jusqu'à 5mm d'épaisseur

Striptang SUPER

Pince à dénuder SUPER



BESTELNUMMER N° DE COMMANDE	∅	
<b>WBLI5</b>	0,2-6 mm	1/6

Tang DUO CRIMP

Pince DUO CRIMP



BESTELNUMMER N° DE COMMANDE	∅	
<b>W300</b>	0,5-6 mm	1/6

MULTI-STRIPPER

MULTI-STRIPPER



BESTELNUMMER N° DE COMMANDE	∅	
<b>W400</b>	8-13 mm	1/6

# GEREEDSCHAP OUTILLAGE

MULTI-STRIPPER PLUS  
MULTI-STRIPPER PLUS



BESTELNUMMER N° DE COMMANDE	∅	
<b>W500</b>	0,5-6 mm	1/12

Strippen + knippen + krimpen.  
Dénuder + couper +sertir.

Striptangen SOLAR  
Pinces à dénuder SOLAR



BESTELNUMMER N° DE COMMANDE	∅	
<b>WBLI3SOLAR</b>	1,5 - 6 mm <sup>2</sup>	1
<b>WBLI7SOLAR</b>	1,5 - 6 mm <sup>2</sup>	1

Speciaal voor zonne-energie techniek.  
Spécialement pour le technique énergie solaire.

Krimptangen voor geïsoleerde kabelschoenen  
Pinces à sertir pour souliers de cable isolés



BESTELNUMMER N° DE COMMANDE	∅	
<b>DHCR15</b>	1,5 - 4 mm <sup>2</sup>	1

Krimptang voor niet-geïsoleerde kabelschoenen  
Pince à sertir pour souliers de cable non-isolés



BESTELNUMMER N° DE COMMANDE	∅	
<b>DHC95</b>	10 - 95 mm <sup>2</sup>	1

## GEREEDSCHAP OUTILLAGE

Buistang Voor het knippen van PVC-buizen 16 mm en 20 mm  
Pince pour couper tubes Pour couper tubes en PVC de 16 mm et



BESTELNUMMER N° DE COMMANDE	
KT3204	1

Voor het knippen van PVC-buizen  
16 mm en 20 mm.  
Pour couper tubes en PVC de  
16 mm et 20 mm.

Reserve onderbasis tang 3204  
Base de rechange pour pince 3204



BESTELNUMMER N° DE COMMANDE	
KT3002-3204	1

Reservemesje tangen 3204 en 3704  
Lame de rechange pour pinces 3204 et 3704



BESTELNUMMER N° DE COMMANDE	
KT3001	1

Flextang Voorbekabelde Ribbuis  
Pince Pour Tube Flex



BESTELNUMMER N° DE COMMANDE	∅	
KT3704	16 - 20 mm (21 mm)	1

Voor ontmanteling van voorbekabelde ribbel-buis.  
Pour démanteler tubes annelés pré-câblés.  
16 - 20 mm (21 mm)

## GEREEDSCHAP OUTILLAGE

Onderbasis Voor Tang 3704  
Base Pour Pince 3704



BESTELNUMMER N° DE COMMANDE	
KT3002-3704	1

Reservemesje tangen 3204 en 3704  
Lame de rechange pour pinces 3204 et 3704



BESTELNUMMER N° DE COMMANDE	
KT3001	1

Kanaaltang  
Pince de canal



BESTELNUMMER N° DE COMMANDE	
KT3604	1

Trekveren Spiraal ø 5,5 mm, versterkt  
Tire-fils Spirale ø 5,5 mm, renforcé



BESTELNUMMER N° DE COMMANDE	Lengte Longueur	
305505	5 m	1/20
305510	10 m	1/15
305515	15 m	1/10
305520	20 m	1/8
305525	25 m	1/6
305530	30 m	1/5

## Plat



BESTELNUMMER N° DE COMMANDE	Lengte Longueur	
11405	5 m	1/10
11410	10 m	1/10
11415	15 m	1/10
11420	20 m	1/10
11425	25 m	1/10
11430	30 m	1/10

## Nylon dia. 4 mm



BESTELNUMMER N° DE COMMANDE	Lengte Longueur	
11605	5 m	1/25
11610	10 m	1/20
11615	15 m	1/12
11620	20 m	1/10
11625	25 m	1/8
11630	30 m	1/6

## Glasfiber Fibre de verre



BESTELNUMMER N° DE COMMANDE	Lengte Longueur	PIC
37000	30 m	A
37010	50 m	A
37020	60 m	A
37030	80 m	A
37040	100 m	A
37050	60 m	A
37060	100 m	A
37070	120 m	A
37080	150 m	A
37090	30 m	B
37100	50 m	C
37110	60 m	C
37120	80 m	C
37130	100 m	C
37140	60 m	C
37150	100 m	C

Op bestelling / sur commande





## GEREEDSCHAP OUTILLAGE

Glasfiber  
Fibre de verre



BESTELNUMMER N° DE COMMANDE	Lengte Longueur	PIC
37160	120 m	C
37170	150 m	C

Op bestelling / sur commande



Spirado



BESTELNUMMER N° DE COMMANDE	
Spirado	1

Spiratrek



BESTELNUMMER N° DE COMMANDE	
Spiratrek	1

Buigveren  
Ressorts à courber



BESTELNUMMER N° DE COMMANDE	ø	Lengte Longueur	
310816	16 mm	80 cm	1
310820	20 mm	80 cm	1
310825	25 mm	80 cm	1
311616	16 mm	160 cm	1
311620	20 mm	160 cm	1

Versterkte uitvoering.  
Staaldraad 2 x 2 mm.  
Exécution renforcée.  
Fil en acier 2 x 2 mm.

## GEREEDSCHAP OUTILLAGE

Buigveren

Ressorts à courber



BESTELNUMMER N° DE COMMANDE	∅	Lengte Longueur	
<b>311625</b>	25 mm	160 cm	1

Versterkte uitvoering.  
Staaldraad 2 x 2 mm.  
Exécution renforcée.  
Fil en acier 2 x 2 mm.

Fitting in thermoplast E27  
Soquet thermoplastique E27



Kelderverlichtingen  
Hublots



BESTELNUMMER N° DE COMMANDE	KLEUR	COULEUR	
755	Zwart	Noir	50 / 500



BESTELNUMMER N° DE COMMANDE	VERMOGEN PUISSANCE	
460	100 W	1/30
470	100 W	1/18
471	60 W	1/24

Voet : PVC  
Glas : Polycarbonaat / onbreekbaar.  
Pied : PVC  
Verre : Polycarbonate / incassable



## BEUGELS MET RUBBER COLLIERS ISOPHONIKES

Met Scharnier  
Avec Charnière



BESTELNUMMER N° DE COMMANDE	∅	
PC0015	11-15 mm	100
PC0018	15-19 mm	100
PC0022	21-23 mm	100
PC0028	26-28 mm	100
PC0035	32-35 mm	100
PC0042	40-43 mm	50
PC0048	48-51 mm	50
PC0054	51-56 mm	50
PC0060	57-60 mm	50
PC0064	62-65 mm	50

Snelmontage met rubber  
Fixation rapide avec caoutchouc

Met twee vijzen  
Avec deux vis



BESTELNUMMER N° DE COMMANDE	∅	
PC1075	75-80 mm	25
PC1090	87-92 mm	25
PC1100	99-105 mm	25
PC1110	107-112 mm	25
PC1115	113-118 mm	25
PC1125	125-130 mm	25
PC1133	132-137 mm	25
PC1140	138-142 mm	25
PC1150	148-152 mm	25
PC1160	159-166 mm	25

## METALEN KANALEN CHEMINS DE CÂBLE EN METAL

Metalen kanalen geperforeerd  
Chemins de câble perforés



BESTELNUMMER N° DE COMMANDE	Afm. Dim.	
<b>MT6075075</b>	60x75x0,75mm	24 m
<b>MT60100075</b>	60x100x0,75mm	18 m
<b>MT60100100</b>	60x100x1,00mm	18 m
<b>MT60200075</b>	60x200x0,75mm	18 m
<b>MT60200100</b>	60x200x1,00mm	12 m
<b>MT60300075</b>	60x300x0,75mm	12 m
<b>MT60300100</b>	60x300x1,00mm	12 m

LIJST VAN DE TOEBEHOREN - ZIE WWW.GSV.BE  
LISTE DES ACCESSOIRES - SUR WWW.GSV.BE  
Lengte/Longueur : 3 m

Niet Geperforeerd Kabelgoot  
Chemin De Cable Non Perforé



BESTELNUMMER N° DE COMMANDE	Afm. Dim.	
<b>MTN60100075</b>	60x100x0,75mm	18 m
<b>MTN60100100</b>	60x100x1,00mm	18 m
<b>MTN60200075</b>	60x200x0,75mm	12 m
<b>MTN60200100</b>	60x200x1,00mm	12 m
<b>MTN60300075</b>	60x300x0,75mm	12 m
<b>MTN60300100</b>	60x300x1,00mm	12 m

LIJST VAN DE TOEBEHOREN - ZIE WWW.GSV.BE  
LISTE DES ACCESSOIRES - SUR WWW.GSV.BE  
Lengte/Longueur : 3 m

C - Beugel voor plafond  
Fixation en C pour plafond

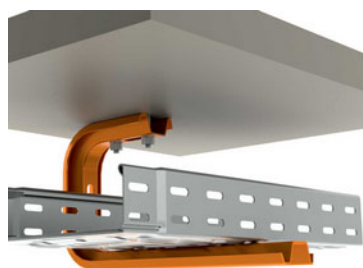

BESTELNUMMER N° DE COMMANDE	Afm. Dim.	
<b>MTCTS100</b>	161 x 172 mm	12
<b>MTCTS200</b>	261 x 172 mm	12
<b>MTCTS300</b>	361 x 172 mm	6

# METALEN KANALEN CHEMINS DE CÂBLE EN METAL

L - beugel voor Wand  
Fixation en L Murale



BESTELNUMMER N° DE COMMANDE	Afm. Dim.	
<b>MTLTS100</b>	145 x 150 mm	20
<b>MTLTS150</b>	195 x 150 mm	20
<b>MTLTS200</b>	245 x 150 mm	20
<b>MTLTS300</b>	345 x 150 mm	20

Draadgoten Easy Connect  
Chemins de câble Easy Connect

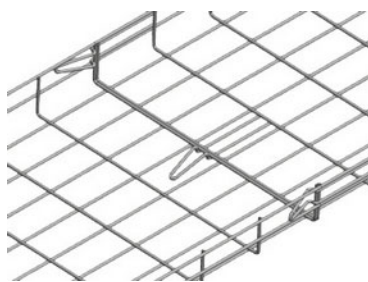

BESTELNUMMER N° DE COMMANDE	Afm. Dim.	
<b>EC60060EZ</b>	60x060mm	36 / 1008 m
<b>EC60100EZ</b>	60x100mm	24 / 924 m
<b>EC60150EZ</b>	60x150mm	18 / 630 m
<b>EC60200EZ</b>	60x200mm	12/24/498 m
<b>EC60300EZ</b>	60x300mm	12 / 324 m
<b>EC60400EZ</b>	60x400mm	12 / 240 m
<b>EC60500EZ</b>	60x500mm	6 / 204 m
<b>EC60600EZ</b>	60x600mm	6 / 180 m

Standaard uitvoering / Finition standard  
Quick Connection: met snelkoppeling / avec connexion rapide  
LIJST VAN DE TOEBEHOREN - ZIE WWW.GSV.BE  
LISTE DES ACCESSOIRES - SUR WWW.GSV.BE  
Beschikbaar in RVS / Hot Deep Galvanised  
Disponible en Inox /Hot Deep Galvanised



C - Beugel voor plafond  
Fixation en C pour plafond



BESTELNUMMER N° DE COMMANDE	Afm. Dim.	
<b>SOPC10SG</b>	180x115x215mm	8
<b>SOPC15SG</b>	180x115x265mm	8
<b>SOPC20SG</b>	180x115x315mm	8
<b>SOPC30SG</b>	180x115x415mm	8



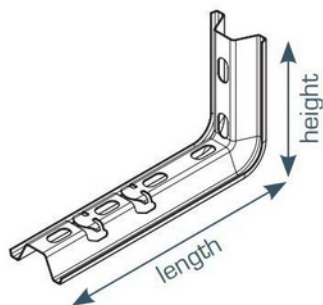

# METALEN KANALEN CHEMINS DE CÂBLE EN METAL

L - beugel voor Wand  
Fixation en L Murale

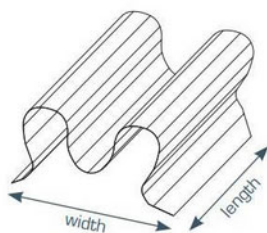

Snel Verbinder  
Connecteur Rapide



BESTELNUMMER N° DE COMMANDE	Afm. Dim.	
SOC10SG	115x215mm	10
SOC15SG	115x265mm	10
SOC20SG	115x315mm	10
SOC30SG	115x415mm	10



BESTELNUMMER N° DE COMMANDE	Afm. Dim.	
MCLIC	13x23mm	100

# Index

## 0

010TARM016 30  
 010TARM020 30  
 010TARM025 30  
 010TARM032 30  
 010TARM040 30  
 010TARM050 30  
 010TARM063 30  
 020CARM016 30  
 020CARM020 30  
 020CARM025 30  
 020CARM032 30  
 020CARM040 30  
 020CARM050 30  
 020CARM063 30  
 020MARM016 31  
 020MARM020 31  
 020MARM025 31  
 020MARM032 31  
 020MARM040 31  
 020MARM050 31  
 020MARM063 31  
 031G ..... 44  
 031T ..... 44  
 040CDTM254 16  
 040CDTM255 16  
 040CDTM256 16  
 040CDTM257 16  
 040CDTM258 16  
 060TARMi20 30  
 060TARMi25 30  
 060TARMi32 30  
 060TARMi40 30  
 060TARMi50 30  
 061CARMi20 31  
 061CARMi25 31  
 061CARMi32 31  
 061CARMi40 31  
 061CARMi50 31  
 061MACMI20 31  
 061MACMI32 31  
 061MACMI40 31  
 061MACMI50 31  
 061MARMi25 31

## 1

10012 ..... 65  
 108 ..... 43  
 11405 ..... 128  
 11410 ..... 128  
 11415 ..... 128  
 11420 ..... 128  
 11425 ..... 128  
 11430 ..... 128  
 11605 ..... 128  
 11610 ..... 128  
 11615 ..... 128  
 11620 ..... 128  
 11625 ..... 128  
 11630 ..... 128

## 2

2012 ..... 70  
 2014 ..... 70  
 2016 ..... 70  
 2035 ..... 43  
 2036 ..... 43  
 2036 Black ... 33  
 2036 D ..... 44  
 2037 ..... 43  
 2037 Black ... 33

## 2

2037 D ..... 44  
 2038 ..... 43  
 2039 ..... 43  
 204 ..... 43  
 204 Black .... 33  
 204 D ..... 44  
 204 White .... 33  
 20436 ..... 44  
 2047 ..... 46  
 2048 ..... 46  
 2050 ..... 47  
 2051 ..... 47  
 208 ..... 43  
 208 Black .... 33  
 209 ..... 43  
 20BLI ..... 96  
 210 ..... 43  
 211 ..... 43  
 211 D ..... 44  
 219B ..... 9  
 220A ..... 8  
 220AM ..... 8  
 220B ..... 9  
 222A ..... 8  
 222AM ..... 8  
 222B ..... 9  
 223A ..... 8  
 223AM ..... 8  
 223ATA ..... 8  
 223ATAM ..... 8  
 223B ..... 9  
 223BTA ..... 9  
 223LTATR .... 11  
 224A ..... 8  
 224AM ..... 8  
 224B ..... 9  
 224LTR ..... 11  
 226B ..... 9  
 250001 ..... 63  
 250002 ..... 63  
 250005 ..... 63  
 250-11AM .... 21  
 250-5AM ..... 21  
 250-9AM ..... 21  
 250-9B ..... 21  
 251001 ..... 64  
 251001C ..... 64  
 251002 ..... 64  
 251002C ..... 64  
 273MF ..... 21  
 2761 ..... 67  
 28.41 ..... 11  
 28.43 ..... 11  
 28.43-PLEXI . 11  
 28.51 ..... 11  
 28.53 ..... 12  
 28.61 ..... 11

## 3

3004-18 ..... 59  
 3005-18 ..... 59  
 3006-18 ..... 59  
 300620W ..... 60  
 3007-18 ..... 59  
 3007-18Black 34, 59  
 300720W ..... 60  
 3008-20 ..... 59  
 3009-20 ..... 59  
 3010-35 ..... 59  
 3011-35 ..... 59

## 3

3012-35 ..... 59  
 3014-40 ..... 59  
 3016-40 ..... 59  
 3018-40 ..... 59  
 3020-40 ..... 59  
 305505 ..... 127  
 305510 ..... 127  
 305515 ..... 127  
 305520 ..... 127  
 305525 ..... 127  
 305530 ..... 127  
 310816 ..... 129  
 310820 ..... 129  
 310825 ..... 129  
 311616 ..... 129  
 311620 ..... 129  
 311625 ..... 130  
 316 ..... 19  
 318 ..... 19  
 350001 ..... 64  
 350002 ..... 64  
 37000 ..... 128  
 37010 ..... 128  
 37020 ..... 128  
 37030 ..... 128  
 37040 ..... 128  
 37050 ..... 128  
 37060 ..... 128  
 37070 ..... 128  
 37080 ..... 128  
 37090 ..... 128  
 37100 ..... 128  
 37110 ..... 128  
 37120 ..... 128  
 37130 ..... 128  
 37140 ..... 128  
 37150 ..... 128  
 37160 ..... 129  
 37170 ..... 129  
 397-3A ..... 17  
 397-5 ..... 17  
 398-5 ..... 17  
 399-5 ..... 17

## 4

411620 ..... 61  
 41E ..... 96  
 41G ..... 96  
 41I ..... 96  
 41L ..... 96  
 41S ..... 96  
 41T ..... 96  
 424 ..... 18  
 426 ..... 18  
 428 ..... 18  
 429 ..... 18  
 430 ..... 19  
 430V ..... 19  
 431 ..... 19  
 431V ..... 19  
 44E ..... 96  
 44G ..... 96  
 44I ..... 96  
 44L ..... 96  
 44T ..... 96  
 4570 ..... 71  
 460 ..... 131  
 470 ..... 131  
 471 ..... 131

## 5

501018 ..... 64  
 501025 ..... 64  
 501030 ..... 64  
 501040 ..... 64  
 50704 ..... 17  
 50706 ..... 17  
 50710 ..... 17  
 50716 ..... 17  
 50725 ..... 17  
 512 ..... 45  
 512-2 ..... 45  
 513 ..... 45  
 513-2 ..... 45  
 515 ..... 45  
 515-2 ..... 45  
 516 ..... 45  
 516-2 ..... 45  
 517 ..... 45  
 517-2 ..... 45  
 518 ..... 45  
 518-2 ..... 45  
 519 ..... 45  
 520 ..... 45  
 5605-16 ..... 52  
 5605-22 ..... 52  
 5605-28 ..... 52  
 5605-38 ..... 52  
 5605-50 ..... 52  
 5605-60 ..... 52  
 5720 ..... 69  
 5721 ..... 69  
 5722 ..... 69  
 5725 ..... 69  
 5726 ..... 69  
 5727 ..... 69

## 6

601620 ..... 61  
 601922 ..... 61  
 602125 ..... 61  
 611620 ..... 61  
 611922 ..... 61  
 612125 ..... 61  
 679316-1 ..... 118  
 679316-2 ..... 117  
 679316-3 ..... 117  
 679316-4 ..... 117  
 679332-1 ..... 118  
 679332-2 ..... 117  
 679332-3 ..... 117  
 679332-4 ..... 117  
 679363-5 ..... 118  
 679363-6 ..... 118  
 679363-7 ..... 117  
 679363-8 ..... 117  
 679416-1 ..... 118  
 679416-2 ..... 117  
 679416-3 ..... 117  
 679416-4 ..... 117  
 679432-1 ..... 118  
 679432-2 ..... 118  
 679432-3 ..... 117  
 679432-4 ..... 117  
 679463-5 ..... 118  
 679463-6 ..... 118  
 679463-7 ..... 117  
 679463-8 ..... 117  
 679516-1 ..... 118  
 679516-2 ..... 117  
 679516-3 ..... 117



# Index

## 6

679516-4 ..... 117  
679532-1 ..... 118  
679532-2 ..... 118  
679532-3 ..... 117  
679532-4 ..... 117  
679563-5 ..... 118  
679563-6 ..... 118  
679563-7 ..... 117  
679563-8 ..... 117

## 7

700-02 ..... 59  
700-05 ..... 59  
700-08 ..... 59  
700-08 Black 59  
700-11 ..... 59  
700-16 ..... 59  
700-23 ..... 59  
701516 ..... 47  
701920 ..... 47  
702-0 ..... 60  
702-1 ..... 60  
702-2 ..... 60  
702225 ..... 47  
702-2W ..... 33  
702-3 ..... 60  
703235 ..... 47  
710-15 ..... 47  
710-30 ..... 47  
745-4C LG ... 24  
745-8C LG ... 24  
745-CRF748 . 24  
745-EPS4M .. 24  
745-EPS8M .. 24  
745-LAN ..... 24  
755 ..... 131  
761 ..... 67

## 9

9004121 ..... 57  
9004510 ..... 57  
905 ..... 45  
90507 ..... 36  
90509 ..... 36  
90511 ..... 36  
90513 ..... 36  
90516 ..... 36  
90521 ..... 36  
90529 ..... 36  
90536 ..... 36  
90548 ..... 36  
905M12-DMRI 38  
905M16-DMRI 38  
905M20-DMRI 38  
905M25-DMRI 38  
906 ..... 45  
90607 ..... 37  
90609 ..... 37  
90611 ..... 37  
90613 ..... 37  
90616 ..... 37  
906-2 ..... 46  
90621 ..... 37  
90629 ..... 37  
90636 ..... 37  
90648 ..... 37  
907 ..... 45  
90707 ..... 37  
90709 ..... 37  
90711 ..... 37

## 9

90713 ..... 37  
90716 ..... 37  
90721 ..... 37  
90729 ..... 37  
90736 ..... 37  
90748 ..... 37  
907M12 ..... 39  
907M16 ..... 39  
907M20 ..... 39  
907M20 Black 32  
907M25 ..... 39  
907M32 ..... 39  
907M40 ..... 40  
907M50 ..... 40  
907M63 ..... 40  
908 ..... 45  
908M16 ..... 40  
908M20 ..... 40  
908M25 ..... 40  
908M32 ..... 40  
908M40 ..... 40  
908M50 ..... 40  
909M16 ..... 40  
909M20 ..... 40  
90HS4 ..... 65  
90HSM6 ..... 65  
90HSXXX .... 65  
9100001 ..... 48  
9100002 ..... 48  
9100004 ..... 48  
9100005 ..... 48  
9100007 ..... 48  
9100026 ..... 48  
9100029 ..... 48  
9100030 ..... 48  
9100031 ..... 49  
9100037 ..... 49  
9100038 ..... 49  
9100046 ..... 49  
9100047 ..... 49  
9100056 ..... 50  
9100057 ..... 50  
9100066 ..... 49  
9100067 ..... 49  
9100116 ..... 49  
9100120 ..... 49  
9100126 ..... 49  
9100132 ..... 49  
9100140 ..... 49  
9100150 ..... 49  
9100707 ..... 49  
9100900 ..... 48  
9100903 ..... 50  
9200900 ..... 68  
9230460 ..... 51  
9260030 ..... 112  
9316-1 ..... 116  
9316-2 ..... 115  
9316-3 ..... 115  
9316-4 ..... 115  
9332-1 ..... 116  
9332-2 ..... 115  
9332-3 ..... 115  
9332-4 ..... 115  
9401001 ..... 63  
9401051 ..... 69  
9401052 ..... 70  
9416-1 ..... 116  
9416-2 ..... 115

## 9

9416-3 ..... 115  
9416-4 ..... 115  
9421 ..... 71  
9422 ..... 71  
9423 ..... 71  
9424 ..... 71  
9432-1 ..... 116  
9432-2 ..... 115  
9432-3 ..... 115  
9432-4 ..... 115  
950418 ..... 65  
9516-1 ..... 116  
9516-2 ..... 115  
9516-3 ..... 115  
9516-4 ..... 115  
9532-1 ..... 116  
9532-2 ..... 115  
9532-3 ..... 115  
9532-4 ..... 115  
960418 ..... 65  
9700012 ..... 47  
9700016 ..... 47  
9700020 ..... 47  
9700025 ..... 47  
9700028 ..... 47  
9700316 ..... 48  
9700320 ..... 48  
9700325 ..... 48  
9700806 ..... 51  
9700808 ..... 51  
9700810 ..... 51  
9700812 ..... 51  
9700814 ..... 51  
9700816 ..... 51  
9700817 ..... 52  
9700819 ..... 51  
9700820 ..... 52  
9700825 ..... 51  
9700826 ..... 51  
9700828 ..... 51  
9700830 ..... 51  
9700832 ..... 51  
9700834 ..... 51  
9700836 ..... 51  
9700839 ..... 51  
9700845 ..... 52  
9700850 ..... 51  
9700855 ..... 51  
9700860 ..... 51  
9700875 ..... 52  
9700880 ..... 52  
9700916 ..... 49  
9700920 ..... 49  
9700925 ..... 49  
9701016 ..... 48  
9701020 ..... 48  
9701025 ..... 48  
9702816 ..... 51  
9702817 ..... 52  
9702819 ..... 51  
9702820 ..... 52  
9702836 ..... 52  
9702839 ..... 52  
9702845 ..... 53  
9707-ORL01 . 36  
9709-ORL02 . 36  
9711-ORL03 . 36  
9713-ORL04 . 36  
9716-ORL05 . 36

## 9

9721-ORL06 . 36  
9729-ORL07 . 36  
9736-ORL08 . 36  
9748-ORL10 . 36

## A

AM0301 ..... 111  
AM0303 ..... 111  
AM0305 ..... 112  
AM114SS .... 110  
AM117 ..... 109  
AM117-100 ... 109  
AM117-250 ... 109  
AM118 ..... 109  
AM118-100 ... 109  
AM118-250 ... 109  
AM127 ..... 109  
AM127-100 ... 109  
AM128 ..... 109  
AM128-100 ... 109  
AM370 ..... 108  
AM371 ..... 108  
AM374 ..... 108  
AM376 ..... 108  
AM9200026 .. 109  
AM9200027 .. 109  
AM9200028 .. 109  
AM9200029 .. 109  
AM9200030 .. 109  
AMCC1016 ... 112  
AMCC2550 ... 112  
AMCC-D-101E 112  
AMCC-D-255C 112  
AMDS16 ..... 111  
AMDS18 ..... 111  
AMK0310 .... 112  
AML511 ..... 108  
AML512 ..... 108  
AML512-E ... 108  
AML513 ..... 108  
AML514 ..... 108  
AML515 ..... 108  
AMM1 ..... 108  
AMM116 ..... 110  
AMM116-C ... 110  
AMM126 ..... 110  
AMM2 ..... 108  
AMMB116 .... 110  
AMS116 ..... 110  
AMS126 ..... 110  
AMSB116 .... 110  
AMT116 ..... 111  
AMT126 ..... 111

## B

BA43-06 ..... 63  
BA43-08 ..... 63  
BA43-10 ..... 63  
BA43-12 ..... 63  
BM12 ..... 38  
BM16 ..... 38  
BM20 ..... 38  
BM20 Black .. 34  
BM20 White . 34  
BM20LA ..... 15  
BM25 ..... 38  
BM25LA ..... 15  
BM32 ..... 38  
BM40 ..... 38  
BM50 ..... 38

# Index

## B

BM63 ..... 38  
 BS11BEU ..... 95  
 BS21BEU ..... 95  
 BS61BEU ..... 95

## C

C16VD ..... 28  
 C16VD R ..... 28  
 C20VD ..... 28  
 C20VD R ..... 28  
 C25VD ..... 28  
 C25VD R ..... 28  
 C300B ..... 114  
 C300W ..... 114  
 C310B ..... 113  
 C310W ..... 113  
 C311B ..... 113  
 C311W ..... 113  
 C312B ..... 113  
 C313B ..... 113  
 C320B ..... 114  
 C320W ..... 114  
 C321B ..... 114  
 C321W ..... 114  
 C32VD ..... 28  
 C32VD R ..... 28  
 C404 ..... 114  
 C40VD ..... 28  
 C40VD R ..... 28  
 C500 ..... 22  
 C50VD ..... 28  
 C50VD R ..... 28  
 CD12-11DT .. 56  
 CD12-14DT .. 56  
 CD12-18DT .. 56  
 CD12-24DT .. 56  
 CD12-30DT .. 57  
 CD12-9DT .... 56  
 CD4-11DT .... 56  
 CD4-14DT .... 56  
 CD4-18DT .... 56  
 CD4-24DT .... 56  
 CD4-30DT .... 56  
 CD4-9DT ..... 56  
 CD7-5-11DT . 56  
 CD7-5-14DT . 56  
 CD7-5-18DT . 56  
 CD7-5-24DT . 56  
 CD7-5-30DT . 56  
 CD7-5-9DT ... 56  
 CFR748 ..... 24  
 CLT102110R 77  
 CLT102116R 77  
 CLT102129R 77  
 CLT102149R 77  
 CON125 ..... 93  
 CON125M .... 93  
 CON30 ..... 93  
 CON30M ..... 93  
 CON70 ..... 93  
 CON70M ..... 93  
 CON90 ..... 93  
 CON90M ..... 93  
 CP03 ..... 107  
 CP06 ..... 107  
 CP08 ..... 107  
 CP10 ..... 107  
 CP12 ..... 107  
 CP20 ..... 107  
 CPN03 ..... 107

## C

CPN06 ..... 107  
 CPN08 ..... 107  
 CPN10 ..... 107  
 CPN12 ..... 107  
 CPN20 ..... 107

## D

D006/05 ..... 79  
 D006/06 ..... 79  
 D006/08 ..... 79  
 D010/05 ..... 79  
 D010/06 ..... 79  
 D010/08 ..... 79  
 D010/10 ..... 79  
 D016/05 ..... 79  
 D016/06 ..... 79  
 D016/08 ..... 79  
 D016/10 ..... 79  
 D025/06 ..... 79  
 D025/08 ..... 79  
 D025/10 ..... 79  
 D035/06 ..... 79  
 D035/08 ..... 79  
 D035/10 ..... 79  
 D035/12 ..... 79  
 D050/06 ..... 79  
 D050/08 ..... 79  
 D050/10 ..... 79  
 D050/12 ..... 79  
 D070/08 ..... 79  
 D070/10 ..... 79  
 D070/12 ..... 79  
 D070/14 ..... 79  
 D095/08 ..... 79  
 D095/10 ..... 79  
 D095/12 ..... 79  
 D095/14 ..... 79  
 D120/10 ..... 79  
 D120/12 ..... 79  
 D120/14 ..... 79  
 D150/08 ..... 79  
 D150/10 ..... 79  
 D150/12 ..... 79  
 D150/14 ..... 79  
 D185/10 ..... 79  
 D185/12 ..... 79  
 D185/14 ..... 79  
 D240/12 ..... 79  
 D240/14 ..... 79  
 D240/16 ..... 79  
 DB02 ..... 80  
 DB04 ..... 80  
 DB06 ..... 80  
 DB10 ..... 80  
 DB120 ..... 80  
 DB150 ..... 80  
 DB16 ..... 80  
 DB185 ..... 80  
 DB240 ..... 80  
 DB25 ..... 80  
 DB35 ..... 80  
 DB50 ..... 80  
 DB70 ..... 80  
 DB95 ..... 80  
 DHC95 ..... 125  
 DHCR15 ..... 125  
 DVAB1F ..... 81  
 DVAB1M ..... 81  
 DVAB2F ..... 82  
 DVAB2M ..... 82

## D

DVBC 5 ..... 83  
 DVBC1 ..... 81  
 DVBC2 ..... 82  
 DVF1/03 ..... 81  
 DVF1/03.7 ... 81  
 DVF1/04 ..... 81  
 DVF1/05 ..... 81  
 DVF1/06 ..... 81  
 DVF2/03 ..... 82  
 DVF2/03.7 ... 82  
 DVF2/04 ..... 82  
 DVF2/05 ..... 82  
 DVF2/06 ..... 82  
 DVF5/ 03 ..... 83  
 DVF5/ 04 ..... 83  
 DVF5/05 ..... 83  
 DVF5/06 ..... 83  
 DVF5/08 ..... 83  
 DVFP O5 /6.3I 83  
 DVFP O5 /9.5I 83  
 DVFPO1/2.8F 81  
 DVFPO1/4.8F 81  
 DVFPO1/6.3F 81  
 DVFPO2/4.8F 82  
 DVFPO2/6.3F 82  
 DVP 5/ 1 4 .... 83  
 DVP O 5 /6 .3 83  
 DVP O 5 /6 .3 83  
 DVP O 5 /9 .5 83  
 DVP1/09 ..... 81  
 DVP1/12 ..... 81  
 DVP2/09 ..... 82  
 DVP2/12 ..... 82  
 DVPO1/2.8F . 81  
 DVPO1/4.8F . 81  
 DVPO1/4.8M 81  
 DVPO1/6.3F . 81  
 DVPO1/6.3M 81  
 DVPO2/2.8F . 82  
 DVPO2/4.8F . 82  
 DVPO2/6.3F . 82  
 DVPO2/6.3M 82  
 DVPOA1/6.3 . 81  
 DVPOA2/6.3 . 82  
 DVR1/03 ..... 81  
 DVR1/03.7 ... 81  
 DVR1/04 ..... 81  
 DVR1/05 ..... 81  
 DVR1/06 ..... 81  
 DVR1/08 ..... 81  
 DVR1/10 ..... 81  
 DVR1/12 ..... 81  
 DVR2/03 ..... 82  
 DVR2/03.7 ... 82  
 DVR2/04 ..... 82  
 DVR2/05 ..... 82  
 DVR2/06 ..... 82  
 DVR2/08 ..... 82  
 DVR2/10 ..... 82  
 DVR2/12 ..... 82  
 DVR5/04 ..... 83  
 DVR5/05 ..... 83  
 DVR5/06 ..... 83  
 DVR5/08 ..... 83  
 DVR5/10 ..... 83  
 DVR5/12 ..... 83

## E

E10 ..... 87  
 E104 ..... 88

## E

E11 ..... 87  
 E114 ..... 88  
 E12 ..... 87  
 E120 ..... 70, 71  
 E124 ..... 89  
 E13 ..... 86  
 E134 ..... 88  
 E14 ..... 87  
 E144 ..... 88  
 E15 ..... 87  
 E154 ..... 88  
 E16 ..... 86  
 E164 ..... 88  
 E17 ..... 87  
 E174 ..... 88  
 E18 ..... 87  
 E184 ..... 89  
 E19 ..... 87  
 E194 ..... 89  
 E20 ..... 86  
 E22 ..... 86  
 E23 ..... 86  
 E24 ..... 86  
 E25 ..... 86  
 E26 ..... 87  
 E264 ..... 88  
 E27 ..... 87  
 E28 ..... 87  
 E30 ..... 87  
 E31 ..... 87  
 E32 ..... 87  
 E324 ..... 89  
 E33 ..... 87  
 E34 ..... 87  
 E344 ..... 89  
 E35 ..... 87  
 E354 ..... 89  
 E36 ..... 87  
 E364 ..... 89  
 E37 ..... 87  
 E374 ..... 89  
 E38 ..... 87  
 E39 ..... 87  
 E4 ..... 87  
 E40 ..... 87  
 E43 ..... 87  
 E44 ..... 88  
 E48 ..... 87  
 E5 ..... 87  
 E54 ..... 88  
 E6 ..... 87  
 E60 ..... 52  
 E64 ..... 88  
 E7 ..... 87  
 E74 ..... 88  
 E8 ..... 86  
 E84 ..... 88  
 E9 ..... 87  
 E90 ..... 15, 18, 51, 52,  
 53, 69, 70, 134,  
 135  
 E94 ..... 88  
 EASY02 ..... 7  
 EASY04 ..... 7  
 EASY08 ..... 7  
 EASY12 ..... 7  
 EASY18 ..... 7  
 EC16 ..... 29  
 EC16 R ..... 29

# Index

## E

EC20 ..... 29  
 EC20 Black .. 32  
 EC20 R ..... 29  
 EC20 White .. 32  
 EC25 ..... 29  
 EC25 R ..... 29  
 EC60060EZ .. 134  
 EC60100EZ .. 134  
 EC60150EZ .. 134  
 EC60200EZ .. 134  
 EC60300EZ .. 134  
 EC60400EZ .. 134  
 EC60500EZ .. 134  
 EC60600EZ .. 134  
 ECICTA20HF 27  
 ECICTA20HFT 27  
 ECICTA25HF 27  
 ECICTA25HFT 27  
 ECUT ..... 90  
 ED10050 ..... 88  
 ED10075 ..... 88  
 ED12575 ..... 88  
 ED2525 ..... 88  
 ED2537 ..... 88  
 ED2550 ..... 88  
 ED2575 ..... 88  
 ED3737 ..... 88  
 ED3750 ..... 88  
 ED3775 ..... 88  
 ED5050 ..... 88  
 ED5075 ..... 88  
 ED7550 ..... 88  
 ED7575 ..... 88  
 ERFE20G ..... 27  
 ERFE25G ..... 27  
 ETC120 ..... 91

## F

FCV12040 .... 92  
 FCV12060 .... 92  
 FE12 ..... 13  
 FE15 ..... 13  
 FE25 ..... 13  
 FE25 Black ... 35  
 FE25 White .. 35  
 FE7 ..... 13  
 FE7 Black ..... 35  
 FH10-BRDT . 55  
 FH10-DT ..... 54  
 FH10-ICA10D` 54  
 FH10-ICA6DT 54  
 FH10-ICA8DT 54  
 FH15-BRDT . 55  
 FH15-DT ..... 54  
 FH15-ICA10D` 54  
 FH15-ICA6DT 54  
 FH15-ICA8DT 54  
 FH20-BRDT . 55  
 FH20-DT ..... 54  
 FH20-ICA10D` 54  
 FH20-ICA6DT 54  
 FH20-ICA8DT 54  
 FH4-BRDT ... 55  
 FH4-DT ..... 54  
 FH4-ICA10DT 54  
 FH4-ICA6DT 54  
 FH4-ICA8DT 54  
 FLX10 ..... 107  
 FLX20 ..... 107  
 FLX30 ..... 107

## F

FLX40 ..... 107  
 FU12-5DT .... 55  
 FU12-5TM6DT 55  
 FU12-5TM8DT 55  
 FU20DT ..... 55  
 FU20TM6DT 55  
 FU20TM8DT 55  
 FU7DT ..... 55  
 FU7TM6DT .. 55  
 FU7TM8DT .. 55

## G

G10 ..... 84  
 G10BEU ..... 85  
 G11 ..... 84  
 G12 ..... 84  
 G13 ..... 84  
 G14 ..... 84  
 G15 ..... 84  
 G16 ..... 84  
 G16BEU ..... 85  
 G17 ..... 84  
 G17BEU ..... 85  
 G17EK ..... 85  
 G17EKBEU .. 86  
 G18 ..... 84  
 G19 ..... 84  
 G19BEU ..... 85  
 G20BEU ..... 95  
 G23 ..... 84  
 G23BEU ..... 85  
 G24 ..... 84  
 G26 ..... 84  
 G27 ..... 84  
 G27BEU ..... 85  
 G28 ..... 84  
 G30 ..... 84  
 G30BEU ..... 85  
 G31 ..... 84  
 G31BEU ..... 85  
 G31EK ..... 85  
 G31EKBEU .. 86  
 G31KBEU ..... 86  
 G32 ..... 84  
 G33 ..... 84  
 G33BEU ..... 85  
 G35 ..... 84  
 G37 ..... 84  
 G38 ..... 84  
 G39 ..... 84  
 G4 ..... 84  
 G40 ..... 84  
 G40BEU ..... 85  
 G40EK ..... 85  
 G40EKBEU .. 86  
 G41BEU ..... 95  
 G43 ..... 84  
 G44BEU ..... 95  
 G45BEU ..... 95  
 G48 ..... 84  
 G48BEU ..... 85  
 G4BEU ..... 85  
 G4EK ..... 85  
 G5 ..... 84  
 G50 ..... 84  
 G50BEU ..... 85  
 G50EK ..... 85  
 G50EKBEU .. 86  
 G50KBEU ..... 86  
 G6 ..... 84

## G

G6BEU ..... 85  
 G7 ..... 84  
 G8 ..... 84  
 G8BEU ..... 85  
 G9 ..... 84  
 G9BEU ..... 85  
 GCOP025 .... 91  
 GCOP040 .... 91  
 GCOP060 .... 91  
 GCOP080 .... 91  
 GCOP100 .... 91  
 GCOP100BEL 91  
 GCOP120 .... 91  
 GCOP120BEL 91  
 GCOP150 .... 91  
 GCOP150BEL 91  
 GCOP200 .... 91  
 GCOP200BEL 91  
 GT16A ..... 96  
 GT248AB .... 96  
 GT248EB .... 96  
 GT248GB .... 96  
 GT248IB .... 96  
 GT248LB .... 96  
 GT248TB .... 96  
 Guest05 ..... 107  
 Guest10 ..... 107  
 Guest20 ..... 107  
 Guest30 ..... 107  
 Guest50 ..... 107  
 H  
 HB0050 ..... 70  
 HB0060 ..... 70  
 HB0070 ..... 70  
 HB0080 ..... 70  
 HB0100 ..... 70  
 HB0120 ..... 70  
 HB0150 ..... 70  
 HB0180 ..... 70  
 HF ..... 8, 9, 10, 11, 12,  
 13, 14, 15, 18,  
 19, 20, 21, 22,  
 24, 26, 27, 28,  
 29, 32, 33, 34,  
 35, 36, 37, 38,  
 39, 40, 41, 43,  
 44, 45, 46, 47,  
 59, 60, 61, 72,  
 73, 74, 75, 76,  
 77, 78, 90, 97,  
 98, 99, 102,  
 103, 115, 116,  
 117, 118, 131  
 HTC18S ..... 7

## I

IW10054B .... 102  
 IW10054BEK 102  
 IW10054BHL 102  
 IW10054Black 102  
 IW10054EKBlk 102  
 IW10054LHBlk 102  
 IW2012.5B ... 97  
 IW2012.5Blac 98  
 IW2012.5LHBl 99  
 IW20125LH .. 99  
 IW2020LH .... 99  
 IW4017B ..... 97  
 IW4017Black 98  
 IW4017LH .... 99  
 IW4017LHBlac 99

## I

IW6040LH .... 99  
 IWAE10054B 103  
 IWAE10054Blk 103  
 IWAE2012B .. 97  
 IWAE2012Blac 98  
 IWAE4017B .. 97  
 IWAE4017Blac 98  
 IWAI10054B . 103  
 IWAI10054Bla 103  
 IWAI2012B ... 97  
 IWAI2012Blac 98  
 IWAI4017B ... 97  
 IWAI4017Blac 98  
 IWAP10054B 103  
 IWAP10054Blk 103  
 IWAP2012B .. 97  
 IWAP2012Blac 98  
 IWAP4017B .. 97  
 IWAP4017Blac 98  
 IWGT10054B 103  
 IWGT10054Blk 103  
 IWGT2012B . 97  
 IWGT2012Blac 98  
 IWGT4017B . 97  
 IWGT4017Blac 98  
 IWGU100 ..... 103  
 IWGU100Blac 103  
 IWGU2012B . 97  
 IWGU2012Bla 98  
 IWGU4017B . 97  
 IWGU4017Blac 98  
 IWS10040B .. 103  
 IWS10040Blac 103  
 IWTT10054B 103  
 IWTT10054Blk 103  
 IWTT2012B .. 97  
 IWTT2012Blac 98  
 IWTT4017B .. 97  
 IWTT4017Blac 98  
 IZ10/2F/54 .... 23  
 IZ10/3F/54 .... 23  
 IZ16/2F/54 .... 23  
 IZ16/3F/54 .... 23  
 IZ16/4F/56 .... 23  
 IZS10/3F/54 . 23  
 IZS16/2F/54 . 23  
 IZS16/3F/54 . 23  
 IZS16/4F/56 . 23  
 J  
 J100B ..... 9  
 J100BF ..... 15  
 J100L ..... 9  
 J100S ..... 8  
 J100S Black . 34  
 J100S CONNE 8  
 J100S White . 34  
 J100SF ..... 15  
 J1207PAD .... 95  
 J1602 ..... 15  
 J160B ..... 9  
 J160BF ..... 15  
 J160L ..... 9  
 J1610PAD .... 95  
 J200B ..... 9  
 J200BF ..... 15  
 J200L ..... 9  
 J2021 ..... 15  
 J402 ..... 15  
 J80B ..... 9

# Index

## J

J80L ..... 9

## K

KCP00S ..... 7  
 KP64-50-2LD 18  
 KP64-50-3LD 18  
 KP64-50-4LD 18  
 KP64-50-5LD 18  
 KP64-50LD ... 18  
 KP645L ..... 18  
 KP64-60LD ... 18  
 KPZ-1-PO ..... 18  
 KT3001 ..... 126, 127  
 KT3002-3204 126  
 KT3002-3704 127  
 KT3204 ..... 126  
 KT3604 ..... 127  
 KT3704 ..... 126  
 KTA00S ..... 7

## L

LD075ABEU . 106  
 LD075EBEU . 105  
 LD075IBEU .. 105  
 LD075LBEU . 105  
 LD075TBEU . 106  
 LD105EBEU . 105  
 LD105LBEU . 105  
 LD105TBEU . 106  
 LD125EBEU . 105  
 LD125IBEU .. 105  
 LD125LBEU . 105  
 LD125TBEU . 106  
 LDJ01 ..... 6  
 LHD2010HF . 99  
 LHD2020HF . 99  
 LHD4020HF . 99  
 LHD4040HF . 100  
 LHD8623HF . 101  
 LHD8624HF . 101, 106  
 LHD8625HF . 100  
 LHD8626HF . 100  
 LHD8633HF . 101  
 LHD8634HF . 101, 106  
 LHD8635HF . 100  
 LHD8636HF . 100  
 LHD8643HF . 101  
 LHD8644HF . 101, 106  
 LHD8645HF . 100  
 LHD8646HF . 100  
 LHD8923HF . 101  
 LHD8924HF . 101, 106  
 LHD8925HF . 100  
 LHD8926HF . 100

## M

M001CS ..... 14  
 M002CS ..... 14  
 M003CS ..... 14  
 M005CS ..... 14  
 M512 ..... 46  
 M512-2 ..... 46  
 M515 ..... 46  
 M515-2 ..... 46  
 M518 ..... 46  
 M518-2 ..... 46  
 M522 ..... 46  
 M522-2 ..... 46  
 MCLIC ..... 135  
 ME1216 ..... 41  
 ME1620 ..... 41

## M

ME2025 ..... 41  
 ME2532 ..... 41  
 ME3240 ..... 41  
 MET22102R . 76  
 MET22105R . 76  
 MET22110R . 76  
 MET22111R . 76  
 MET22112R . 76  
 MET22123R . 76  
 MET22126R . 76  
 MET22140R . 76  
 MET22534R . 76  
 MET32102R . 76  
 MET32105R . 76  
 MET32110R . 76  
 MET32111R . 76  
 MET32112R . 76  
 MET32123R . 76  
 MET32126R . 76  
 MET32140R . 76  
 MET32326R . 76  
 MET32534R . 77  
 MF001 ..... 3  
 MF002 ..... 3  
 MF111 ..... 77  
 MF242 ..... 11  
 MFBOX01 .... 120  
 MFM46 ..... 119  
 MFPS17 ..... 119  
 MFR253G25 . 119  
 MFR403G25 . 119  
 MFVS10 ..... 119  
 MFVS15 ..... 119  
 MFVS20 ..... 119  
 MFVS25 ..... 119  
 MFVS30 ..... 119  
 MFVS40 ..... 119  
 MFVS50 ..... 119  
 MIB16 ..... 10  
 MIB21 ..... 10  
 MIB29 ..... 10  
 MIBR1620 .... 29  
 MIBR1620 Bla 32  
 MIBR1620 Wh 32  
 MJB112 ..... 6  
 MJB113 ..... 6  
 MJB215 ..... 6  
 MJB222 ..... 6  
 MJB332 ..... 6  
 MP0030 ..... 4  
 MP0100 ..... 4  
 MP1000 ..... 4  
 MP2200 ..... 4  
 MPONE GEL 4  
 MR1612 ..... 41  
 MR2012 ..... 41  
 MR2016 ..... 41  
 MR2512 ..... 41  
 MR2516 ..... 41  
 MR2520 ..... 41  
 MR3212 ..... 41  
 MR3216 ..... 41  
 MR3220 ..... 41  
 MR3225 ..... 41  
 MR4016 ..... 41  
 MR4020 ..... 41  
 MR4025 ..... 41  
 MR4032 ..... 41  
 MR5020 ..... 41

## M

MR5025 ..... 41  
 MR5032 ..... 41  
 MR5040 ..... 41  
 MR6325 ..... 41  
 MR6332 ..... 41  
 MR6340 ..... 41  
 MR6350 ..... 41  
 MT60100075 133  
 MT60100100 133  
 MT60200075 133  
 MT60200100 133  
 MT60300075 133  
 MT60300100 133  
 MT6075075 .. 133  
 MTCTS100 ... 133  
 MTCTS200 ... 133  
 MTCTS300 ... 133  
 MTLTS100 ... 134  
 MTLTS150 ... 134  
 MTLTS200 ... 134  
 MTLTS300 ... 134  
 MTN60100075 133  
 MTN60100100 133  
 MTN60200075 133  
 MTN60200100 133  
 MTN60300075 133  
 MTN60300100 133

## N

N12-C ..... 20  
 N12-D ..... 21  
 N18-C ..... 20  
 N24-C ..... 20  
 N24-D ..... 21  
 N2x18-C ..... 20  
 N36-C ..... 20  
 N36-D ..... 21  
 N3x18-C ..... 20  
 N48-C ..... 20  
 N4-C ..... 20  
 N4-D ..... 20  
 N4x18-C ..... 20  
 N8-C ..... 20  
 N8-D ..... 20  
 NEW ..... 3, 18, 35, 97,  
 98, 99, 102,  
 128

## O

OL70211 ..... 60  
 OL70212 ..... 60  
 OL70213 ..... 60  
 OL70214 ..... 60  
 OL70215 ..... 60  
 OL70216 ..... 60  
 OL70217 ..... 60  
 OL70218 ..... 60  
 OMBG01 ..... 42  
 OMBG02 ..... 42  
 OMBG03 ..... 42  
 OMBG04 ..... 42  
 OMBG05 ..... 42  
 OMBG06 ..... 42  
 OMBG07 ..... 42  
 OMBG08 ..... 42  
 OMBL01 ..... 42  
 OMBL02 ..... 42  
 OMBL03 ..... 42  
 OMBL04 ..... 42  
 OMBL05 ..... 42  
 OMBL06 ..... 42

## O

OMBL07 ..... 42  
 OMBL08 ..... 42  
 OMRL03 M16 39  
 OMRL05 M20 39  
 OMRL05A7 .. 38  
 OMRL09 M50 39  
 OMRL10 M63 39

## P

P1ES ..... 63  
 P2ES ..... 63  
 P3ES ..... 63  
 PC0015 ..... 132  
 PC0018 ..... 132  
 PC0022 ..... 132  
 PC0028 ..... 132  
 PC0035 ..... 132  
 PC0042 ..... 132  
 PC0048 ..... 132  
 PC0054 ..... 132  
 PC0060 ..... 132  
 PC0064 ..... 132  
 PC1075 ..... 132  
 PC1090 ..... 132  
 PC1100 ..... 132  
 PC1110 ..... 132  
 PC1115 ..... 132  
 PC1125 ..... 132  
 PC1133 ..... 132  
 PC1140 ..... 132  
 PC1150 ..... 132  
 PC1160 ..... 132  
 PD15ZF4 ..... 67  
 PD32ZF6 ..... 67  
 PD35CZ ..... 67  
 PD35CZF6 ... 67  
 PD35Z ..... 67  
 PD35ZF6 ..... 67  
 PDTR2M ..... 67  
 PICSHARK68( 6  
 PICSHARK68( 6  
 PICSHARK68( 6  
 PICSHARK68( 6  
 PICSHARK68( 6  
 PICSHARK68( 6  
 PIN003-CTTN 76  
 PIN005 ..... 75  
 PIN006-CTTS 76  
 PM12 ..... 39  
 PM16 ..... 39  
 PM20 ..... 39  
 PM25 ..... 39  
 PM32 ..... 39  
 PM40 ..... 39  
 PM50 ..... 39  
 PM63 ..... 39  
 PRRIV1 ..... 89  
 PRRIV2 ..... 89  
 PTR ..... 89

## R

RH18S ..... 21  
 RH36/2S ..... 21  
 RH54/3S ..... 21  
 RH72/4S ..... 21  
 RIV1 ..... 89  
 RIV2 ..... 89  
 RS150 ..... 4  
 RS1650 ..... 4  
 RS300 ..... 4

# Index

## R

RS400 ..... 4  
RS550 ..... 4  
RS650 ..... 4

## S

S1 ..... 92  
S2 ..... 92  
SAE160BEU .. 105  
SAI160BEU .. 100, 105  
SAP160BEU .. 105  
SB17-11DT ... 56  
SCO45 ..... 104  
SDK3 ..... 17  
SDK5 ..... 17  
SDK8 ..... 17  
SDKF2TR-AN 17  
SDKF3TR-AN 17  
SDKF5TR-AN 17  
SEL.10.202R 74  
SEL.10.210R 74  
SEL.10.223R 74  
SEL.10.425R 74  
SEL.11.202R 74  
SEL.11.210R 74  
SEL.11.223R 74  
SEL.11.425R 74  
SEL.12.202R 74  
SEL.12.210R 74  
SEL.12.223R 74  
SEL.12.425R 74  
SEL.14.202R 74  
SEL.14.210R 74  
SEL.14.223R 74  
SEL.14.425R 74  
SEL.2.202T .. 74  
SEL101 ..... 78  
SEL2142 ..... 73  
SEL2143 ..... 73  
SEL2144 ..... 73  
SEL2155 ..... 73  
SEL2201 ..... 73  
SEL2202 ..... 73  
SEL2203 ..... 73  
SEL2204 ..... 73  
SEL2205 ..... 73  
SEL2210 ..... 73  
SEL2211 ..... 73  
SEL2212 ..... 73  
SEL2214 ..... 73  
SEL2216 ..... 73  
SEL2220 ..... 73  
SEL2221 ..... 73  
SEL2222 ..... 73  
SEL2223 ..... 73  
SEL2224 ..... 73  
SEL2401 ..... 78  
SEL2402 ..... 78  
SEL2403 ..... 78  
SEL2425 ..... 73  
SEL2426 ..... 73  
SEL2427 ..... 73  
SEL2428 ..... 73  
SEL2429 ..... 73  
SEL2430 ..... 73  
SEL2431 ..... 73  
SEL2432 ..... 73  
SEL2433 ..... 73  
SEL2434 ..... 73  
SEL2435 ..... 72, 73  
SEL2436 ..... 73

## S

SEL2438 ..... 73  
SEL2441 ..... 73  
SEL2447 ..... 73  
SEL2450 ..... 73  
SEL2451 ..... 73  
SEL2452 ..... 73  
SEL2453 ..... 73  
SEL2501 ..... 77  
SEL2502 ..... 77  
SEL3142 ..... 72  
SEL3143 ..... 72  
SEL3144 ..... 72  
SEL3150 ..... 72  
SEL3155 ..... 72  
SEL3201 ..... 72  
SEL3202 ..... 72  
SEL3203 ..... 72  
SEL3204 ..... 72  
SEL3205 ..... 72  
SEL3210 ..... 72  
SEL3211 ..... 72  
SEL3212 ..... 72  
SEL3214 ..... 72  
SEL3215 ..... 73  
SEL3216 ..... 72  
SEL3220 ..... 72  
SEL3221 ..... 72  
SEL3222 ..... 72  
SEL3223 ..... 72  
SEL3224 ..... 72  
SEL3320 ..... 75  
SEL3321 ..... 75  
SEL3322 ..... 75  
SEL3323 ..... 75  
SEL3324 ..... 75  
SEL3425 ..... 72  
SEL3426 ..... 72  
SEL3427 ..... 72  
SEL3428 ..... 72  
SEL3429 ..... 72  
SEL3430 ..... 72  
SEL3431 ..... 72  
SEL3432 ..... 72  
SEL3433 ..... 72  
SEL3434 ..... 72  
SEL3436 ..... 72  
SEL3437 ..... 73  
SEL3438 ..... 72  
SEL3441 ..... 72  
SEL3447 ..... 72  
SEL3451 ..... 72  
SEL3452 ..... 72  
SEL3453 ..... 72  
SEL712006 .. 61  
SEL712008 .. 61  
SEL712010 .. 61  
SEL712012 .. 61  
SELCOG101 62  
SELCXP102 . 62  
SELCXP104 . 62  
SELCXP106 . 62  
SELPXV101 . 62  
SELRXO101 . 62  
SELRXO102 . 62  
SGACBEU ... 104  
SGCOBEU ... 105  
SHARK150 ... 4  
SHARK306 ... 4  
SHARK325 ... 4

## S

SHARK506 ... 5  
SHARK506W 5  
SHARK516 ... 5  
SHARK516Y 5  
SHARK525W 5  
SHARK6801A 6  
SHARK6801B 6  
SHARK6801C 6  
SHARK6801D 6  
SHARK6802A 6  
SHARK6803A 6  
SOC10SG ... 135  
SOC15SG ... 135  
SOC20SG ... 135  
SOC30SG ... 135  
SOPC10SG .. 134  
SOPC15SG .. 134  
SOPC20SG .. 134  
SOPC30SG .. 134  
Spirado ..... 129  
Spiratrek ..... 129  
SSCT1 ..... 75  
SSCT2 ..... 75  
SSCT3 ..... 75  
SSCT4 ..... 75  
SSCT5 ..... 75  
SSCT6 ..... 75  
SSCT7 ..... 75  
STT125BEU . 106  
STT160BEU . 106  
SYS1051 ..... 104  
SYS1252 ..... 104  
SYS1603 ..... 104  
SYS751 ..... 104

## T

TC57 ..... 65  
TCGUN ..... 66  
TP151920BK 58  
TP151920BL 58  
TP151920BN 58  
TP151920GR 58  
TP151920GR 58  
TP151920GY 58  
TP151920RD 58  
TP151920WT 58  
TP151920YL 58  
TP155020RD 58  
TP155020YL 58  
TPQSM32 ... 22  
TR06 ..... 89  
TR08 ..... 89  
TR10 ..... 89  
TR10006 ..... 69  
TR10008 ..... 69  
TR10010 ..... 69  
TR10012 ..... 69  
TR20006 ..... 69  
TR20008 ..... 69  
TR20010 ..... 69  
TR20012 ..... 69  
TR30006 ..... 69  
TR30008 ..... 69  
TR30010 ..... 69  
TR30012 ..... 69

## U

U12-C ..... 20  
U18-C ..... 20  
U24-C ..... 20

## U

U2x18-C ..... 20  
U36-C ..... 20  
U3x18-C ..... 20  
U407 ..... 28  
U407 R ..... 28  
U408 ..... 28  
U408 Black ... 33  
U408 R ..... 28  
U408 White .. 33  
U409 ..... 28  
U409 Black ... 33  
U409 R ..... 28  
U410 ..... 28  
U410 R ..... 28  
U411 ..... 28  
U411 R ..... 28  
U412 ..... 28  
U412 R ..... 28  
U413R ..... 28  
U4-C ..... 20  
U8-C ..... 20

## V

V6H100100 .. 90  
V6H10060 .... 90  
V6H10080 .... 90  
V6H2525 ..... 90  
V6H4025 ..... 90  
V6H4040 ..... 90  
V6H4060 ..... 90  
V6H4080 ..... 90  
V6H60100 .... 90  
V6H60120 .... 90  
V6H6025 ..... 90  
V6H6040 ..... 90  
V6H6060 ..... 90  
V6H6080 ..... 90  
V6H80100 .... 90  
V6H80120 .... 90  
V6H8025 ..... 90  
V6H8040 ..... 90  
V6H8060 ..... 90  
V6H8080 ..... 90  
VD16 ..... 25  
VD16 FLH .... 26  
VD16 LLH .... 26  
VD16 MLH .... 26  
VD16 R ..... 25  
VD16 R-2M .. 25  
VD16-2M ..... 25  
VD16R-1.5M 25  
VD20 ..... 25  
VD20 Black .. 32  
VD20 Black-1. 32  
VD20 Black-2 32  
VD20 FLH .... 26  
VD20 G ..... 25  
VD20 LLH .... 26  
VD20 LLHBLA 26  
VD20 MLH .... 26  
VD20 R ..... 25  
VD20 R-2M .. 25  
VD20 White .. 32  
VD20 White-2 32  
VD20-2M ..... 25  
VD20HFPP ... 27  
VD20HFPPMC 27  
VD20R-1.5 ... 25  
VD25 ..... 25  
VD25 LH ..... 26

# Index

---

## V

VD25 LLH ..... 26  
VD25 R ..... 25  
VD25HPPPMC 27  
VD25R-1.5M 25  
VD32 ..... 25  
VD32 LH ..... 26  
VD32 LLH ..... 26  
VD32 R ..... 25  
VD32R-1.5M 25  
VD40 ..... 25  
VD40 LH ..... 26  
VD40 R ..... 25  
VD50 ..... 25  
VD50 LH ..... 26  
VD50 R ..... 25  
VD63 LH ..... 26  
VD63R ..... 25  
VS03XLDE ... 3  
VS05XLE ..... 3  
VS120E ..... 3  
VS250E ..... 3  
VS500E ..... 3

## W

W10 ..... 122  
W10.1 ..... 122  
W100 ..... 123  
W1000 ..... 121  
W11850200 .. 3  
W16 ..... 123  
W25 ..... 124  
W30 ..... 123  
W300 ..... 124  
W400 ..... 124  
W4-16 ..... 121  
W50 ..... 121  
W500 ..... 125  
W8-27 ..... 121  
WAB05200 ... 91  
WBLI13 ..... 123  
WBLI28H4 .... 122  
WBLI3SOLAR 125  
WBLI5 ..... 124  
WBLI7SOLAR 125  
WBLIS428 .... 122

## Z

Z103F ..... 23  
Z162F ..... 23  
Z163F ..... 23  
Z164F ..... 23  
ZBFB ..... 94  
ZBFG ..... 94  
ZBFG-M ..... 94

**WWW.GSV.BE**

04/2021



#GSV-WEB



#GSV

TERBEKEHOFDREEF 51  
2610 WILRIJK

T: 03 326 50 77  
F: 03 326 49 23

**WWW.GSV.BE**  
**E: OFFICE@GSV.BE**

BTW/TVA BE 0427.142.369  
HRA/RCA 245.824



**SINDS – DEPUIS 1985**

WIJ BEVESTIGEN UW TOEKOMST  
UNE ATTACHE POUR VOTRE AVENIR