

 HALOGEN FREE  FIRE RESISTANT

BEVESTIGINGSMATERIAAL MATERIEL DE FIXATION

CATALOGUS
CATALOGUE

2021
02

G2V 

SINDS | DEPUIS 1985

WIJ BEVESTIGEN UW TOEKOMST
UNE ATTACHE POUR VOTRE Avenir

PVC BUIZEN EN TOEBEHOREN TUBES PVC ET ACCESSOIRES

Buizen HALOGEN FREE- PC
Tubes HALOGEN FREE - PC



BESTELNUMMER N° DE COMMANDE	∅	
VD16 LLH	16 mm	111/5550 m
VD20 LLH	20 mm	111/5550 m
VD20 LLHBLACK	20 mm*	111/5550 m
VD25 LLH	25 mm	57/5130 m
VD32 LLH	32 mm	57 /4275 m

Light Load (2442) : LLH
Lengte / Longueur: 3m
RAL 7035 / *Black RAL 9004
PC = polycarbonaat/polycarbonate



Buizen HALOGEN FREE - PC
Tubes HALOGEN FREE - PC



BESTELNUMMER N° DE COMMANDE	∅	
VD16 MLH	16 mm	111/5550 m
VD20 MLH	20 mm	111/5550 m

Medium Load (3442) : MLH - PC = polycarbonaat/polycarbonate
Lengte / Longueur: 3m - RAL 7035



Buizen HALOGEN FREE - PC
Tubes HALOGEN FREE - PC



BESTELNUMMER N° DE COMMANDE	∅	
VD16 FLH	16 mm	111/5550 m
VD20 FLH	20 mm	111/5550 m
VD25 LH	25 mm	57/5130 m
VD32 LH	32 mm	57/4275 m
VD40 LH	40 mm	30 m
VD50 LH	50 mm	15 m
VD63 LH	63 mm	3 m

Heavy Load (4442) : FLH/LH
Lengte / Longueur: 3m
RAL 7035
PC = polycarbonaat/polycarbonate



PVC BUIZEN EN TOEBEHOREN TUBES PVC ET ACCESSOIRES

Buizen HALOGEN FREE PP met manchet
Tubes HALOGEN FREE PP avec manchon



BESTELNUMMER N° DE COMMANDE	∅	
VD20HFPPMOF	20 mm	102/5100 m
VD25HPPPMOF	25 mm	75/3750 m

Light Grey = RAL 7035
PP= polypropylène/polypropyleen



Buis halfzacht, met trekdraad
Tube semi rigide, avec tire-fil



BESTELNUMMER N° DE COMMANDE	∅	
ERFE20G	20 mm	100 m
ERFE25G	25 mm	50 m



Ribbenbuis
Flex



BESTELNUMMER N° DE COMMANDE	∅	
ECICTA20HFT	20 mm	100 m
ECICTA25HFT	25 mm	50 m
ECICTA20HF	20 mm*	100 m
ECICTA25HF	25 mm*	50 m

* ECICTA20HFT en / et 25HFT : Met trekdraad / Avec tire-fil



Moffen voor rechte PVC buis
Manchons pour conduite rigide en PVC



BESTELNUMMER N° DE COMMANDE	∅	RAL	
U407	16 mm	RAL 7035	100/2500
U408	20 mm	RAL 7035	100/1600
U409	25 mm	RAL 7035	25/1150

Light Grey = RAL 7035
R = Dark Grey = RAL 7037



PVC BUIZEN EN TOEBEHOREN TUBES PVC ET ACCESSOIRES

Moffen voor rechte PVC buis

Manchons pour conduite rigide en PVC



BESTELNUMMER N° DE COMMANDE	ø	RAL	
U410	32 mm	RAL 7035	25/600
U411	40 mm	RAL 7035	25
U412	50 mm	RAL 7035	5
U407 R	16 mm	RAL 7037	100/2500
U408 R	20 mm	RAL 7037	100/1600
U409 R	25 mm	RAL 7037	25/1150
U410 R	32 mm	RAL 7037	25/600
U411 R	40 mm	RAL 7037	25
U412 R	50 mm	RAL 7037	5
U413R	63 mm	RAL 7037	5

Light Grey = RAL 7035

R = Dark Grey = RAL 7037



Bochten 90° voor rechte PVC buis

Coudes 90° pour conduite rigide en PVC



BESTELNUMMER N° DE COMMANDE	ø	RAL	
C16VD	16 mm	RAL 7035	50
C20VD	20 mm	RAL 7035	50
C25VD	25 mm	RAL 7035	5
C32VD	32 mm	RAL 7035	5
C40VD	40 mm	RAL 7035	5
C50VD	50 mm	RAL 7035	3
C16VD R	16 mm	RAL 7037	50
C20VD R	20 mm	RAL 7037	50
C25VD R	25 mm	RAL 7037	5
C32VD R	32 mm	RAL 7037	5
C40VD R	40 mm	RAL 7037	5
C50VD R	50 mm	RAL 7037	3

Light Grey = RAL 7035

R = Dark Grey = RAL 7037



PVC BUIZEN EN TOEBEHOREN TUBES PVC ET ACCESSOIRES

Eindtullen voor rechte PVC buis

Embouts pour conduite rigide en PVC



BESTELNUMMER N° DE COMMANDE	∅	RAL	
EC16	16 mm	RAL 7035	100/7000
EC20	20 mm	RAL 7035	100/5500
EC25	25 mm	RAL 7035	50/2500
EC16 R	16 mm	RAL 7037	100/7000
EC20 R	20 mm	RAL 7037	100/5500
EC25 R	25 mm	RAL 7037	50/2500

Light Grey = RAL 7035

R = Dark Grey = RAL 7037



Invoertule M20

Entrées tube M20



BESTELNUMMER N° DE COMMANDE	∅	
MIBR1620	16 & 20 mm	50/2000

Light Grey = RAL 7035



PVC - LSOH PVC - LSOH

Kabeldozen met uitbrekbare ingangen voor wartels

Boîtes de dérivation avec entrées pré-imprimées



BESTELNUMMER N° DE COMMANDE	Ingangen Entrées	ø	Afm. Dim.	
220A	7	PG 16	80x80x50	10
220AM	7	20 mm	80x80x50	10

220A : Pg-maten / Mesures Pg

220AM : Metrische maten / Mesures métriques

IP 54 Druksluiting / Serrage à pression



Kabeldozen met uitbrekbare ingangen

Boîtes de dérivation avec entrées pré-imprimées



BESTELNUMMER N° DE COMMANDE	Ingangen Entrées	ø	Afm. Dim.	
222A	6	PG 16	100x100x55	5
223A	10	PG 16	175x110x66	2
223ATA	10	PG 16	175x110x83	2
224A	10	PG 29	220x170x120	1
222AM	6	20 mm	100x100x55	5
223AM	10	20 mm	175x110x66	2
223ATAM	10	20 mm	175x110x83	2
224AM	10	25 mm	220x170x120	1

222A à 224A : Pg-maten / Mesures Pg

222AM à 224AM : Metrische maten / Mesures métriques

Schroefsluiting / Serrage à vis 3/4"

IP 65



BOX LINE Kabeldoos met metrische schroefingangen

BOX LINE Boîte de dérivation avec filetage métrique

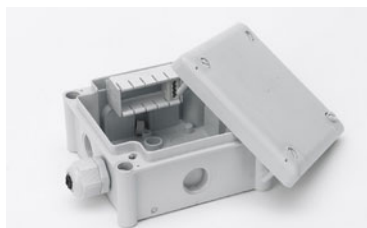

BESTELNUMMER N° DE COMMANDE	Ingangen Entrées	ø	Afm. Dim.	
J100S	7	M20	102 ² x56 mm	90
J100S CONNECTOR	7	M20	102 ² x56 mm	90

inclusief connector 3-fasen+n+t

inclus barrette 3-phases+n+t

IP 66



PVC - LSOH PVC - LSOH

BOX LINE Kabeldozen met nippel

BOX LINE Boîtes de dérivation avec entrées étanches



BESTELNUMMER N° DE COMMANDE	Ingangen Entrées	ø	Afm. Dim.	
J80B	8	M25	83x50mm	1
J100B	8	M25	102x56mm	1
J160B	8	M25	116x70mm	1
J200B	8	M32	216x166x90n	1

IP 66



BOX LINE Kabeldozen gesloten

BOX LINE Boîtes de dérivation fermée



BESTELNUMMER N° DE COMMANDE	Ingangen Entrées	ø	Afm. Dim.	
J80L	8	M25	83 x 83 x 50 mm	1
J100L	8	M25	102 x 102 x 56mm	1
J160L	8	M25	166 x 116 x 70 mm	1
J200L	8	M32	216x166x90n	1

IP 66



Kabeldozen met nippels

Boîtes de dérivation avec entrées étanches



BESTELNUMMER N° DE COMMANDE	Ingangen Entrées	ø	Afm. Dim.	
219B	4*	PG21	45 x ø80 mm	10
220B	7*	20mm	80 x 80 x 50 mm	10
222B	6**	Pg21	100 x 100 x 55 mm	5
223B	10**	Pg21	175 x 110 x 66 mm	2
223BTA	10**	Pg21	175 x 110 x 83 mm	2
224B	10**	Pg29	220 x 170 x 120 mm	1
226B	10**	Pg29	220 x 170 x 120 mm	1

*Druksluiting / Serrage à pression

**Schroefsluiting 3/4" / Serrage à vis 3/4"

IP 54



Nippels

Embouts à gradin



BESTELNUMMER N° DE COMMANDE	Afm. Dim.	
MIB16	3,5-20 mm	50
MIB21	3,5-23,5 mm	50
MIB29	3,5-32 mm	50



Groot formaat Grands formats

Kabeldozen gesloten

Boîtes de dérivation fermées



BESTELNUMMER N° DE COMMANDE	Afm. Dim.
MF242	322x275x185



Kabeldozen volledig gesloten met transparant deksel

Boîtes de dérivation fermées avec couvercle transparente



BESTELNUMMER N° DE COMMANDE	Afm. Dim.
223LTATR	175x110x83
224LTR	220x170x120

Schroefsluiting 3/4" / Serrage à vis 3/4"



Thermoplastisch Thermoplastique

Kabeldozen

Boîtes de dérivation



BESTELNUMMER N° DE COMMANDE	Ingangen Entrées	∅	Afm. Dim.	
FE25	10	1,5-4mm	89x43x37	10/150
FE7	7	1,5-4mm	75x75x37	10/300
FE12	12	1,5-4mm	85x85x37	10/150
FE15	12	1,5-4mm	100x100x37	10/128



Met soupele ingang Avec membrane

Ronde Kabeldoos met soupele ingang

Boîte ronde de dérivation avec membrane



BESTELNUMMER N° DE COMMANDE	Afm. Dim.	
M001CS	ø 65x40 mm	1
M002CS	ø 80x40 mm	1



Kabeldoos met soupele ingang

Boîte de dérivation avec membrane



BESTELNUMMER N° DE COMMANDE	Afm. Dim.	
M003CS	80x80x40 mm	1
M005CS	100x100x40 mm	1



Kabeldozen PH-4A.1

Boîtes de dérivation IP65



BESTELNUMMER N° DE COMMANDE	Normes	Afm. Dim.	
28.41	IP65	248x198x96	1
28.51	IP65	348x228x142	1
28.61	IP65	400x262x140	1



Met soupele ingang Avec membrane

Kabeldozen met nippels PH-4A.3

Boîtes de dérivation avec entrées étanches PH-4A.3



BESTELNUMMER N° DE COMMANDE	Specificiteit Spécificités	Normes	Afm. Dim.	
28.43		IP65	248x198x96	1
28.43-PLEXI	*4		*248x198x96	1

*Met Plexi deksel - Op aanvraag

* Avec couvercle en Plexi - sur demande



Kabeldozen met nippels PH-5A.3

Boîtes de dérivation avec entrées étanches PH-5A.3



BESTELNUMMER N° DE COMMANDE	Normes	Afm. Dim.	
28.53	IP65	348x228x142	1



INBOUWDOZEN BOITES D'ENCASTREMENT

Hollewanddozen

Boîtiers pour mur creux



BESTELNUMMER N° DE COMMANDE	MOD.	ø	Afm. Dim.	
424	1	68 mm	45 mm	10/280
426	1	68 mm	61 mm	10/240
428	2	68 mm	45 mm	5/130
429	3	68 mm	45 mm	5/90



Hollewanddoos vuurvast

Boîtier pour mur creux résistant au feu

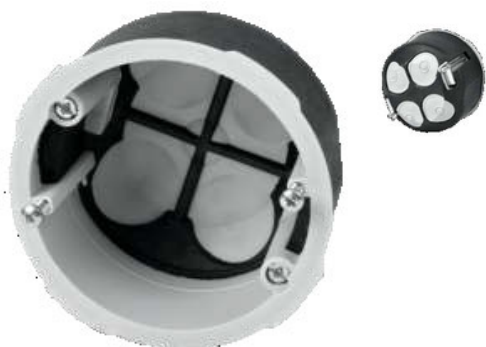

BESTELNUMMER N° DE COMMANDE	ø	Afm. Dim.	
KPZ1PO	68 mm	47 mm	1

PP (halogen-free, pb-free) + foaming material
temperature resistance: -5 - +60 °C (activation of foaming material from 200 °C)

EN 1363-1:2013

EI 15 - EI 120



Universele inbouwdozen zonder Vijs

Boîtiers d'encastrement universel sans Vis

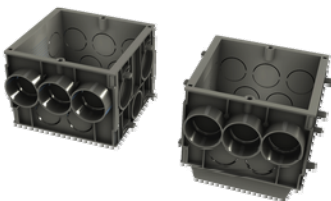

BESTELNUMMER N° DE COMMANDE	MOD.	Afm. Dim.	
430	1	60x60x50mm	10/200
431	1	60x60x65mm	10/200



Universele inbouwdozen met Vijs

Boîtiers d'encastrement universel avec Vis



BESTELNUMMER N° DE COMMANDE	MOD.	Afm. Dim.	
430V	1	60x60x50mm	10/200
431V	1	60x60x65mm	10/180



INBOUWDOZEN BOITES D'ENCASTREMENT

Inbouwdozen

Boîtiers d'encastrement



BESTELNUMMER N° DE COMMANDE	MOD.	Afm. Dim.	
316	1	75x75x42mm	10/100
318	1	75x75x60mm	10/100



VERDEELKASTEN COFFRETS DE DISTRIBUTION

Verdeelkasten opbouw Type C / IP 40 In-63A

Coffrets de distribution en saillie Type C / IP 40 In-63A



BESTELNUMMER N° DE COMMANDE	MOD.	Afm. Dim.
N4-C	1 x 4	232x139x99 mm
N8-C	1 x 8	215x236x112 mm
N12-C	1 x 12	287x236x112 mm
N18-C	1 x 18	396x236x112 mm
N24-C	2 x 12	287x361x112 mm
N36-C	3 x 12	287x485x112 mm
N2x18-C	2 x 18	396x361x112 mm
N3x18-C	3 x 18	396x526x112 mm
N48-C	4 x 12	287x651x112 mm
N4x18-C	4 x 18	651x396x112 mm

Din rail en aardingsrail inclusief en geïnstalleerd
Rail Din et barrette de terre pré-installé



Verdeelkasten inbouw Type C / IP 40 In-63A

Coffrets de distribution à encastrer Type C / IP 40 In-63A



BESTELNUMMER N° DE COMMANDE	MOD.	Afm. Dim.
U8-C	1 x 8	211x232x99 mm
U12-C	1 x 12	283x232x106 mm
U18-C	1x 18	392x232x106 mm
U24-C	2 x 12	283x357x106 mm
U36-C	3 x 12	283x482x106 mm
U2x18-C	2 x 18	392x357x106 mm
U3x18-C	3 x 18	392x522x106 mm
U4-C	1 x 4	211 x 232 x 99 mm

Din rail en aardingsrail inclusief en geïnstalleerd
Rail Din et barrette de terre pré-installé



VERDEELKASTEN COFFRETS DE DISTRIBUTION

Slot voor verdeelkasten

Serrure pour coffrets de distribution



BESTELNUMMER N° DE COMMANDE	Specificiteit Spécificités
LOCKC-M	Serie C



Verdeelkasten opbouw Type D / IP 65 In-63A

Coffrets de distribution en saillie Type D / IP 65 In-63A



BESTELNUMMER N° DE COMMANDE	MOD.	Afm. Dim.
N4-D	1 x 4	127x200x120 mm
N8-D	1 x 8	200x200x120 mm
N12-D	1 x 12	318x258x142 mm
N24-D	2 x 12	318x383x142 mm
N36-D	3 x 12	318x507x142 mm
N48-D	4 X 12	

Din rail en aardingsrail inclusief en geïnstalleerd
Rail Din et barrette de terre pré-installé



Vijs voor verdeelkas

Vis pour coffret de distribution



Vijs voor serie C en D
Vis pour serie C et D



VERDEELKASTEN COFFRETS DE DISTRIBUTION

Slot voor verdeelkasten

Serrure pour coffrets de distribution



BESTELNUMMER N° DE COMMANDE	Specificiteit Spécificités
LOCKD-M	Serie D



Installatieset voor verdeelkast

Set d'installation pour coffret de distribut



BESTELNUMMER N° DE COMMANDE	
NSET-C-D	1

Installatie/vervangset voor serie C en D
Set d'installation/remplacement pour serie C et D



Verdeelkasten opbouw Type NEO / IP 65 In-100A

Coffrets de distribution en saillie Type NEO / IP 65 In-100A



BESTELNUMMER N° DE COMMANDE	MOD.	Afm. Dim.
RH18S	1 x 18	435x260x138 mm
RH36/2S	2 x 18	435x420x138 mm
RH54/3S	3 x 18	435x580x138 mm
RH72/4S	4 x 18	435x780x138 mm

Din rail en aardingsrail inclusief en geïnstalleerd
Rail Din et barrette de terre pré installé



Slot voor verdeelkasten

Serrure pour coffrets de distribution



BESTELNUMMER N° DE COMMANDE	Specificiteit Spécificités
36.81	Serie NEO



VERDEELKASTEN COFFRETS DE DISTRIBUTION

Verdeelkasten opbouw IP 55 Incl. din rail

Coffrets de distribution en saillie IP 55



BESTELNUMMER N° DE COMMANDE	Ingangen Entrées	MOD.	Afm. Dim.
250-5AM	6xM20+4xM25	4 + 1	95x162x122 mm
250-9AM	6xM20+4xM25	8 + 1	98x162x202 mm
250-11AM	10xM25	10 + 1	109x232x182 mm
250-9B	10 x PG21 met Nippels	8+1	98 X 162 X 202 mm



Afdekplaatjes voor MCB - Wit - 12 modulen

Couvercles universels pour MCB - Blanc - 12 modules



BESTELNUMMER N° DE COMMANDE	Afm. Dim.	
273MF	200x52x8 mm	10



Stopcontact voor borden - DIN Rail 35 mm

Prise de courant pour tableau - DIN Rail 35mm



BESTELNUMMER N° DE COMMANDE	Stroomsterkte Ampérage	SPANNING TENSION	
C500	16A	230V	1/5

VDE -EN 50 0 22



VERDEELKASTEN COFFRETS DE DISTRIBUTION

Kabeldoorvoer Quickseal M32

Cable transit Quickseal M32

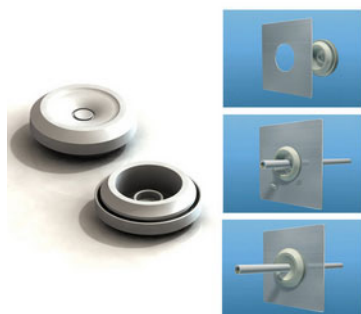

BESTELNUMMER N° DE COMMANDE	Afm. Dim.	
TPQSM32	M32	10/100



VLOERDOZEN BOÏTE POUR SOL

Vloerdozen voor toebehoren 45 x 45

Boîtes sol pour accessoires 45 x 45



BESTELNUMMER N° DE COMMANDE	MOD.	Afm. Dim.
745-4C LG	4	146x250x56 mm
745-8C LG	8	250x250x56 mm
745-CRF748	4 - 8	*

* Inlegstuk Voor Beton Voor Vloerdozen 4 En 8 Modules

* Piece d'Encastrement Pour Beton Pour Les Boîtes Sol 4 Et 8 Modules



Kader voor vloerdoos voor gebruik in beton / chape

Cadre pour boîte sol pour chape de béton



BESTELNUMMER N° DE COMMANDE
CFR748



Dubbele afdekplaat + 2 stekkers RJ45 CAT 6

Plaque double + 2 connecteurs RJ45 CAT6



BESTELNUMMER N° DE COMMANDE	Specificiteit Spécificités
745-LAN	CAT 6



SNELVERBINDERS CONNECTEURS RAPIDES

Universele steekklemmen

Raccords universels



BESTELNUMMER N° DE COMMANDE	
SDKF2TR-AN	100 / 2000
SDKF3TR-AN	75 / 1500
SDKF5TR-AN	50 / 1000



Stekklemmen voor harde draad

Raccords pour fil rigide



BESTELNUMMER N° DE COMMANDE	
SDK3	100 / 2000
SDK5	100 / 2000
SDK8	100 / 1000



Lusterklemmen

Raccords lustre



BESTELNUMMER N° DE COMMANDE	Ø	
50704	2,5 - 4 mm ²	10/500
50706	6 mm ²	10/250
50710	10 mm ²	10/250
50716	16 mm ²	10/100
50725	25 mm ²	10/50

24A , 450V, CE, HF, PP
Wit / Blanc



SNELVERBINDERS CONNECTEURS RAPIDES

Klemstenen

Barrettes de connection



BESTELNUMMER N° DE COMMANDE	Specificiteit Spécificités	
397-5	*1	20
397-3A	*1	20
398-5	*2	20
399-5	*3	10

*1 Voor / Pour : 220A / 220B / 222A / 222B / 222L

*2 Voor / Pour : FE25 / FE7 / FE12

*3 Voor / Pour : BOX LINE



BLACK & WHITE BLACK & WHITE

Eindstuk

Embout



BESTELNUMMER N° DE COMMANDE	Afm. Dim.	
EC20 Black	20 mm	100 / 5500
EC20 White	20 mm	100 / 5500

Black = RAL 9004

White = RAL 9003



PVC Stop

Bouchon PVC



BESTELNUMMER N° DE COMMANDE	Afm. Dim.	
907M20 Black	20 mm	50 / 2000

Black = RAL 9004



Buisinvoer

Entrée tube



BESTELNUMMER N° DE COMMANDE	Afm. Dim.	
MIBR1620 Black	16/20 mm	50 / 2000
MIBR1620 White	16/20 mm	50 / 2000

White = RAL 9003

Black = RAL 9004



BLACK & WHITE BLACK & WHITE

Mof

Manchon



BESTELNUMMER N° DE COMMANDE	Afm. Dim.	
U408 White	20 mm	50 / 1600
U408 Black	20 mm	100 / 1600
U409 Black	25 mm	25 / 1125

White = RAL 9003
Black = RAL 9004



Veerkleem Black & White

Attache ressort Black & White



BESTELNUMMER N° DE COMMANDE	Afm. Dim.	
204 White	20 mm	100 / 3000
204 Black	20 mm	100 / 3000
208 Black	25 mm	50 / 1500

White = RAL 9003
Black = RAL 9004



Aaneenschuifbare drukklemmen

Attaches à pression à juxtaposer



BESTELNUMMER N° DE COMMANDE	Afm. Dim.	
2036 Black	12 - 20 mm	50 / 1500
2037 Black	16 - 24 mm	50 / 1500

Black = RAL 9004



BLACK & WHITE BLACK & WHITE

Nagelclips - Platte Kabel - Wit

Attaches à clouer - câble plat - Blanc



BESTELNUMMER N° DE COMMANDE	∅	
702-2W	2 x 1,5	100



Nagelclips - maten in mm

Attaches à clouer - mesures en mm



BESTELNUMMER N° DE COMMANDE	∅	
3007-18Black	7 mm*	100 / 12800

De 2 laatste cijfers van het bestelnummer duiden de lengte van de nagel aan. Kleur: Grijs

Les 2 derniers chiffres du n° de commande indiquent la longueur du clou. Couleur: Gris

*Zwart / Noire



Wartel

Presse-étoupe



BESTELNUMMER N° DE COMMANDE	Afm. Dim.	
BM20 White	20 mm	50 / 2000
BM20 Black	20 mm	50 / 2000

White = RAL 9003

Black = RAL 9004



BLACK & WHITE BLACK & WHITE

Boxline kabeldoos schroefingangen M20

Boxline boîte de dérivation filetage M20



BESTELNUMMER N° DE COMMANDE	Ingangen Entrées	∅	Afm. Dim.	
J100S Black	7	M20	102 ² x56 mm	1 / 90
J100S White	7	M20	102 ² x56 mm	1 / 90

White = RAL 9003

Black = RAL 9004



Kabeldoos thermoplast

Boîte de dérivation thermoplastique



BESTELNUMMER N° DE COMMANDE	Ingangen Entrées	Afm. Dim.	
FE25 Black	10	89 x 43 x 37 mm	10 / 150
FE25 White	10	89 x 43 x 37 mm	10 / 150
FE7 Black	7	75x75x37	10/300

Black = RAL 9004

White = RAL 9010

∅ 1,5-4mm



WARTELS PRESSE-ETOUPES

Wartels - Pg reeks

Presse-étoupes - Série Pg



BESTELNUMMER N° DE COMMANDE	∅	
90507	PG7	50
90509	PG9	50 / 3750
90511	PG11	50 / 2700
90513	PG13,5	50 / 2700
90516	PG16	50 / 1850
90521	PG21	20 / 1080
90529	PG29	20 / 440
90536	PG36	10 / 220
90548	PG48	5

Polystyrol

Schokbestendig / Résistant au choc

Wurtring in rubber / Bague d'échanchéité en caoutchouc

Drukrondeel in gegalvaniseerd ijzer / Rondelle de pression en acier galvanisé

IP 65 – 5°C à + 60°C



Wartels met trekcontlasting - Pg reeks

Presse-étoupes à serrage - Série Pg



BESTELNUMMER N° DE COMMANDE	∅	
9707-ORL01	PG7	100
9709-ORL02	PG9	100
9711-ORL03	PG11	100
9713-ORL04	PG13,5	100
9716-ORL05	PG16	50
9721-ORL06	PG21	50
9729-ORL07	PG29	25
9736-ORL08	PG36	10
9748-ORL10	PG48	5

Polyamide met TPE rubber / Bague TPE

IP 68 –30°C à + 80°C



WARTELS PRESSE-ETOUPES

Tegenmoeren - Pg reeks

Contre-écrous - Série Pg



BESTELNUMMER N° DE COMMANDE	∅	
90607	PG7	50
90609	PG9	50
90611	PG11	50
90613	PG13,5	50 / 5600
90616	PG16	50 / 5600
90621	PG21	20 / 2240
90629	PG29	20 / 2240
90636	PG36	10
90648	PG48	10

Polystyrol / Polystyrene
Schokbestendig / Résistant au choc
- 5°C à + 60°C
DIN 46320 - L



Stoppen - Pg reeks

Bouchons - Série Pg



BESTELNUMMER N° DE COMMANDE	∅	
90707	PG7	100
90709	PG9	100
90711	PG11	100
90713	PG13,5	50
90716	PG16	50
90721	PG21	50
90729	PG29	50
90736	PG36	50
90748	PG48	25

Polystyrol / Polystyrene
Schokbestendig / Résistant au choc
- 5°C à + 60°C
DIN 46320 - N



WARTELS PRESSE-ETOUPES

Wartels - Metrische reeks

Presse-étoupes - Série Métrique IP54



BESTELNUMMER N° DE COMMANDE	∅	
905M12-DMRL01	12 mm	50
905M16-DMRL03	16 mm	50
905M20-DMRL04	20 mm	100
905M25-DMRL06	25 mm	50

Polyamide / IP 54 / -30°C /+80°C,
TPV Rubber / Bague TPV, EN60423



Wartels met trekontlasting - Metrische reeks IP68

Presse-étoupes à serrage - Série Métrique IP68



BESTELNUMMER N° DE COMMANDE	∅	
BM12	12 mm	50 / 2000
BM16	16 mm	50 / 2000
BM20	20 mm	50 / 2000
BM25	25 mm	20 / 800
BM32	32 mm	20 / 600
BM40	40 mm	10 / 300
BM50	50 mm	5 / 200
BM63	63 mm	5 / 120

Met skintop en trekontlasting
Avec skintop et serrage étendu
Polyamide / IP 68 / -20°C /+125°C



Wartels MULTIHOLE met trekontlasting - Metrische reeks IP65

Presse-étoupes MULTIHOLE à serrage - Série Métrique IP6

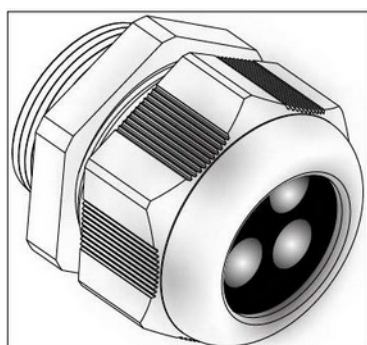

BESTELNUMMER N° DE COMMANDE	∅	RAL
OMRL05A7	M20	RAL7035

IP65, -30°C /+80°C, RAL7035



WARTELS PRESSE-ETOUPES

Wartels met trekcontlasting

Presse-étoupes à serrage - Série Métrique



BESTELNUMMER N° DE COMMANDE	∅	
OMRL03 M16	M16 (5-10 mm)	150 / 2500
OMRL05 M20	M20 (10-14 mm)	150 / 2500
OMRL09 M50	M50	100 / 1600
OMRL10 M63	M63	100 / 1600

Polyamide / IP 68
 -30°C / +80°C,
 TPV Rubber / Bague TPV, EN50262, RAL7035, VDE
 RAL7035
 Einde Reeks/Fin de série



Tegenmoeren - Metrische reeks

Contre-écrous - Série Métrique



BESTELNUMMER N° DE COMMANDE	∅	
PM12	12 mm	50/4800
PM16	16 mm	50/4800
PM20	20 mm	50/4800
PM25	25 mm	20/1920
PM32	32 mm	20/1920
PM40	40 mm	10/960
PM50	50 MM	10/480
PM63	63 MM	5/480

Polyamide
 RAL7035
 - 20°C / +125°C



Tegenmoeren - Metrische reeks

Contre-écrous - Série Métrique



BESTELNUMMER N° DE COMMANDE	∅
OMSL01	12 mm
OMSL02	16 mm

Polyamide (30% Glassfiber)
 RAL7035
 - 30°C / +80°C



WARTELS PRESSE-ETOUPES

Tegenmoeren - Metrische reeks

Contre-écrous - Série Métrique



BESTELNUMMER N° DE COMMANDE	∅
OMSL03	20 mm
OMSL04	25 mm
OMSL05	32 mm
OMSL06	40 mm
OMSL07	50 mm
OMSL08	63 mm

Polyamide (30% Glassfiber)

RAL7035

- 30°C / +80°C



Stoppen - Metrische reeks

Bouchons - Série Métrique



BESTELNUMMER N° DE COMMANDE	∅	
907M12	12 mm	100
907M16	16 mm	100
907M20	20 mm	100
907M25	25 mm	25
907M32	32 mm	20
907M40	40 mm	10
907M50	50 mm	4
907M63	63 mm	4

Polyamide

RAL7035

- 30°C / +80°C



Wurgnippels - Metrische reeks

Raccords à visser - Série Métrique



BESTELNUMMER N° DE COMMANDE	∅	
908M16	16 mm	100

Polyamide

RAL7035

- 30°C / +80°C



WARTELS PRESSE-ETOUPES

Wurgnippels - Metrische reeks

Raccords à visser - Série Métrique



BESTELNUMMER N° DE COMMANDE	∅	
908M20	20 mm	100
908M25	25 mm	100
908M32	32 mm	50
908M40	40 mm	25
908M50	50 mm	10

Polyamide
RAL7035
- 30°C / +80°C



Drukmoeren - Metrische reeks

Boulons de pression - Série Métrique



BESTELNUMMER N° DE COMMANDE	∅	
909M16	16 mm	100
909M20	20 mm	100



Vergrotingen - Metrische reeks

Augmentations - Série Métrique



BESTELNUMMER N° DE COMMANDE	∅ BINNEN ∅ NTERNE	∅	
ME1216	M16	M12	100
ME1620	M20	M16	100
ME2025	M25	M20	100
ME2532	M32	M25	50
ME3240	M40	M32	50

Polystyrol / IP 65 / - 5°C / + 60°C



WARTELS PRESSE-ETOUPES

Verkleiningen - Metrische reeks

Réductions - Série Métrique



BESTELNUMMER N° DE COMMANDE	∅ BINNEN ∅ NTERNE	∅	
MR1612	M12	M16	100
MR2012	M12	M20	100
MR2016	M16	M20	100
MR2512	M12	M25	100
MR2516	M16	M25	100
MR2520	M20	M25	100
MR3212	M12	M32	50
MR3216	M16	M32	50
MR3220	M20	M32	50
MR3225	M25	M32	50
MR4016	M16	M40	50
MR4020	M20	M40	50
MR4025	M25	M40	50
MR4032	M32	M40	50
MR5020	M20	M50	25
MR5025	M25	M50	25
MR5032	M32	M50	25
MR5040	M40	M50	25
MR6325	M25	M63	25
MR6332	M32	M63	25
MR6340	M40	M63	25
MR6350	M50	M63	25



SUPER T SUPER T

Aaneenschuifbare klem SUPER T

Attache à juxtaposer SUPER T



BESTELNUMMER N° DE COMMANDE	∅	
ST-16	16 mm	100/3000
ST-20	20 mm	100/3000
ST-25	25 mm	100/3000
ST-32	32 mm	100/3000
ST-40	40 mm	50/1500

M6 Polyamide

Kleur : grijs

Couleur : gris



Deksel voor SUPER T

Couvercle pour SUPER T



BESTELNUMMER N° DE COMMANDE	Afm. Dim.	
STC-16	16 mm	100/9600
STC-20	20 mm	100/9600
STC-25	25 mm	100/9600
STC-32	32 mm	100/9600
STC-40	40 mm	50/4800



Plug M6 voor veer- en drukklemmen

Cheville M6 pour attaches ressort et à pression



BESTELNUMMER N° DE COMMANDE	
20436	100

M6 Polyamide

Kleur : grijs

Couleur : gris

3 posities / 3 positions



SUPER T SUPER T

Plug M6 voor veer- en drukklemmen

Duimplug M6 voor klem SUPER T

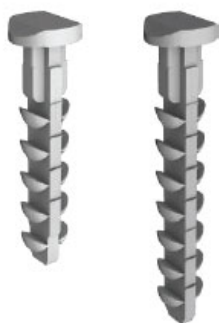

BESTELNUMMER N° DE COMMANDE	Specificiteit Spécificités	
PST-5	27 mm	100/9600
PST-7	42 mm	100/9600

M6 Polyamide
Kleur : grijs
Couleur : gris
1 positie / 1 position



Montageplug M6 voor beton voor klem SUPER T

Cheville de montage M6 pour béton pour SUPER T

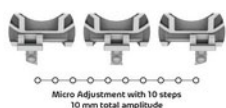

BESTELNUMMER N° DE COMMANDE	Afm. Dim.	
PSTB-4	27 mm	100/9600
PSTB-7	42 mm	100/9600

M6 Polyamide
Kleur : grijs
Couleur : gris
10 posities / 10 positionS



Montageplug voor metalen plaat voor klem SUPER T

Cheville de montage pour plaque de métal pour SUPER T

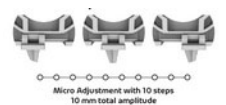

BESTELNUMMER N° DE COMMANDE	
ST-CLIP	100/14400

Polyamide
Kleur : grijs
Couleur : gris
10 posities / 10 positionS
Ook voor kabelbinders / aussi pour colliers de câblage



SUPER T SUPER T

Montageplug voor gebruik met siliconen voor klem SUPER T

Cheville de montage pour usage avec silicones pour SUPER T

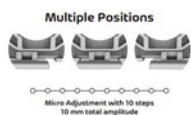
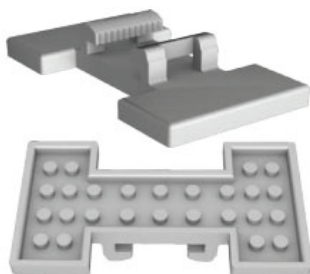

BESTELNUMMER
N° DE COMMANDE



ST-BASE

100/9600

Polyamide

Kleur : grijs

Couleur : gris

10 posities / 10 positionS

Ook voor kabelbinders / aussi pour colliers de câblage



VEERKLEMMEN ATTACHES RESSORT

veerklemmen

Attaches ressort



BESTELNUMMER N° DE COMMANDE	∅	
108	50 mm	25 / 600

M6 Polyamide
Kleur : grijs
Couleur : gris



Aaneenschuifbare veerklemmen

Attaches ressort à juxtaposer



BESTELNUMMER N° DE COMMANDE	∅	
211	16 mm	100 / 4000
204	20 mm	100 / 3000
208	25 mm	50 / 1500
209	32 mm	50 / 1500
210	40 mm	25 / 750

M6 Polyamide
Kleur : grijs
Couleur : gris



Aaneenschuifbare drukklemmen

Attaches pression à juxtaposer



BESTELNUMMER N° DE COMMANDE	∅	
2035	6 - 13 mm	50 / 3750
2036	12 - 20 mm	50 / 1500
2037	16 - 24 mm	50 / 1500
2038	18 - 30 mm	50 / 1200
2039	27 - 43 mm	25 / 750

M6 Polyamide
Kleur : grijs
Couleur : gris



VEERKLEMMEN ATTACHES RESSORT

Universele klemmen Attaches universelles



BESTELNUMMER N° DE COMMANDE	∅	
031G	16 - 22 mm	50 / 2700
031T	16 - 22 mm	50 / 2700

Kleur : Grijs of transparant
Couleur : Gris ou transparent



Veerkleem met Plug M6 Attache Ressort avec Cheville M6

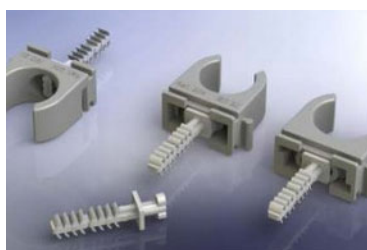

BESTELNUMMER N° DE COMMANDE	∅	
204 D	16 mm	50/2000
211 D	20 mm	100/4000

M6 Polyamide
Kleur : grijs
Couleur : gris



Drukklem met Plug M6 Attaches pression avec Cheville M6



BESTELNUMMER N° DE COMMANDE	∅	
2036 D	12 - 20 mm	50 / 1500
2037 D	16 - 24 mm	50 / 1200

M6 Polyamide
Kleur : grijs
Couleur : gris



KLEMMEN ATTACHES

Vorkklemmen

Attaches fourchette



BESTELNUMMER N° DE COMMANDE	∅	
512	10 mm	100/1000
513	12 mm	100/1000
514	13,5 - 15 mm	100/5400
515	14 - 15 mm	100/1000
516	16 - 18 mm	50/2500
517	20 - 22 mm	50/2500
518	22 - 25 mm	50/2700
519	35 mm	30/1080
520	42 mm	20/720

M6 Polyamide
Grijs / gris



Vorkklemmen dubbel

Attaches fourchette double



BESTELNUMMER N° DE COMMANDE	∅	
512-2	10 mm	50/500
513-2	12 mm	50/1000
515-2	14 - 15 mm	50/1000
516-2	16 - 18 mm	25/1350
517-2	20 - 22 mm	25/1350
518-2	25 - 28 mm	20/720

Voor gelijktijdige bevestiging van 2 kabels of buizen

Pour fixation simultane de 2 cables ou tubes

M6 Polyamide

Grijs / gris



KZM kabelzadels

KZM attaches



BESTELNUMMER N° DE COMMANDE	∅	
905	5 - 14 mm	100/4000

Polypropyleen/Polypropylène

Vijs in polystyrol/Vis en polystyrol



KLEMMEN ATTACHES

KZM kabelzadels

KZM attaches



BESTELNUMMER N° DE COMMANDE	∅	
906	6 - 17 mm	50/2000
907	15 - 25 mm	50/1200
908	24 - 34 mm	25/750

Polypropyleen/Polypropylène
Vijs in polystyrol/Vis en polystyrol



KZM kabelzadels dubbel

KZM attaches double



BESTELNUMMER N° DE COMMANDE	∅	
906-2	6 - 17 mm	50/1500

Polypropyleen/Polypropylène
Vijs in polystyrol/Vis en polystyrol



Slagklemmen

Attaches intercalaires



BESTELNUMMER N° DE COMMANDE	∅	
2047	5 - 25 mm	100 / 5400
2048	8 - 38 mm	100 / 3000

Snelle montage voor rail 761 & 2761
Fixation rapide pour rail 761 & 2761



Kabelhouder

Attaches câble

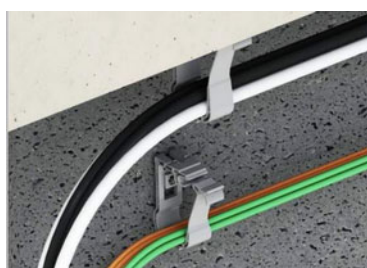

BESTELNUMMER N° DE COMMANDE	Normes	Afm. Dim.
710-15	Max. 10kg	38x69 mm
710-30	Max. 10kg	42x106 mm



KLEMMEN ATTACHES

Railklemmen

Attaches pour rail avec vis



BESTELNUMMER N° DE COMMANDE	∅	
2050	7 - 25 mm	100 / 5400
2051	13 - 38 mm	100 / 3000

Voor rail 761 & 2761

Pour rail 761 & 2761



Aaneenschuifbare 'Clic' klemmen

Attaches 'Clic' à juxtaposer



BESTELNUMMER N° DE COMMANDE	∅	
701516	15 - 16 mm	50/1350
701920	20 - 22 mm	50/900
702225	25 - 28 mm	50/400
703235	32 - 35 mm	50/800



SNELMONTAGE FIXATION RAPIDE

Universele nagelclips

Clips à clouer universels



BESTELNUMMER N° DE COMMANDE	∅	
700-02	2,5 - 4 mm	100 /12800
700-05	5 - 7 mm	100 /12800
700-08	8 - 10 mm	100 /9600
700-11	11 - 15 mm	100 /7500
700-16	16 - 19 mm	50 /2000
700-23	23 - 29 mm	50 /250
700-08 Black	5 - 7 mm *	100 /9600

Met slechts 6 types alle maten in voorraad. Kleur: Grijs
Avec seulement 6 types toutes dimensions en stock. Couleur: Gris
* Black



Nagelclips - maten in mm

Attaches en clouer - mesures en mm



BESTELNUMMER N° DE COMMANDE	∅	
3004-18	4 mm	100 /12800
3005-18	5 mm	100 /12800
3006-18	6 mm	100 /12800
3007-18	7 mm	100 /12800
3008-20	8 mm	100 /12800
3009-20	9 mm	100 /12800
3010-35	10 mm	100 /12800
3011-35	11 mm	100 /12800
3012-35	12 mm	50 / 6400
3014-40	14 mm	50 / 5400
3016-40	16 mm	25 / 3250
3018-40	18 mm	25 / 3200
3020-40	20 mm	25 / 3200
3007-18Black	7 mm*	100 /12800

De 2 laatste cijfers van het bestelnummer duiden de lengte van de nagel aan. Kleur: Grijs
Les 2 derniers chiffres du n° de commande indiquent la longueur du clou. Couleur: Gris
*Zwart / Noire



SNELMONTAGE FIXATION RAPIDE

Nagelclips - maten in mm

Attaches à clouer - mesures en mm



BESTELNUMMER N° DE COMMANDE	∅ BINNEN ∅ NTERNE	
OL70211	3/4 mm	100 /10000
OL70212	5/6 mm	100 /10000
OL70213	7/8 mm	100 /10000
OL70214	9/10 mm	100 /10000
OL70215	11/12 mm	100 /10000
OL70216	13/14 mm	100 /5000
OL70217	15/16 mm	100 /4000
OL70218	17/18 mm	100 /3000

De 2 laatste cijfers van het bestelnummer duiden de lengte van de nagel aan. Kleur: Grijs

Les 2 derniers chiffres du n° de commande indiquent la longueur du clou. Couleur: Gris



Nagelclips - Platte Kabel

Attaches à clouer - câble plat



BESTELNUMMER N° DE COMMANDE	∅	
702-0	2 x 0,75	100 /2000
702-1	2 x 1	100 /2000
702-2	2 x 1,5	100 /1000
702-3	2 x 2,5	100 /1000



Plugclips met nagel

Clips cheville avec clou



BESTELNUMMER N° DE COMMANDE	∅	
300620W	16 - 19 mm	200 / 3200
300720W	16 - 19 mm	100 / 1600



SNELMONTAGE FIXATION RAPIDE

Plugclips in PVC - Enkel

Clips cheville en PVC - Simple



BESTELNUMMER N° DE COMMANDE	Ingangen Entrées	∅	
601620	1	16 - 20 mm	200 / 6000
601922	1	19 - 22 mm	125 / 3750
602125	1	21 - 25 mm	125 / 3750

Snelle betonmontage / Fixation beton rapide

Kleur : wit / Couleur : blanc



Plugclips in PVC - Dubbel

Clips cheville en PVC - Double



BESTELNUMMER N° DE COMMANDE	Ingangen Entrées	∅	
611620	2	16 - 20 mm	125 / 3750
611922	2	19 - 22 mm	75 / 2250
612125	2	21 - 25 mm	60 / 1800

Snelle betonmontage / Fixation beton rapide

Kleur : wit / Couleur : blanc



Plugclips in PVC - dubbel

Clips cheville en PVC - Double



BESTELNUMMER N° DE COMMANDE	Ingangen Entrées	∅	
411620	2	16 - 20 mm	120 / 3600

Snelle betonmontage / Fixation beton rapide

Kleur : wit / Couleur : blanc



Pluggen

Chevilles



BESTELNUMMER N° DE COMMANDE	∅	
SEL712006	6 mm	100 / 4000
SEL712008	8 mm	100 / 2500
SEL712010	10 mm	50 / 1250
SEL712012	12 mm	25 / 625

SNELMONTAGE FIXATION RAPIDE

High cavity pluggen - met kraag

Chevilles à haute traction - avec collerette



BESTELNUMMER N° DE COMMANDE	∅	
SELRXO101	6 x 35 mm	100 / 1800
SELRXO102	8 x 50 mm	50 / 900

High cavity pluggen / Chevilles à haute traction

Nylon plug voor gipsplaten

Cheville Nylon pour plaques de plâtre



BESTELNUMMER N° DE COMMANDE	∅	
SELCGO101	12,3 x 29 mm	100 / 4000

Nylon plug met houtvijs kruis

Cheville Nylon avec visse en croix



BESTELNUMMER N° DE COMMANDE	∅	
SELPXV101	6 x 60 mm	100 / 900

Nylon slagplug kruis

Cheville Nylon à frapper



BESTELNUMMER N° DE COMMANDE	∅	
SELCXP102	5 X 30 mm	100 / 2000
SELCXP104	5 X 40 mm	100 / 2000
SELCXP106	6 x 40 mm	100 / 2000

KABELBINDERS COLLIERS DE CÂBLAGE

Zwart

Noir



BESTELNUMMER N° DE COMMANDE	Afm. Dim.	
SEL3201	75 x 2,5	100 / 5000
SEL3202	100 x 2,5	100 / 5000
SEL3203	135 x 2,5	100 / 5000
SEL3204	160 x 2,5	100 / 5000
SEL3205	200 x 2,5	100 / 5000
SEL3210	140 x 3,5	100 / 5000
SEL3211	200 x 3,5	100 / 5000
SEL3216	250 x 3,5	100 / 5000
SEL3212	280 x 3,5	100 / 5000
SEL3214	360 x 3,5	100 / 4000
SEL3220	140 x 4,5	100 / 5000
SEL3221	160 x 4,5	100 / 5000
SEL3222	180 x 4,5	100 / 5000
SEL3223	200 x 4,5	100 / 5000
SEL3224	250 x 4,5	100 / 5000
SEL3425	280 x 4,5	100 / 5000
SEL3429	300 x 4,5	100 / 4000
SEL3426	360 x 4,5	100 / 4000
SEL3427	380 x 4,5	100 / 3500
SEL3428	430 x 4,5	100 / 2500
SEL3447	360 x 6,0	100 / 1500
SEL3430	180 x 7,5	100 / 2500
SEL3431	240 x 7,5	100 / 2000
SEL3432	200 X 7,5	100 / 5000
SEL3433	280 x 7,5	100 / 2000
SEL3438	320 x 7,5	100 / 1500
SEL3434	360 x 7,5	100 / 1500
SEL2435	450 x 7,5	100 / 2500
SEL3436	500 x 7,5	100 / 1000
SEL3441	750 x 7,5	100 / 700
SEL3144	430 x 9,0	100 / 1000
SEL3142	550 x 9,0	100 / 700
SEL3143	780 x 9,0	100 / 500
SEL3155	1220 x 9,0	100 / 500

Nylon PA 6.6



KABELBINDERS COLLIERS DE CÂBLAGE

Zwart

Noir



BESTELNUMMER N° DE COMMANDE	Afm. Dim.	
SEL3150	250 x 12,5	50 / 500
SEL3451	500 x 12,5	50 / 500
SEL3452	750 x 12,5	50 / 500
SEL3453	1000 x 12,5	50 / 500

Nylon PA 6.6



Wit

Blanc



BESTELNUMMER N° DE COMMANDE	Afm. Dim.	
SEL2201	75 x 2,5	100 / 5000
SEL2202	100 x 2,5	100 / 5000
SEL2203	135 x 2,5	100 / 5000
SEL2204	160 x 2,5	100 / 5000
SEL2205	200 x 2,5	100 / 5000
SEL2210	140 x 3,5	100 / 5000
SEL2211	200 x 3,5	100 / 5000
SEL3215	225 x 3,5	100 / 5000
SEL2216	250 x 3,5	100 / 5000
SEL2212	280 x 3,5	100 / 5000
SEL2214	360 x 3,5	100 / 4000
SEL2220	140 x 4,5	100 / 5000
SEL2221	160 x 4,5	100 / 5000
SEL2222	180 x 4,5	100 / 5000
SEL2223	200 x 4,5	100 / 5000
SEL2224	250 x 4,5	100 / 5000
SEL2425	280 x 4,5	100 / 5000
SEL2429	300 x 4,5	100 / 4000
SEL2426	360 x 4,5	100 / 4000
SEL2427	380 x 4,5	100 / 3500
SEL2428	430 x 4,5	100 / 2500
SEL2447	360 X 6,0	50 / 500
SEL2430	180 x 7,5	100 / 2500

Nylon PA 6.6



KABELBINDERS COLLIERS DE CÂBLAGE

Wit
Blanc



BESTELNUMMER N° DE COMMANDE	Afm. Dim.	
SEL2432	200 x 7,5	100 / 5000
SEL2431	240 x 7,5	100 / 2000
SEL2433	280 x 7,5	100 / 2000
SEL2438	320 x 7,5	100 / 1500
SEL2434	360 x 7,5	100 / 1500
SEL2435	450 x 7,5	100 / 2500
SEL2436	500 x 7,5	100 / 1000
SEL3437	540 x 7,5	100 / 2500
SEL2441	750 x 7,5	100 / 700
SEL2144	430 x 9,0	100 / 1000
SEL2142	550 x 9,0	100 / 700
SEL2143	780 x 9,0	100 / 500
SEL2155	1220 x 9,0	100 / 500
SEL2450	250 x 12,5	50 / 500
SEL2451	500 x 12,5	50 / 500
SEL2452	750 x 12,5	50 / 500
SEL2453	1000 x 12,5	50 / 500

Nylon PA 6.6



KABELBINDERS COLLIERS DE CÂBLAGE

Kabelbinders gekleurd

Colliers de câblage colorés



Rood / Rouge RAL 3000
 Blauw / Bleu RAL 5002
 Groen / Vert RAL 6024
 Geel / Jaune RAL 1201
 Nylon PA 6.6



BESTELNUMMER N° DE COMMANDE	Afm. Dim.	KLEUR	COULEUR	
SEL.10.202R	100 x 2,5	Rood	Rouge	100 / 5000
SEL.10.210R	140 x 3,5	Rood	Rouge	100 / 5000
SEL.10.223R	200 x 4,5	Rood	Rouge	100 / 5000
SEL.10.425R	280 x 4,5	Rood	Rouge	100 / 5000
SEL.11.202R	100 x 2,5	Blauw	Bleu	100 / 5000
SEL.11.210R	140 x 3,5	Blauw	Bleu	100 / 5000
SEL.11.223R	200 x 4,5	Blauw	Bleu	100 / 5000
SEL.11.425R	280 x 4,5	Blauw	Bleu	100 / 5000
SEL.12.202R	100 x 2,5	Groen	Vert	100 / 5000
SEL.12.210R	140 x 3,5	Groen	Vert	100 / 5000
SEL.12.223R	200 x 4,5	Groen	Vert	100 / 5000
SEL.12.425R	280 x 4,5	Groen	Vert	100 / 5000
SEL.14.202R	100 x 2,5	Geel	Jaune	100 / 5000
SEL.14.210R	140 x 3,5	Geel	Jaune	100 / 5000
SEL.14.223R	200 x 4,5	Geel	Jaune	100 / 5000
SEL.14.425R	280 x 4,5	Geel	Jaune	100 / 5000

Kabelstrip wit - met markeerplaat 8 x 25 mm

Collier blanc - avec plaquette d'identification 8 x 25 mm



BESTELNUMMER N° DE COMMANDE	Afm. Dim.	
SEL.2.202T	100 x 2,5	100 / 5000

Nylon PA 6.6



KABELBINDERS COLLIERS DE CÂBLAGE

Centuring Polyamide 12

Centuring Polyamide 12



BESTELNUMMER N° DE COMMANDE	Afm. Dim.	
SEL3320	180 x 9	100 / 3500
SEL3321	265 x 9	100 / 2000
SEL3322	360 x 9	100 / 1400
SEL3323	500 x 9	100 / 1000
SEL3324	750 x 9	100 / 1000



Nylon binders met Inox tand - naturel

Colliers en nylon avec dent en acier Inox - naturel



BESTELNUMMER N° DE COMMANDE	Afm. Dim.	
MET22102R	100 x 2,5	100
MET22105R	200 x 2,5	100
MET22110R	140 x 3,5	100
MET22111R	200 x 3,5	100
MET22112R	280 x 3,5	100
MET22123R	200 x 4,5	100
MET22126R	360 x 4,5	100
MET22140R	290 x 4,5	100
MET22534R	360 x 7,5	100



Nylon binders met Inox tand - zwart

Colliers en nylon avec dent en acier Inox - noir



BESTELNUMMER N° DE COMMANDE	Afm. Dim.	
MET32102R	100 x 2,5	100
MET32105R	200 x 2,5	100
MET32110R	140 x 3,5	100
MET32111R	200 x 3,5	100
MET32112R	280 x 3,5	100
MET32123R	200 x 4,5	100
MET32126R	360 x 4,5	100
MET32326R	360 X 4,5	100



KABELBINDERS COLLIERS DE CÂBLAGE

Nylon binders met Inox tand - zwart

Colliers en nylon avec dent en acier Inox - noir



BESTELNUMMER N° DE COMMANDE	Afm. Dim.	
MET32140R	290 x 4,5	100
MET32534R	360 x 7,5	100



Click Tie - herbruikbaar - Rood

Click Tie - réouvrable et réutilisable - Rouge



BESTELNUMMER N° DE COMMANDE	Afm. Dim.	
CLT102110R	120 x 3,5	100 / 5000
CLT102116R	240 x 3,8	100 / 5000
CLT102129R	320 x 4,4	100 / 5000
CLT102149R	500 x 5,6	100 / 5000



Plug voor kabelbinders M8

Cheville pour colliers de serrage M8



BESTELNUMMER N° DE COMMANDE	
MF111	100 / 3500

Plug voor kabelbinders tot 9 mm breed.
Cheville pour collier de serrage jusqu'à 9 mm de largeur.



Zelfklevende 2-weg consoles

Consoles adhésives double direction



BESTELNUMMER N° DE COMMANDE	Afm. Dim.	
SEL2501	ø 20 mm	100 / 3000
SEL2502	ø 28 mm	100 / 3000



KABELBINDERS COLLIERS DE CÂBLAGE

Identificatieplaatje

Plaque d'identification



BESTELNUMMER N° DE COMMANDE	Afm. Dim.	
SEL101	20x40x1,3mm	100 / 3000



Klipconsoles 'Hooks' zelfklevend

Consoles clips 'Hooks' adhésifs



BESTELNUMMER N° DE COMMANDE	Afm. Dim.	
SEL2401	10 x 19	100 / 3000
SEL2402	13 x 26	100 / 3000
SEL2403	18 x 26	100 / 3000



PVC KANALEN CANAUX PVC

Type E - 6-6,5 mm - LSOH

Type E - 6-6,5 mm - LSOH

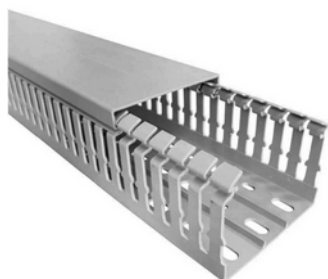

BESTELNUMMER N° DE COMMANDE	Afm. Dim.	
V6H2525	25 x 25 mm	50
V6H4025	25 x 40 mm	48
V6H4040	40 x 40 mm	50
V6H4060	60 x 40 mm	50
V6H4080	80 x 40 mm	30
V6H6025	25 x 60 mm	60
V6H6040	40 x 60 mm	40
V6H6060	60 x 60 mm	24
V6H6080	80 x 60 mm	20
V6H60100	100 x 60 mm	16
V6H60120	120 X 60 mm	12
V6H8025	25 x 80 mm	20
V6H8040	40 x 80 mm	20
V6H8060	60 x 80 mm	20
V6H8080	80 x 80 mm	12
V6H80100	100 x 80 mm	12
V6H80120	120 x 80 mm	16
V6H10060	60 x 100 mm	16
V6H10080	80 x 100 mm	16
V6H100100	100 x 100 mm	12

Lengte : 2 meter Kleur :
Grijs RAL 7035
Deksel inbegrepen
Longueur : 2 mètres
Couleur : Gris RAL 7035
Couvercle inclus



MINIKANALEN MINI GOULOTTE

TYPE INWAY LSOH

TYPE INWAY LSOH



BESTELNUMMER N° DE COMMANDE	Afm. Dim.	RAL	
IW20125LH	20 x 12,5 mm	RAL 9010	80m
IW2020LH	20 x 20 mm	RAL 9010	50m
IW4017LH	40 X 17 mm	RAL 9010	30m
IW6040LH	60 x 40 mm	RAL 9010	32m

Deksel inbegrepen
Lengte : 2 meter
Couvercle inclus
Longueur : 2 mètres



MINIKANALEN MINI GOULOTTE

Mini Inway - Toebehoren

Mini Inway - Accessoires



BESTELNUMMER N° DE COMMANDE	OMSC.	DESC.	Afm. Dim.
IWAE2012B	Buitenhoek	Angle extérieur	20 x 12,5 mm
IWAE4017B	Buitenhoek	Angle extérieur	40 x 17 mm
IWAI2012B	Binnenhoek	Angle intérieur	20 x 12,5 mm
IWAI4017B	Binnenhoek	Angle intérieur	40 x 17 mm
IWAP2012B	Vlakke hoek	Angle Plat	20 x 12,5 mm
IWAP4017B	Vlakke hoek	Angle Plat	40 x 17 mm
IWGT2012B	T	Dérivation "T"	20 x 12,5 mm
IWGT4017B	T	Dérivation "T"	40 x 17 mm
IWGU2012B	Koppelstuk	Joint	20 x 12,5 mm
IWGU4017B	Koppelstuk	Joint	40 x 17 mm
IWTT2012B	Eindstuk	Embout	20 x 12,5 mm
IWTT4017B	Eindstuk	Embout	40 x 17 mm



MINIKANALEN MINI GOULOTTE

TYPE INWAY BLACK LSOH

TYPE INWAY BLACK LSOH

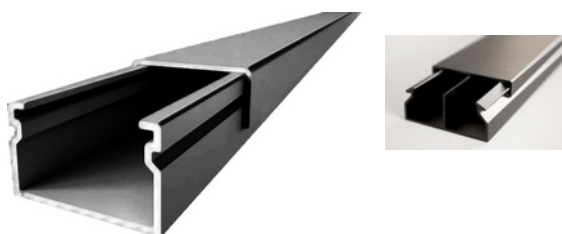

BESTELNUMMER N° DE COMMANDE	Afm. Dim.	RAL	
IW2012.5LHBlack	20 X 12,5 mm	RAL 9005	80 m
IW4017LHBlack	40 x 17 mm	RAL 9005	30 m

Deksel inbegrepen
Lengte : 2 meter
Couvercle inclus
Longueur : 2 mètres
OP AANVRAAG - SUR DEMANDE



MINIKANALEN MINI GOULOTTE

Mini Inway Black - Toebehoren

Mini Inway Black - Accessoires



BESTELNUMMER N° DE COMMANDE	OMSC.	DESC.	Afm. Dim.
IWAE2012Black	Buitenhoek	Angle extérieur	20 x 12,5 mm
IWAE4017Black	Buitenhoek	Angle extérieur	40 x 17 mm
IWAI2012Black	Binnenhoek	Angle intérieur	20 x 12,5 mm
IWAI4017Black	Binnenhoek	Angle intérieur	40 x 17 mm
IWAP2012Black	Vlakke hoek	Angle Plat	20 x 12,5 mm
IWAP4017Black	Vlakke hoek	Angle Plat	40 x 17 mm
IWGT2012Black	"T" stuk	Dérivation "T"	20 x 12,5 mm
IWGT4017Black	"T" stuk	Dérivation "T"	40 x 17 mm
IWGU2012Black	Koppelstuk	Joint	20 x 12,5 mm
IWGU4017Black	Koppelstuk	Joint	40 x 17 mm
IWTT2012Black	Eindstuk	Embout	20 x 12,5 mm
IWTT4017Black	Eindstuk	Embout	40 x 17 mm



LHD

LHD



BESTELNUMMER N° DE COMMANDE	Afm. Dim.	RAL	
LHD2010HF	20 x 10 mm	RAL 9003	96 m

Deksel inbegrepen

Lengte : 2 meter

Couvercle inclus

Longueur : 2 mètres

LIJST VAN DE TOEBEHOREN - ZIE WWW.GSV.BE

LISTE DES ACCESSOIRES - SUR WWW.GSV.BE



MINIKANALEN MINI GOULOTTE

LHD

LHD



BESTELNUMMER N° DE COMMANDE	Afm. Dim.	RAL	
LHD2020HF	20 x 20 mm	RAL 9003	48 m
LHD4020HF	40 x 20 mm	RAL 9003	24 m
LHD4040HF	40 x 40 mm	RAL 9003	20 m

Deksel inbegrepen

Lengte : 2 meter

Couvercle inclus

Longueur : 2 mètres

LIJST VAN DE TOEBEHOREN - ZIE WWW.GSV.BE

LISTE DES ACCESSOIRES - SUR WWW.GSV.BE



Buitenhoek

Angle extérieur



BESTELNUMMER N° DE COMMANDE	Afm. Dim.	
LHD8926HF	20 x 10 mm	1/10
LHD8626HF	20 x 20 mm	1/10
LHD8636HF	40 x 20 mm	1/10
LHD8646HF	40 x 40 mm	1/10



Binnenhoek

Angle intérieur



BESTELNUMMER N° DE COMMANDE	Afm. Dim.	
LHD8925HF	20 x 10 mm	1/10
LHD8625HF	20 x 20 mm	1/10
LHD8635HF	40 x 20 mm	1/10
LHD8645HF	40 x 40 mm	1/10
SAI160BEU	160 mm	1/10



MINIKANALEN MINI GOULOTTE

Vlakke hoek

Angle plat



BESTELNUMMER N° DE COMMANDE	Afm. Dim.	
LHD8923HF	20 x 10 mm	1/10
LHD8623HF	20 x 20 mm	1/10
LHD8633HF	40 x 20 mm	1/10
LHD8643HF	40 x 40 mm	1/10



T-stuk

Déviation-T



BESTELNUMMER N° DE COMMANDE	Afm. Dim.	
LHD8924HF	20 x 10 mm	1/10
LHD8624HF	20 x 20 mm	1/10
LHD8634HF	40 x 20 mm	1/10
LHD8644HF	40 x 40 mm	1/10



WANDKANALEN INWAY GOULOTTES INWAY

Wandkanalen LSOH

Goulotte LSOH

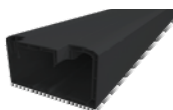

BESTELNUMMER N° DE COMMANDE	Afm. Dim.	RAL	
IW10054BLH	100 x 54 mm	RAL9003	12 m
IW10054LHBlack	100 x 54 mm	RAL9005	12 m

Deksel inbegrepen
Lengte : 2 meter
Couvercle inclus
Longueur : 2 mètres



WANDKANALEN INWAY GOULOTTES INWAY

Toebehoren Wandkanalen INWAY

Accessoires Goulottes Murales INWAY



BESTELNUMMER N° DE COMMANDE	OMSC.	DESC.	
IWAE10054B	Verstelbare buitenhoek	Angle extérieur flexible	6
IWAE10054Black	Verstelbare buitenhoek	Angle extérieur flexible	6
IWAI10054B	Verstelbare binnenhoek	Angle intérieur flexible	6
IWAI10054Black	Verstelbare binnenhoek	Angle intérieur flexible	6
IWAP10054B	Vlakke hoek	Angle plat	8
IWAP10054Black	Vlakke hoek	Angle plat	8
IWGT10054B	T-stuk	Déviation-T	6
IWGT10054Black	T-stuk	Déviation-T	6
IWGU100	Verbinding voor basis en deksel	Joint pour base et couvercle	100
IWGU100Black	Verbinding voor basis en deksel	Joint pour base et couvercle	100
IWS10040B	Scheidings:	Séparateur	8
IWS10040Black	Scheidings:	Séparateur	8
IWTT10054B	Eindstuk	Embout	12
IWTT10054Black	Eindstuk	Embout	12



CEE STEKKERS - IP67 PRISES CEE - IP67

Stekkers

Fiches mâles



BESTELNUMMER N° DE COMMANDE	Stroomsterk Ampérage	POLEN PÔLES	SPANNING TENSION	
679316-4	16 A	3	250 V	10
679416-4	16 A	4	415 V	10
679516-4	16 A	5	415 V	10
679332-4	32 A	3	250 V	10
679432-4	32 A	4	415 V	10
679532-4	32 A	5	415 V	10
679363-8	63 A	3	250 V	1
679463-8	63 A	4	415 V	1
679563-8	63 A	5	415 V	1

IP67



Koppelstekkers

Fiches femelles



BESTELNUMMER N° DE COMMANDE	Stroomsterk Ampérage	POLEN PÔLES	SPANNING TENSION	
679316-3	16 A	3	250 V	10
679416-3	16 A	4	415 V	10
679516-3	16 A	5	415 V	10
679332-3	32 A	3	250 V	10
679432-3	32 A	4	415 V	10
679532-3	32 A	5	415 V	10
679363-7	63 A	3	250 V	1
679463-7	63 A	4	415 V	1
679563-7	63 A	5	415 V	1

IP67



CEE STEKKERS - IP67 PRISES CEE - IP67

Wanddozen

Prises murales



BESTELNUMMER N° DE COMMANDE	Stroomsterk Ampérage	POLEN PÔLES	SPANNING TENSION	
679316-2	16 A	3	250 V	10
679416-2	16 A	4	415 V	10
679516-2	16 A	5	415 V	10
679332-2	32 A	3	250 V	10
679432-2	32 A	4	415 V	10
679532-2	32 A	5	415 V	10
679363-6	63 A	3	250 V	1
679463-6	63 A	4	415 V	1
679563-6	63 A	5	415 V	1

IP67



Inbouwdozen

Prises à encastrer



BESTELNUMMER N° DE COMMANDE	Stroomsterk Ampérage	POLEN PÔLES	SPANNING TENSION	
679316-1	16 A	3	250 V	10
679416-1	16 A	4	415 V	10
679516-1	16 A	5	415 V	10
679332-1	32 A	3	250 V	10
679432-1	32 A	4	415 V	10
679532-1	32 A	5	415 V	8
679363-5	63 A	3	250 V	2
679463-5	63 A	4	415 V	2
679563-5	63 A	5	415 V	2

IP67

5polen/poles = 3polen/poles + T + N

4polen/poles = 3polen/poles + T

3polen/poles = 2polen/poles + T



Fitting in thermoplast E27

Soquet thermoplastique E27



Kelderverlichtingen

Hublots



BESTELNUMMER N° DE COMMANDE	KLEUR	COULEUR	
755	Zwart	Noir	50 / 500



BESTELNUMMER N° DE COMMANDE	Specificiteit Spécificités	VERMOGEN PUISSANCE	
460	1	100 W	1/30
470	2	100 W	1/18
471	3	60 W	1/24

Voet : PVC

Glas : Polycarbonaat / onbreekbaar.

Pied : PVC

Verre : Polycarbonate / incassable



Brandwerende E90 Anti Feu E90

Brandwerende dozen E90 connectors incl.

Boîtes Anti Feu E90 connecteurs incl.



BESTELNUMMER N° DE COMMANDE	Ingang Entrées	ø	AFMENT DIMENSIE	VERPAK EMBAL.
J100BF	7*	M25	102x102	1
J100SF	6+1*	M20+M2	102x102	1
J160BF	10	M25	166x116	1
J200BF	10	M32	216x166	1

*Schroefingangen

*Entrées filetées

IP66 - Volgens - Selon DIN 4102-12 - Kema EN 60670-22

Keramische connector in steatiet inclusief

Connecteur ceramique en stéatite inclus



Wartel E90

Presse-étoupe E90



BESTELNUMMER N° DE COMMANDE	Normes	AFMENT DIMENSIE	VERPAK. EMBAL.
BM20LA	IP68	20 mm	50
BM25LA	IP68	25 mm	20



Keramische connector in steatiet

Connecteur ceramique en stéatite



BESTELNUMMER N° DE COMMANDE	Normes	ø	AFMENT DIMENSIE	VERPAK EMBAL.
J402	VDE	1,5-6mm	20X18X1 mm	1
J1602	VDE	1,5-10m	25x23x2 mm	1
J2021	VDE	1,5-16m	33x30x2 mm	1

Voor stijve en flexibele draad / Pour fil rigide et flexible
VDE gekeurd - certifiés VDE



FUNCTIEBEHOUD MAINTIEN DE FONCTION

FBB beugel, inclusief schroefanker - E90

Attache, cheville à visser incluse - E90

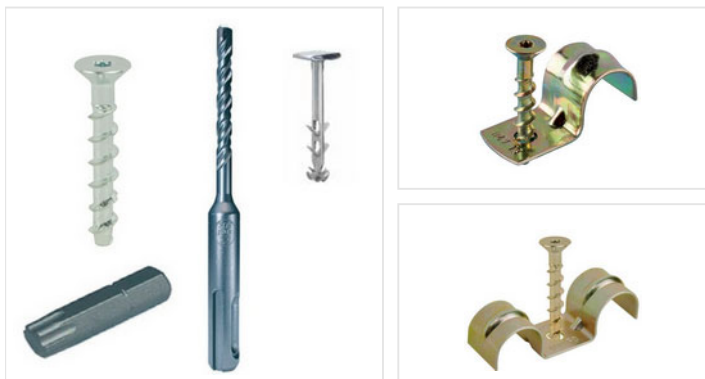

BESTELNUMMER N° DE COMMANDE	ø	VERPAK. EMBAL.
9700806	6 mm	200 / 800
9700808	8 mm	200 / 800
9700810	10 mm	200 / 800
9700812	12 mm	200 / 800
9700814	14 mm	150 / 600
9700816	16 mm	150 / 600
9700819	19 mm	150 / 600
9700825	25 mm	100 / 400
9702816	16 mm	75/300
9702819	19 mm	75/300
9700850	*1	
9700855	*2	
9700860	*3	
9230460	*4	

Per verpakking een SDS boor (torx bitje) inclusief

*1 Schroefanker - TSM

*2 Schroefbit - Torx 25 - 1/4"

*3 SDS functiebehoudboor - dia. 5x110

*4 Duimnagel E30 - E90 - E120

Une mèche SDS (torx) incluse par emballage

*1 Vis maintien de fonction - TSM

*2 nr 25 Embout de vissage - Torx 25 - 1/4"

*3 Mèche SDS - dia. 5x110

*4 Cheville à Pousser E30 - E90 - E120



FBB beugel, inclusief inslaganker - E90

Attache, cheville à frapper incluse - E90

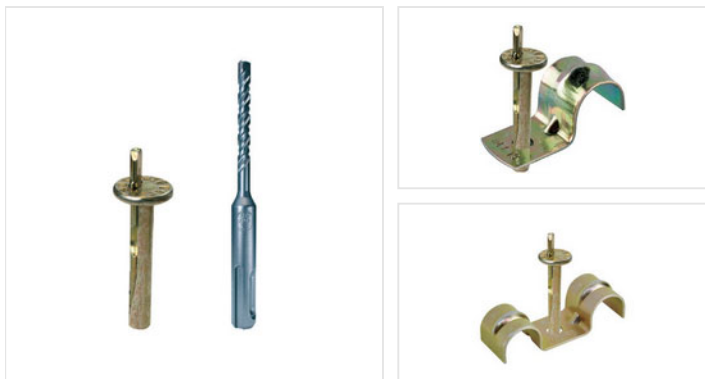

BESTELNUMMER N° DE COMMANDE	ø	VERPAK. EMBAL.
9700826	6 mm	200 / 800
9700828	8 mm	200 / 800
9700830	10 mm	200 / 800
9700832	12 mm	200 / 800

*1 SDS functiebehoudboor - dia. 6x110

*2 Inslaganker TDN 6/35

*1 Mèche SDS - dia. 6x110

*2 Cheville à frapper maintien de fonction TDN 6/35



FUNCTIEBEHOUD MAINTIEN DE FONCTION

FBB beugel, inclusief inslaganker - E90

Attache, cheville à frapper incluse - E90

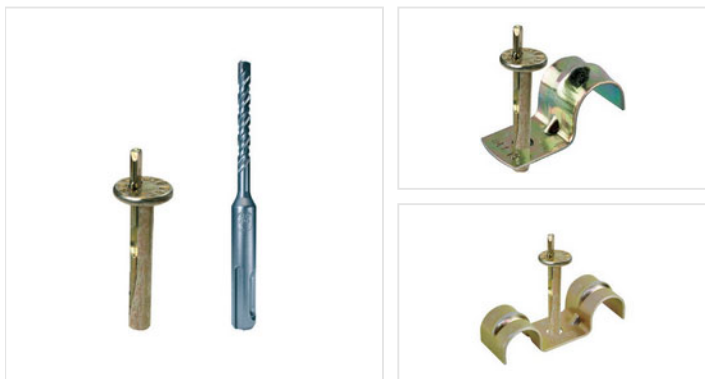

BESTELNUMMER N° DE COMMANDE	ø	VERPAK. EMBAL.
9700834	14 mm	150 / 600
9700836	16 mm	150 / 600
9700839	19 mm	150 / 600
9700845	25 mm	100 / 400
9702836	16 mm	75/300
9702839	19 mm	75/300
9700880	*2	
9700875	*1	

*1 SDS functiebehoudboor - dia. 6x110

*2 Inslaganker TDN 6/35

*1 Mèche SDS - dia. 6x110

*2 Cheville à frapper maintien de fonction TDN 6/35



FBB Beugel en Duim Nagel

Attache + cheville a Pousser maintien de fonction



BESTELNUMMER N° DE COMMANDE	OMSCH	DESCRI	ø	VERPAK. EMBAL.
9700817	Enkel	Simple	16 mm	150/ 600
9700820	Enkel	Simple	19 mm	150/ 600
9702817	Dubbel	Double	16 mm	150/ 600
9702820	Dubbel	Double	19 mm	150/ 600



Schroefanker met Plug met draad M10/M8

Vis à béton et cheville avec filetage interne M10/M8



BESTELNUMMER N° DE COMMANDE	VERPAK. EMBAL.
9401052	50



FUNCTIEBEHOUD MAINTIEN DE FONCTION

Klem voor buis en kabel met eenzijdige schuifbare sluiting

Collier pour câble et tube-fermeture unilatérale coulissante



BESTELNUMMER N° DE COMMANDE	∅	VERPAK. EMBAL.
5605-16	14-18 mm	100/1300
5605-22	19-23 mm	75/1200
5605-28	24-28 mm	50/1000
5605-38	30-38 mm	40/640
5605-50	39-52 mm	30/360
5605-60	53-61 mm	20/200

E90 (volgens/selon DIN 4102-12)

Ook / aussi : INOX



Verzamelbeugel Cable guide Functiebehoudbevestiging

Collier pour câbles à maintien de fonction



BESTELNUMMER N° DE COMMANDE	AFMENTINGEN DIMENSIONS	VERPAK. EMBAL.
9702845	74x73 mm	1/36

E30-E90



Inslaganker met kraag

Douilles de frappe avec colerette



BESTELNUMMER N° DE COMMANDE	AFMENTINGEN DIMENSIONS	VERPAK. EMBAL.
2014	M8	100
2016	M10	100
2012	M10	100



FUNCTIEBEHOUD MAINTIEN DE FONCTION

Slaganker met plug met draad M8/M10

Cheville à frapper et cheville avec filetage interne M10/M8



BESTELNUMMER N° DE COMMANDE	VERPAK. EMBAL.
9401051	100



Schroefanker met Plug met draad M10/M8

Vis à béton et cheville avec filetage interne M10/M8



BESTELNUMMER N° DE COMMANDE	VERPAK. EMBAL.
9401052	50



Inslaganker met kraag

Douilles de frappe avec colerette

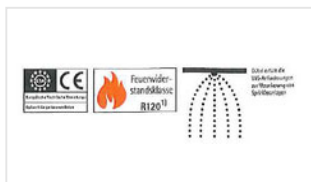

BESTELNUMMER N° DE COMMANDE	AFMENTINGEN DIMENSIONS	VERPAK. EMBAL.
2014	M8	100
2016	M10	100
2012	M10	100



Keilbout

Boulon expansible

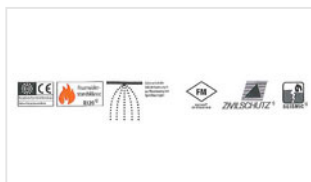

BESTELNUMMER N° DE COMMANDE	AFMENTINGEN DIMENSION	RAL	VERPAK. EMBAL.
4570	M8 x32		100



FUNCTIEBEHOUD MAINTIEN DE FONCTION

Brandwerend Schroefanker - MMS Plus

Vis à maintient de fonction - MMS Plus

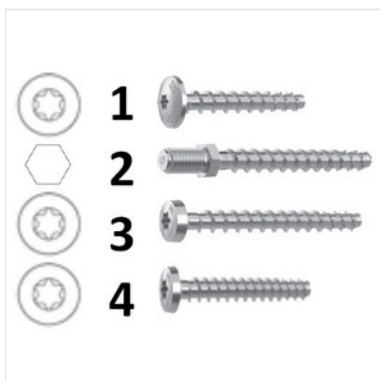

BESTELNUMMER N° DE COMMANDE	Specificiteit Spécificités	AFMETINGEN DIMENSIONS	VERPAK. EMBAL.
9421	1	MMS-PLUS MS 7.5X40	50
9422	2	MMS-PLUS ST 6.0X55	50
9423	3	MMS-PLUS P 6.0X50	50
9424	4	MMS-PLUS P 6.0X35	50



Ophangrail

Rail de suspension



BESTELNUMMER N° DE COMMANDE	AFMETINGEN DIMENSIONS	VERPAK. EMBAL.
9200900	15 x 30 mm	2/20 m

Sendzimir verzinkt staal/Acier galvanisé Sendzimir
Lengte/Longueur: 2m



METALEN KANALEN CHEMINS DE CÂBLE EN METAL

Draadgoten Easy Connect

Chemins de câble Easy Connect

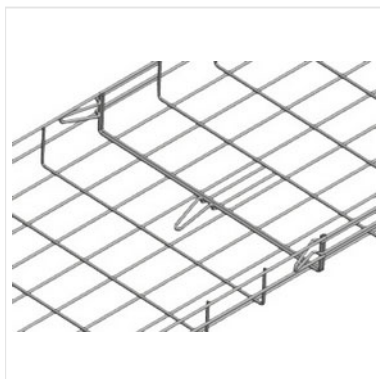

BESTELNUMMER N° DE COMMANDE	AFMENTINGEN DIMENSIONS	VERPAK. EMBAL.
EC60060EZ	60x060mm	36 / 1008 m
EC60100EZ	60x100mm	24 / 924 m
EC60150EZ	60x150mm	18 / 630 m
EC60200EZ	60x200mm	12/24/498 m
EC60300EZ	60x300mm	12 / 324 m
EC60400EZ	60x400mm	12 / 240 m
EC60500EZ	60x500mm	6 / 204 m
EC60600EZ	60x600mm	6 / 180 m

Standaard uitvoering / Finition standard
Quick Connection: met snelkoppeling / avec connexion rapide

LIJST VAN DE TOEBEHOREN - ZIE WWW.GSV.BE

LISTE DES ACCESSOIRES - SUR WWW.GSV.BE

Beschikbaar in RVS / Hot Deep Galvanised

Disponible en Inox /Hot Deep Galvanised



C - Beugel voor plafond

Fixation en C pour plafond



BESTELNUMMER N° DE COMMANDE	AFMENTINGEN DIMENSIONS	VERPAK. EMBAL.
SOPC10SG	180x115x215mm	8
SOPC15SG	180x115x265mm	8
SOPC20SG	180x115x315mm	8
SOPC30SG	180x115x415mm	8



L - beugel voor Wand

Fixation en L Murale

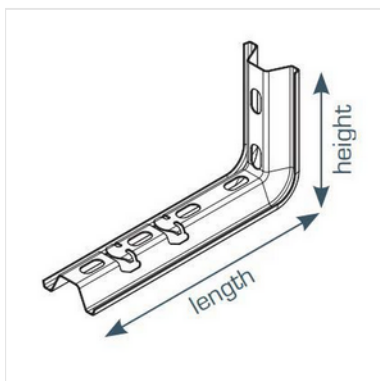

BESTELNUMMER N° DE COMMANDE	AFMENTINGEN DIMENSIONS	VERPAK. EMBAL.
SOC10SG	115x215mm	10
SOC15SG	115x265mm	10
SOC20SG	115x315mm	10
SOC30SG	115x415mm	10



METALEN KANALEN CHEMINS DE CÂBLE EN METAL

Snel Verbinder

Connecteur Rapide

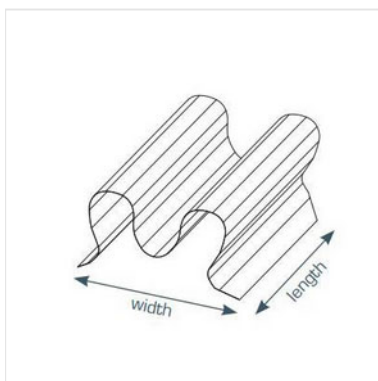

BESTELNUMMER N° DE COMMANDE	AFMENTINGEN DIMENSIONS	VERPAK. EMBAL.
MCLIC	13x23mm	100

Index Produit

0		3		6		9	
031G	38	3006-18	42	602125	44	905	39
031T	38	300620W	43	611620	44	90507	27
1		3007-18	42	611922	44	90509	27
108	37	3007-18Black	25, 42	612125	44	90511	27
2		300720W	43	679316-1	63	90513	27
2012	68, 69	3008-20	42	679316-2	63	90516	27
2014	68, 69	3009-20	42	679316-3	62	90521	27
2016	68, 69	3010-35	42	679316-4	62	90529	27
2035	37	3011-35	42	679332-1	63	90536	27
2036	37	3012-35	42	679332-2	63	90548	27
2036 Black	24	3014-40	42	679332-3	62	905M12-DMRL01 ..	29
2036 D	38	3016-40	42	679332-4	62	905M16-DMRL03 ..	29
2037	37	3018-40	42	679363-5	63	905M20-DMRL04 ..	29
2037 Black	24	3020-40	42	679363-6	63	905M25-DMRL06 ..	29
2037 D	38	316	14	679363-7	62	906	40
2038	37	318	14	679363-8	62	90607	28
2039	37	36.81	17	679416-1	63	90609	28
204	37	397-3A	22	679416-2	63	90611	28
204 Black	24	397-5	22	679416-3	62	90613	28
204 D	38	398-5	22	679416-4	62	90616	28
204 White	24	399-5	22	679432-1	63	906-2	40
20436	34	4		679432-2	63	90621	28
2047	40	411620	44	679432-3	62	90629	28
2048	40	424	13	679432-4	62	90636	28
2050	41	426	13	679463-5	63	90648	28
2051	41	428	13	679463-6	63	907	40
208	37	429	13	679463-7	62	90707	28
208 Black	24	430	13	679463-8	62	90709	28
209	37	430V	13	679516-1	63	90711	28
210	37	431	13	679516-2	63	90713	28
211	37	431V	13	679516-3	62	90716	28
211 D	38	4570	69	679516-4	62	90721	28
219B	7	460	64	679532-1	63	90729	28
220A	6	470	64	679532-2	63	90736	28
220AM	6	471	64	679532-3	62	90748	28
220B	7	5		679532-4	62	907M12	31
222A	6	50704	21	679563-5	63	907M16	31
222AM	6	50706	21	679563-6	63	907M20	31
222B	7	50710	21	679563-7	62	907M20 Black	23
223A	6	50716	21	679563-8	62	907M25	31
223AM	6	50725	21	7		907M32	31
223ATA	6	512	39	700-02	42	907M40	31
223ATAM	6	512-2	39	700-05	42	907M50	31
223B	7	513	39	700-08	42	907M63	31
223BTA	7	513-2	39	700-08 Black	42	908	40
223LTATR	9	514	39	700-11	42	908M16	31
224A	6	515	39	700-16	42	908M20	32
224AM	6	515-2	39	700-23	42	908M25	32
224B	7	516	39	701516	41	908M32	32
224LTR	9	516-2	39	701920	41	908M40	32
226B	7	517	39	702-0	43	908M50	32
250-11AM	18	517-2	39	702-1	43	909M16	32
250-5AM	18	518	39	702-2	43	909M20	32
250-9AM	18	518-2	39	702225	41	9200900	70
250-9B	18	519	39	702-2W	25	9230460	66
273MF	18	520	39	702-3	43	9401051	69
28.41	11	5605-16	68	702-3	43	9401052	67, 69
28.43	12	5605-22	68	703235	41	9421	70
28.43-PLEXI	12	5605-28	68	710-15	40	9422	70
28.51	11	5605-38	68	710-30	40	9423	70
28.53	12	5605-50	68	745-4C LG	20	9424	70
28.61	11	5605-60	68	745-8C LG	20	9700806	66
3		6		745-CRF748	20	9700808	66
3004-18	42	601620	44	745-LAN	20	9700810	66
3005-18	42	601922	44	755	64	9700812	66

Index Produit

9		C		I		J	
9700814	66	CLT102129R	51	IW10054BLH	60	J80L	7
9700816	66	CLT102149R	51	IW10054LHBlack	60	K	
9700817	67	E		IW2012.5LHBlack	56	KPZ1PO	13
9700819	66	E120	68, 69, 70	IW20125LH	54	L	
9700820	67	E60	68	IW2020LH	54	LHD2010HF	57
9700825	66	E90	13, 65, 66, 67, 68, 69, 70, 71	IW4017LH	54	LHD2020HF	58
9700826	66	EC16	5	IW4017LHBlack	56	LHD4020HF	58
9700828	66	EC16 R	5	IW6040LH	54	LHD4040HF	58
9700830	66	EC20	5	IWAE10054B	61	LHD8623HF	59
9700832	66	EC20 Black	23	IWAE10054Black	61	LHD8624HF	59
9700834	67	EC20 R	5	IWAE2012B	55	LHD8625HF	58
9700836	67	EC20 White	23	IWAE2012Black	57	LHD8626HF	58
9700839	67	EC25	5	IWAE4017B	55	LHD8633HF	59
9700845	67	EC25 R	5	IWAE4017Black	57	LHD8634HF	59
9700850	66	EC60060EZ	71	IWAI10054B	61	LHD8635HF	58
9700855	66	EC60100EZ	71	IWAI10054Black	61	LHD8636HF	58
9700860	66	EC60150EZ	71	IWAI2012B	55	LHD8643HF	59
9700875	67	EC60200EZ	71	IWAI2012Black	57	LHD8644HF	59
9700880	67	EC60300EZ	71	IWAI4017B	55	LHD8645HF	58
9702816	66	EC60400EZ	71	IWAI4017Black	57	LHD8646HF	58
9702817	67	EC60500EZ	71	IWAP10054B	61	LHD8923HF	59
9702819	66	EC60600EZ	71	IWAP10054Black	61	LHD8924HF	59
9702820	67	ECICTA20HF	3	IWAP2012B	55	LHD8925HF	58
9702836	67	ECICTA20HFT	3	IWAP2012Black	57	LHD8926HF	58
9702845	68	ECICTA25HF	3	IWAP4017B	55	LOCKC-M	16
9707-ORL01	27	ECICTA25HFT	3	IWAP4017Black	57	LOCKD-M	17
9709-ORL02	27	ERFE20G	3	IWGT10054B	61	M	
9711-ORL03	27	ERFE25G	3	IWGT10054Black	61	M001CS	11
9713-ORL04	27	F		IWGT2012B	55	M002CS	11
9716-ORL05	27	FE12	10	IWGT2012Black	57	M003CS	11
9721-ORL06	27	FE15	10	IWGT4017B	55	M005CS	11
9729-ORL07	27	FE25	10	IWGT4017Black	57	MCLIC	72
9736-ORL08	27	FE25 Black	26	IWGU100	61	ME1216	32
9748-ORL10	27	FE25 White	26	IWGU100Black	61	ME1620	32
B		FE7	10	IWGU2012B	55	ME2025	32
BM12	29	FE7 Black	26	IWGU2012Black	57	ME2532	32
BM16	29	H		IWGU4017B	55	ME3240	32
BM20	29	HF	2, 3, 4, 5, 6, 7, 8, 9, 10, 11, 12, 13, 14, 15, 16, 17, 18, 19, 20, 21, 22, 23, 24, 25, 26, 27, 28, 29, 30, 31, 32, 33, 34, 35, 36, 37, 38, 39, 40, 41, 42, 43, 44, 46, 47, 49, 50, 51, 52, 53, 54, 55, 56, 57, 58, 59, 60, 61, 62, 63, 64, 65	IWS10040B	61	MET22102R	50
BM20 Black	25			IWS10040Black	61	MET22105R	50
BM20 White	25			IWTT10054B	61	MET22110R	50
BM20LA	65			IWTT10054Black	61	MET22111R	50
BM25	29			IWTT2012B	55	MET22112R	50
BM25LA	65			IWTT2012Black	57	MET22123R	50
BM32	29			IWTT2012Black	57	MET22126R	50
BM40	29			IWTT4017B	55	MET22140R	50
BM50	29			IWTT4017Black	57	MET22534R	50
BM63	29			J		MET32102R	50
C				J100B	7	MET32105R	50
C16VD	4			J100BF	65	MET32110R	50
C16VD R	4			J100L	7	MET32111R	50
C20VD	4			J100S	6	MET32112R	50
C20VD R	4			J100S Black	26	MET32123R	50
C25VD	4			J100S CONNECTO	6	MET32126R	50
C25VD R	4			J100S White	26	MET32140R	51
C32VD	4			J100SF	65	MET32326R	50
C32VD R	4			J1602	65	MET32534R	51
C40VD	4			J160B	7	MF111	51
C40VD R	4			J160BF	65	MF242	9
C500	18			J160L	7	MIB16	8
C50VD	4			J200B	7	MIB21	8
C50VD R	4			J200BF	65	MIB29	8
CFR748	20			J200L	7	MIBR1620	5
CLT102110R	51			J2021	65	MIBR1620 Black	23
CLT102116R	51			J402	65	MIBR1620 White	23
				J80B	7	MR1612	33

Index Produit

M

MR2012	33
MR2016	33
MR2512	33
MR2516	33
MR2520	33
MR3212	33
MR3216	33
MR3220	33
MR3225	33
MR4016	33
MR4020	33
MR4025	33
MR4032	33
MR5020	33
MR5025	33
MR5032	33
MR5040	33
MR6325	33
MR6332	33
MR6340	33
MR6350	33

N

N12-C	15
N12-D	16
N18-C	15
N24-C	15
N24-D	16
N2x18-C	15
N36-C	15
N36-D	16
N3x18-C	15
N48-C	15
N48-D	16
N4-C	15
N4-D	16
N4x18-C	15
N8-C	15
N8-D	16
NEW	16, 17, 34, 35, 36
NSET-C-D	17
NVIS-C-D	16

O

OL70211	43
OL70212	43
OL70213	43
OL70214	43
OL70215	43
OL70216	43
OL70217	43
OL70218	43
OMRL03 M16	30
OMRL05 M20	30
OMRL05A7	29
OMRL09 M50	30
OMRL10 M63	30
OMSL01	30
OMSL02	30
OMSL03	31
OMSL04	31
OMSL05	31
OMSL06	31
OMSL07	31
OMSL08	31

P

PM12	30
PM16	30
PM20	30
PM25	30
PM32	30
PM40	30
PM50	30
PM63	30
PST-5	35
PST-7	35
PSTB-4	35
PSTB-7	35

R

RH18S	17
RH36/2S	17
RH54/3S	17
RH72/4S	17

S

SAI160BEU	58
SDK3	21
SDK5	21
SDK8	21
SDKF2TR-AN	21
SDKF3TR-AN	21
SDKF5TR-AN	21
SEL.10.202R	49
SEL.10.210R	49
SEL.10.223R	49
SEL.10.425R	49
SEL.11.202R	49
SEL.11.210R	49
SEL.11.223R	49
SEL.11.425R	49
SEL.12.202R	49
SEL.12.210R	49
SEL.12.223R	49
SEL.12.425R	49
SEL.14.202R	49
SEL.14.210R	49
SEL.14.223R	49
SEL.14.425R	49
SEL.2.202T	49
SEL101	52
SEL2142	48
SEL2143	48
SEL2144	48
SEL2155	48
SEL2201	47
SEL2202	47
SEL2203	47
SEL2204	47
SEL2205	47
SEL2210	47
SEL2211	47
SEL2212	47
SEL2214	47
SEL2216	47
SEL2220	47
SEL2221	47
SEL2222	47
SEL2223	47
SEL2224	47
SEL2401	52
SEL2402	52
SEL2403	52

S

SEL2425	47
SEL2426	47
SEL2427	47
SEL2428	47
SEL2429	47
SEL2430	47
SEL2431	48
SEL2432	48
SEL2433	48
SEL2434	48
SEL2435	46, 48
SEL2436	48
SEL2438	48
SEL2441	48
SEL2447	47
SEL2450	48
SEL2451	48
SEL2452	48
SEL2453	48
SEL2501	51
SEL2502	51
SEL3142	46
SEL3143	46
SEL3144	46
SEL3150	47
SEL3155	46
SEL3201	46
SEL3202	46
SEL3203	46
SEL3204	46
SEL3205	46
SEL3210	46
SEL3211	46
SEL3212	46
SEL3214	46
SEL3215	47
SEL3216	46
SEL3220	46
SEL3221	46
SEL3222	46
SEL3223	46
SEL3224	46
SEL3320	50
SEL3321	50
SEL3322	50
SEL3323	50
SEL3324	50
SEL3425	46
SEL3426	46
SEL3427	46
SEL3428	46
SEL3429	46
SEL3430	46
SEL3431	46
SEL3432	46
SEL3433	46
SEL3434	46
SEL3436	46
SEL3437	48
SEL3438	46
SEL3441	46
SEL3447	46
SEL3451	47
SEL3452	47
SEL3453	47

S

SEL712006	44
SEL712008	44
SEL712010	44
SEL712012	44
SELCGO101	45
SELCP102	45
SELCP104	45
SELCP106	45
SELPXV101	45
SELRXO101	45
SELRXO102	45
SOC10SG	71
SOC15SG	71
SOC20SG	71
SOC30SG	71
SOPC10SG	71
SOPC15SG	71
SOPC20SG	71
SOPC30SG	71
ST-16	34
ST-20	34
ST-25	34
ST-32	34
ST-40	34
ST-BASE	36
STC-16	34
STC-20	34
STC-25	34
STC-32	34
STC-40	34
ST-CLIP	35

T

TPQSM32	19
---------	----

U

U12-C	15
U18-C	15
U24-C	15
U2x18-C	15
U36-C	15
U3x18-C	15
U407	3
U407 R	4
U408	3
U408 Black	24
U408 R	4
U408 White	24
U409	3
U409 Black	24
U409 R	4
U410	4
U410 R	4
U411	4
U411 R	4
U412	4
U412 R	4
U413R	4
U4-C	15
U8-C	15

V

V6H100100	53
V6H10060	53
V6H10080	53
V6H2525	53
V6H4025	53
V6H4040	53

Index Produit

V

V6H4060	53
V6H4080	53
V6H60100	53
V6H60120	53
V6H6025	53
V6H6040	53
V6H6060	53
V6H6080	53
V6H80100	53
V6H80120	53
V6H8025	53
V6H8040	53
V6H8060	53
V6H8080	53
VD16 FLH	2
VD16 LLH	2
VD16 MLH	2
VD20 FLH	2
VD20 LLH	2
VD20 LLHBLACK ..	2
VD20 MLH	2
VD20HFPPMOF	3
VD25 LH	2
VD25 LLH	2
VD25HPPPMOF ...	3
VD32 LH	2
VD32 LLH	2
VD40 LH	2
VD50 LH	2
VD63 LH	2

WWW.GSV.BE

09/2021



#GSV-WEB



#GSV

TERBEKEHOFDREEF 51
2610 WILRIJK

T: +32 3 326 50 77

F: +32 3 326 49 23

WWW.GSV.BE
E: office@gsv.be

BTW/TVA BE 0427.142.369
HRA/RCA 245.824



SINDS | DEPUIS 1985
WIJ BEVESTIGEN UW TOEKOMST
UNE ATTACHE POUR VOTRE AVENIR