

Canali portacavi e portautenze per installazione industriale di cavi, tubazioni, ecc.

Materiale: PVC Rigido Autoestinguente Classe 1 (UL94-V0).

Lunghezza: 2 metri

Colore standard Grigio tipo 7030 e bianco tipo 9010

I canali vengono forniti completi di coperchio.

A richiesta possono essere forniti coperchi adeguati alle applicazioni ove è necessaria la smontabilità con attrezzo.

Cable ducting systems for industrial installations of cables, tubing, etc.

Self-extinguishing rigid PVC Class 1 (UL94-V0).

Length: 2 meters

Standard colour Grey Type 7030 and White Type 9010

All trunkings come complete with cover.

Upon request we can supply covers that suit those applications where disassembling by tool is required.

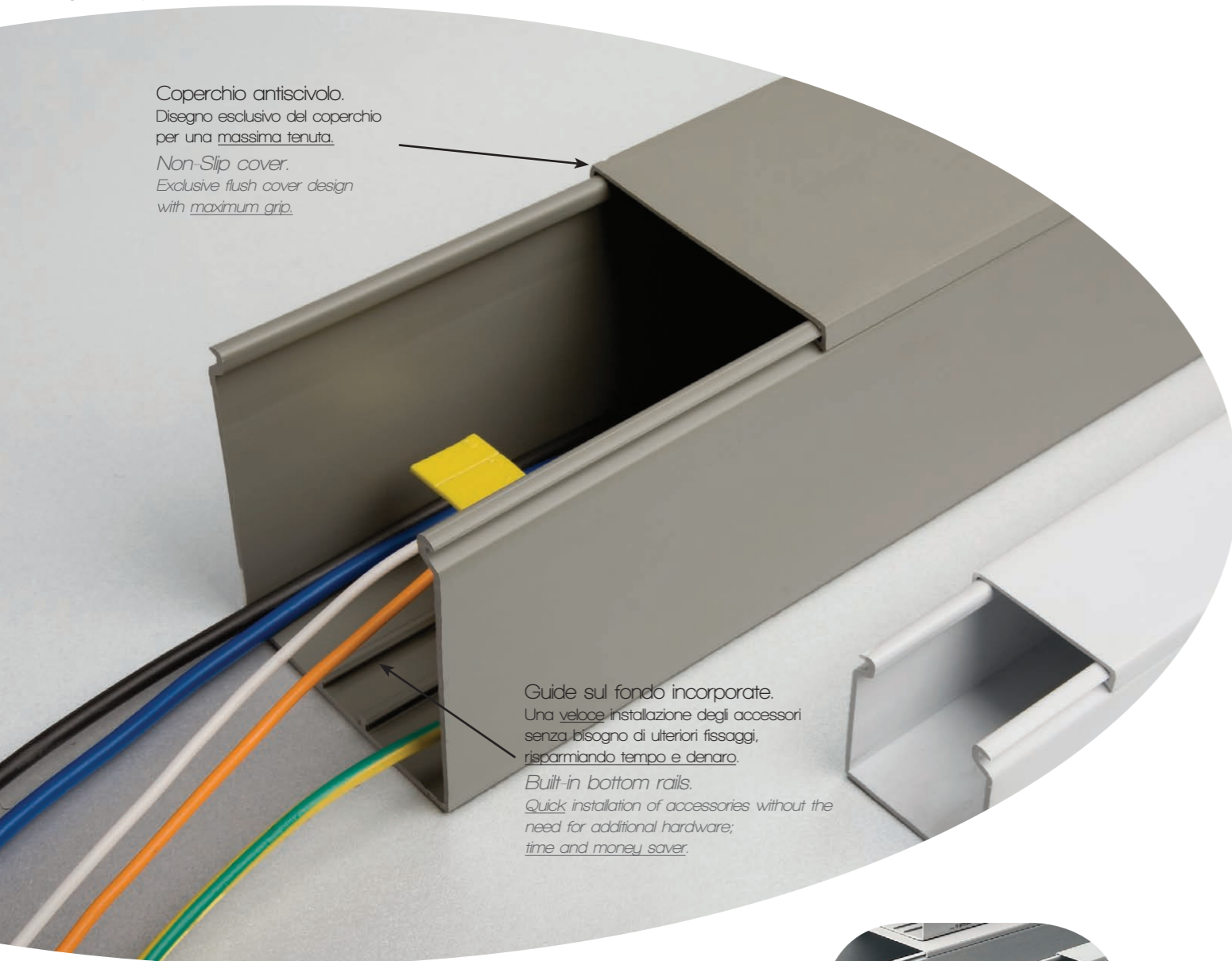

Coperchio antiscivolo.
Disegno esclusivo del coperchio per una massima tenuta.

Non-Slip cover.
Exclusive flush cover design with maximum grip.

Guide sul fondo incorporate.

Una veloce installazione degli accessori senza bisogno di ulteriori fissaggi, risparmiando tempo e denaro.

Built-in bottom rails.

Quick installation of accessories without the need for additional hardware; time and money saver.

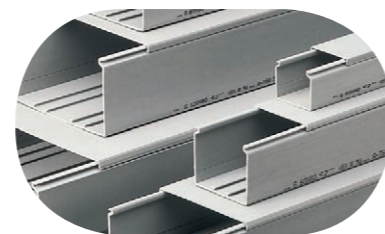

Guide Rails	Sezione fondo Section of the bottom	Codice Code	Dimensioni BxH mm Duct Size BxH mm	Imballo m Standard Carton m	S.G. mm ² G.S. mm ²	Lung. barre m Length m	Cartone peso Kg Carton Weight Kg
----------------	----------------------------------------	----------------	---------------------------------------	--------------------------------	----------------------------------------------	---------------------------	-------------------------------------

Grigio - Grey

▲		G16		25x30	80	550	2	18,4
		G23		40x30	48	920	2	15,0
		G24		60x30	32	1400	2	15,7
		G13		25x40	80	760	2	18,2
		G8		40x40	40	1310	2	18,0
▲		G4		60x40	24	1960	2	13,0
▲		G26		80x40	24	2665	2	15,8
▲		G27		100x40	16	3375	2	13,1
▲		G28		120x40	20	4070	2	20,8
▲		G5		40x60	36	1960	2	21,7
▲		G9		60x60	24	3080	2	18,0
▲		G6		80x60	24	4175	2	22,0
▲		G17		100x80	20	5295	2	21,0
▲		G10		120x80	16	6390	2	19,3
▲		G30		150x80	12	8070	2	18,8
▲		G31		200x80	8	10820	2	18,4
▲		G11		60x80	24	4200	2	22,5
▲		G12		80x80	24	5695	2	28,2
▲		G19		100x80	16	7215	2	21,2
▲		G32		120x80	16	8710	2	23,1
▲		G33		150x80	12	10770	2	21,2
▲		G48		200x80	8	14470	2	18,6
▲		G37		100x100	16	8135	2	28,0
▲		G38		120x100	8	10820	2	15,3
▲		G39		150x100	8	13670	2	17,5
▲		G40		200x100	8	18370	2	20,8
		G47		120x120	8	13120	2	18,5
		G43*		100x150	8	13695	2	17,0
▲		G50*		250x70	8	15720	2	22

Bianco - White

		G16BEU		25x30	80	550	2	18,4
		G23BEU		40x30	48	920	2	15,0
		G24BEU		60x30	32	1400	2	15,7
		G8BEU		40x40	40	1310	2	18,0
▲		G4BEU		60x40	24	1960	2	13,0
▲		G26BEU		80x40	24	2665	2	15,8
▲		G27BEU		100x40	16	3375	2	13,1
▲		G28BEU		120x40	20	4070	2	20,8
▲		G9BEU		60x60	24	3080	2	18,0
▲		G6BEU		80x60	24	4175	2	22,0
▲		G17BEU		100x80	20	5295	2	21,0
▲		G10BEU		120x80	16	6390	2	19,3
▲		G30BEU		150x80	12	8070	2	18,8
▲		G31BEU		200x80	8	10820	2	18,4
▲		G19BEU		100x80	16	7215	2	21,2
▲		G32BEU		120x80	16	8710	2	23,1
▲		G33BEU		150x80	12	10770	2	21,2
▲		G48BEU		200x80	8	14470	2	18,6
▲		G40BEU		200x100	8	18370	2	20,8
▲		G50BEU*		250x70	8	15720	2	22

▲ Canali con guide sul fondo. / Trunkings with rails on the bottom. Sezione piana Flat section

Sezione con guida Section with rail

* No IMQ

COPERCHI TIPO G TRADIZIONALI.
STANDARD TYPE G COVERS.

Codice Code	Larghezza mm Size mm	Lung. barre m Length m
GCOP25	25	2
GCOP40	40	2
GCOP60	60	2
GCOP80	80	2
GCOP100	100	2
GCOP120	120	2
GCOP150	150	2
GCOP200	200	2
GCOP25BEU	25	2
GCOP40BEU	40	2
GCOP60BEU	60	2
GCOP80BEU	80	2
GCOP100BEU	100	2
GCOP120BEU	120	2
GCOP150BEU	150	2
GCOP200BEU	200	2

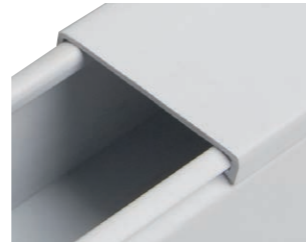

COPERCHI TIPO G SMONTABILI CON ATTREZZO.
COVERS TYPE G REMOVABLE BY TOOL.

Codice Code	Larghezza mm Size mm	Lung. barre m Length m
GCOP80SA	80	2
GCOP100SA	100	2
GCOP120SA	120	2
GCOP150SA	150	2
GCOP200SA	200	2
GCOP80SABEU	80	2
GCOP100SABEU	100	2
GCOP120SABEU	120	2
GCOP150SABEU	150	2
GCOP200SABEU	200	2

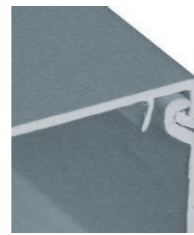

ACCESSORI DI FISSAGGIO.
FIXING ACCESSORIES.

RIV

Vite e dado.
Materiale: Nylon
Screw and nut.
Material: Nylon

COLORI / COLORS : Bianco / White

Codice Code	Ø	Imballo pz. Packing pcs
RIV6	6	1000 (10x100)
RIV8	8	500 (5x100)



TS

Tassello ad espansione.
Per il fissaggio dei canali a parete, 2-3 per metro.
Completamente isolato, con testa vite a scomparsa.
Materiale: Nylon
Wall plug.
For wall-mounting of the ducting, 2-3 for m.
Completely isolated, with a countersunk screw.
Material: Nylon

COLORI / COLORS : Nero / Black

- Grigio / Grey Type 7030 BEU - Bianco / White Type 9010

Codice Code	Ø	Imballo pz. Packing pcs
TS	6	100



GUIDE SUL FONDO E SEPARATORI.
SIZES AND LAYOUT OF RAILS FOR SEPARATORS USE.

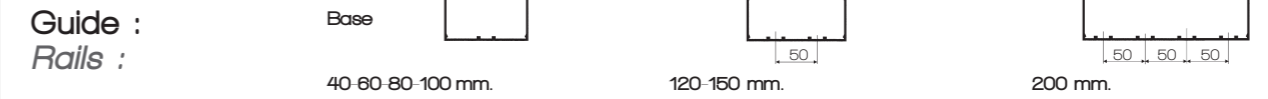

Il canale si fissa a parete con tasselli TS, 2/4 per metro per le misure piccole, 4/8 per metro per le misure più grandi.

Trunking is fastened to the wall by TS nogs, 2/4 per meter for the smaller sizes, 4/8 per meter for the larger sizes.

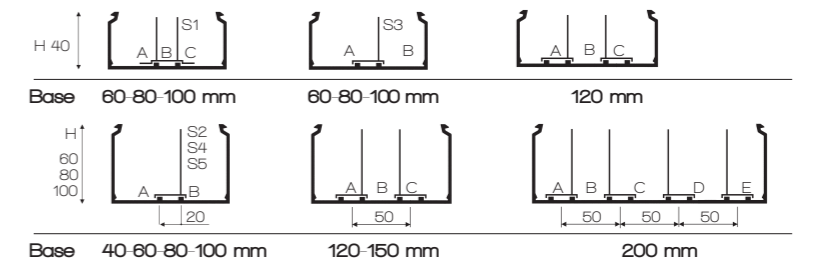

UTILIZZO DEI SEPARATORI S ALL'INTERNO DEI CANALI TIPO G.
USE OF THE S SEPARATORS INSIDE OF G TYPE TRUNKINGS.

B x H	N° scomparti / N° compartments	Sezione / Section				
		A mm ²	B mm ²	C mm ²	D mm ²	E mm ²
mm.	S1					
60 x 40	3	680	425	680	-	-
80 x 40	3	1030	425	1030	-	-
100 x 40	3	1387	425	1387	-	-
	S2 / S3 / S4 / S5					
60 x 40	2	1223	737	-	-	-
80 x 40	2	1570	1090	-	-	-
100 x 40	2	1930	1445	-	-	-
120 x 40	3	1387	1295	1387	-	-
40 x 60	2	1150	680	-	-	-
60 x 60	2	2060	1020	-	-	-
80 x 60	2	2607	1567	-	-	-
100 x 60	2	3167	2127	-	-	-
120 x 60	3	2170	2035	2170	-	-
150 x 60	3	3015	2035	3015	-	-
200 x 60	5	1750	2035	2640	2640	1750
60 x 80	2	2820	1380	-	-	-
80 x 80	2	3567	2127	-	-	-
100 x 80	2	4327	2887	-	-	-
120 x 80	3	2965	2775	2965	-	-
150 x 80	3	3995	2775	3995	-	-
200 x 80	5	2247	2775	3600	3600	2247
100 x 100	2	5487	3647	-	-	-
120 x 100	3	3705	3404	3705	-	-
150 x 100	3	5130	3404	5130	-	-
200 x 100	5	3065	3404	4416	4416	3065

S

Separatore cavi.
Per separare i cavi all'interno dei canali.
Si monta a scatto sulle guide presenti sul fondo del canale.
Opportunamente posizionato crea scomparti di sezione diversa.

Cable separator.
For separating the cables housed inside the ducting.
Snap on the built-in rail of the duct.
Several separation schemes can be obtained using different separators.

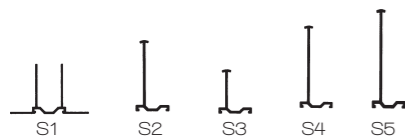

Codice Code	H mm H mm
S1 (2 separatori) (2 separators)	40
S2	60
S3	40
S4	80
S5	100

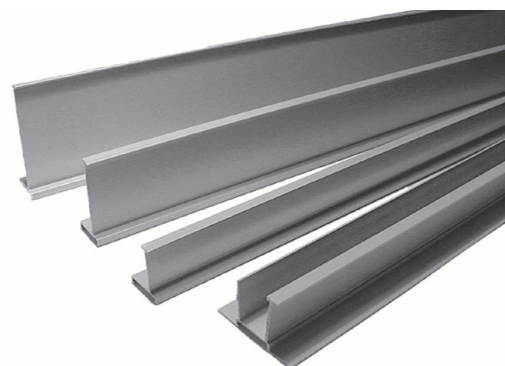

Dati tecnici
Technical data

PG

Piatto per giunzione fondo canali.
Trunkings connection plate.
75x200 mm

Si fissa con viti e dadi RIV6.
Fix with screws and nuts RIV6.

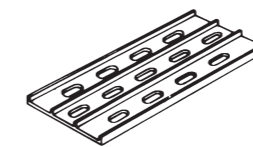
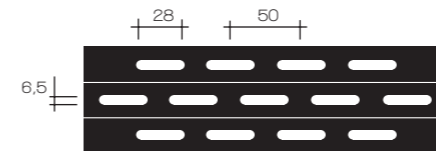

Dati tecnici
Technical data

FCV

Traversino contenimento cavi.
Si monta a scatto negli appositi ganci sulla base interna del canale. Fratturare le alette in funzione della larghezza del canale.

Cable retaining Cross arm.
It can be snapped on into the proper hooks located in the inner base of the duct. Break the fins according to the width of the duct.

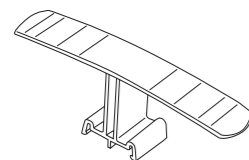

Codice Code	Per canali For trunkings
FCV12040	60/120x40
FCV12060	40/200x60

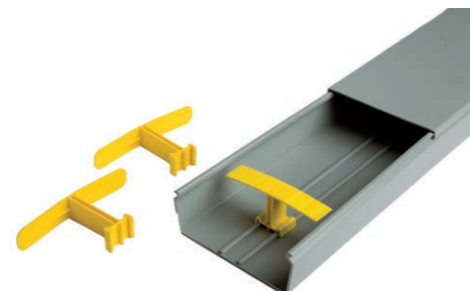

LDG

Giunto canali e snodo.
Misure esterne dalla base del canale per forare e fissare LDG. Forare le pareti del canale con punta Ø 8. Per formare lo snodo, spezzare a metà il giunto.

Trunkings joint and articulated coupling.
External dimensions from the base of the trunking for drilling and fixing LDG. Drill with a 8 mm dia bit. To have the articulation, cut the joint in the middle.

Codice Code	BxH mm BxH mm	Per canali H For duct H
LDG50	32x200	40
LDG60	47x180	60
LDG75	58x175	75-80
LDG100	90x175	100-120

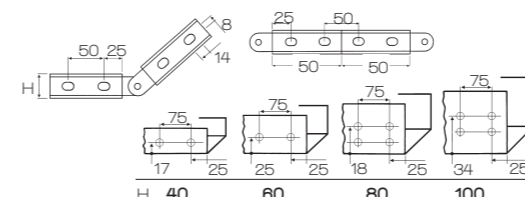

PCT

Traversino tenuta cavi.
Utilizzo del traversino tenuta cavi PCT. Si usa con separatore. Per uno o più scomparti. Si infila negli appositi ganci esistenti sui separatori.

Crossbar
Use of the crossbar PCT. For one or more compartments. To pass through the clamps provided on the separators.

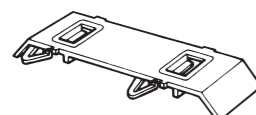

Per canali con base :
For trunkings with base:

Codice Code	Base mm Base mm
PCT050	60
PCT075	80
PCT075	100
PCT100	120
PCT125	150
PCT125	200

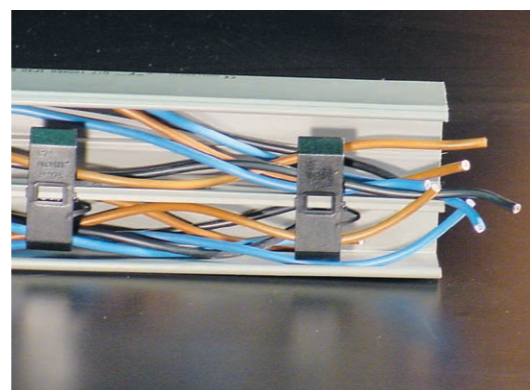

FMC

Fermacavo universale per canali H.60/80.
Applicato sulle guide dei canali impedisce lo spostamento accidentale dei cavi. Può contenere 3 cavi (massimo 5mm di diametro) per ogni foro.

Universal cable-holder. For wire ducts H. 60/80.
Application on the built-in rail of the duct to avoid accidental pulling of the wires. It can contain 3 wires (of maximum 5mm of diameter) for each hole.

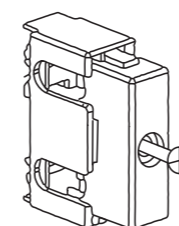

COLORI / COLORS : ■ Nero / Black

DM071

Mostrina cieca per presa telefonica e accessorio DM082.
Closed plate for lt. phone socket and DM082 accessory.
120x85 mm

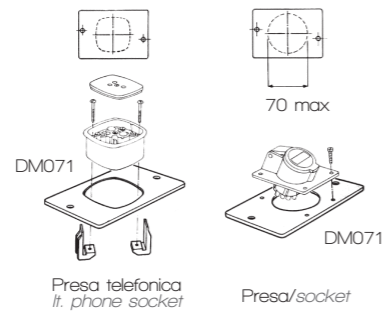
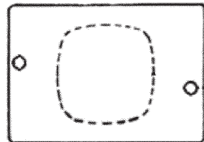

DM0736

Mostrina per il montaggio di apparecchiatura con interasse 55 e 60 mm.
Plate for fitting equipments with interaxis 55 and 60 mm.
120x85 mm

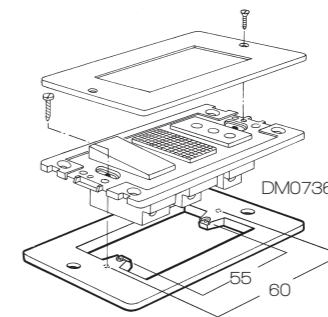
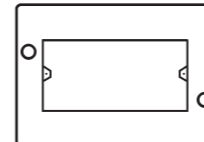

DM072

Mostrina per 4 moduli Gewiss - Ave - Ticino Int. - Ticino TT - Vimar Plana o 2 prese Schuko.
Plate for 4 Gewiss - Ave - Ticino Int. - Ticino TT Vimar Plana modules or 2 Schuko socket.
120x85 mm

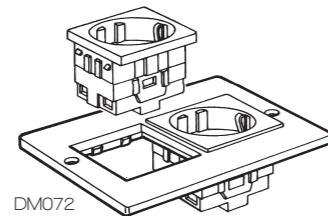
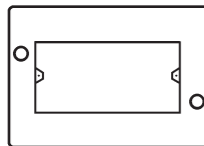

DM075

Mostrina per il montaggio in orizzontale di max 5 apparecchiature modulari (17,5) su guida DIN 48277/3. (Solo con DM105) completa di : coperchio trasparente, profilato omega, distanziale, 3 viti met. di fissaggio.
Plate for horizontal installation of max 5 modular equipment units (17,5) on DIN 48277/3 guide. (Only with DM105) complete with: transparent cover, omega profile, spacer, 3 metal fixing screws.
120x85 mm

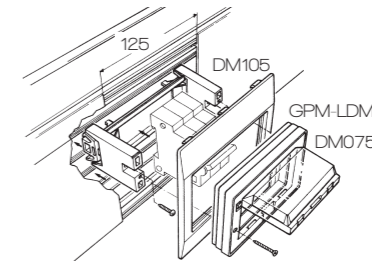
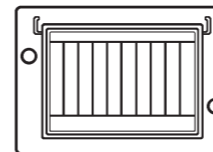

DM073

Mostrina per apparecchiature con interasse 83,5 mm.
Plate for sockets with interaxis 83,5 mm.
120x85 mm

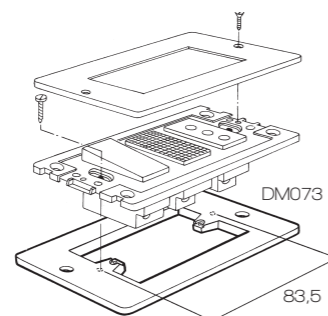
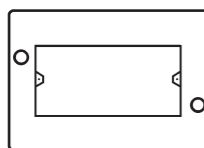

DM082

Adattatore per connettori EDP. completo di:
placchetta per connettori D-SUB (a vaso) 9/15/25 contatti, placca. per connettori DIN, placchetta senza fori per connettori.
Si utilizza anche con porta mostrine LDM205 e GPM20.
IT sockets adaptor. Includes:
plate for D-SUB computer links (bow) 9/15/25 contacts, plate for two DIN computer links, plate without holes for computer links.
Use with front plate holder LDM205 and GPM20 too.
120x85 mm

- DM0821 Per connettori D SUB (a vaschetta), 9-15-25 contatti
For D-SUB computer links (bow), 9-15-25 pins.
- DM0822 Per 2 connettori DIN
For 2 DIN computer links
- DM0823 Senza fori
Without holes

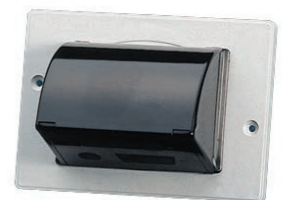
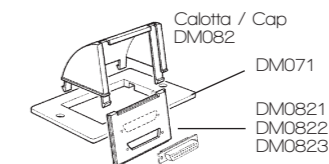

GPM per canali Tipo G / for Type G trunkings.

Placche porta mostrine per canali Tipo G.

Per il montaggio delle mostrine DM071, DM072, DM073, DM075 (con distanziatore).
 Si incastrano a scatto sul canale.

Front plate panel point for Type G trunkings.

For mounting of DM071, DM072, DM073, DM075 (with spacer).
 Click on the trunking.

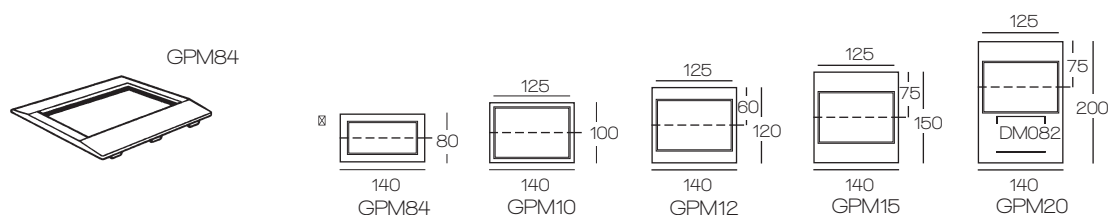

⊠ Non usa mostrine / It does not use plates.