

# EASYCONNECT<sup>®</sup>

## BASKET TRAY

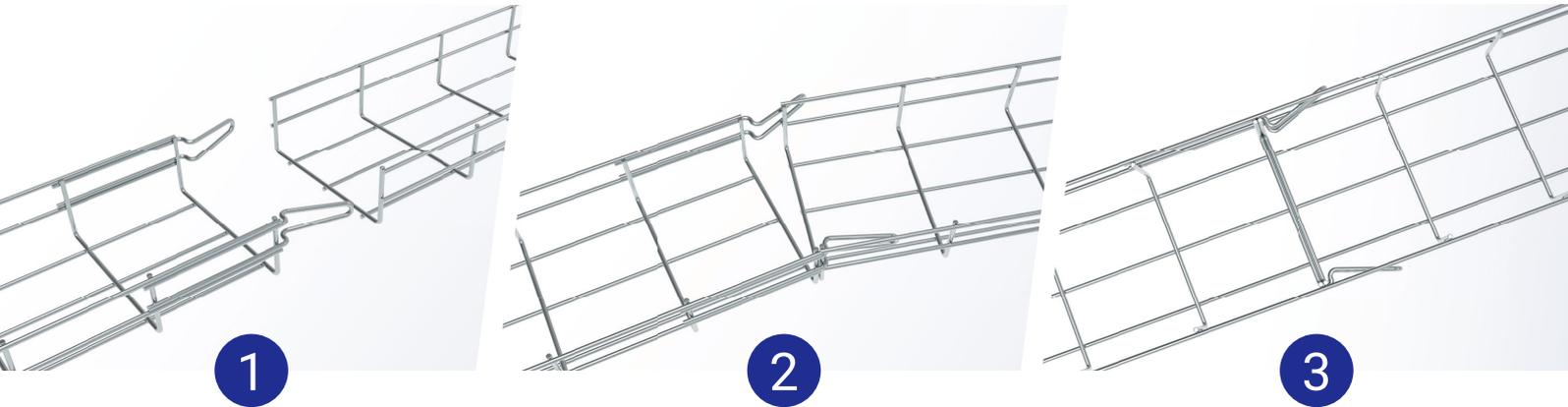

## RESISTANCE & SECURITY IN 1 CLICK

- Patented self-joining system
- Reduces costs and installation time
- Increase safety and life span

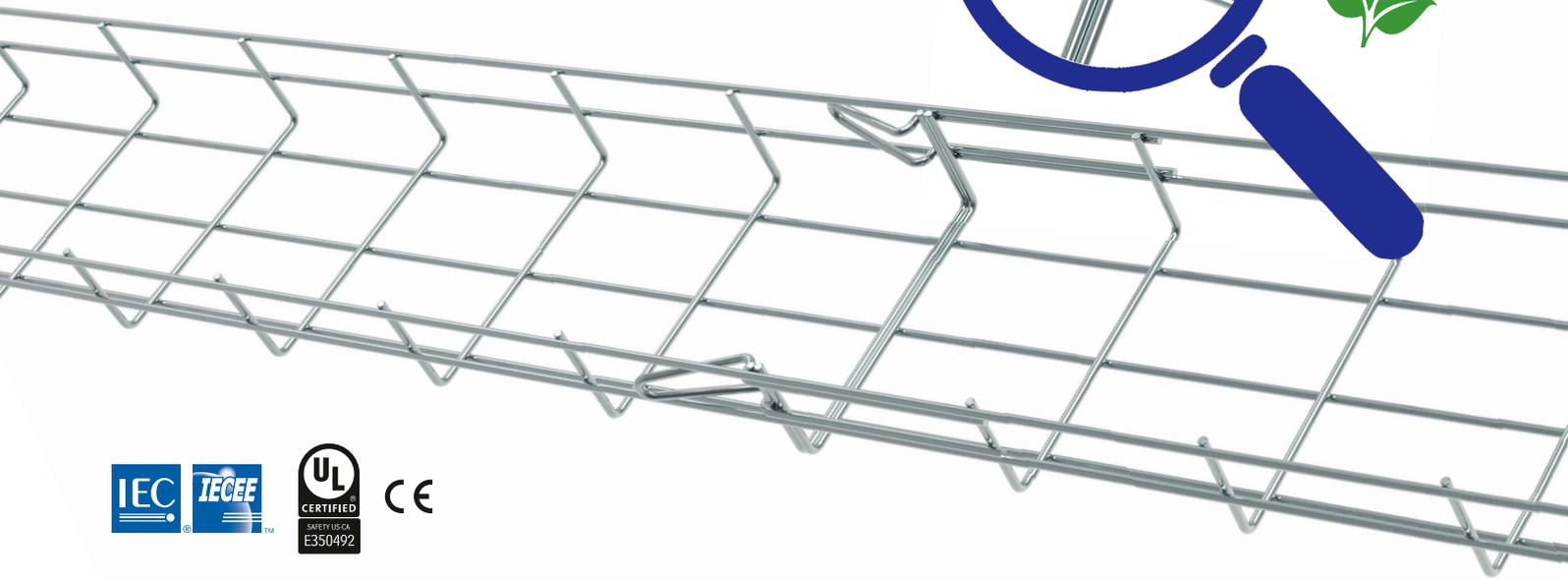

**Validinox**  
THE CABLE TRAY COMPANY



FACTORY: Villanueva, 12 - San Mamés de Meruelo (39192) Cantabria, España  
WAREHOUSE: Bº El Campo S/N - Meruelo (39192) Cantabria, España  
Tel: (+34) 942 677 135 - (+34) 942 674 992  
Fax: (+34) 942 637 901 - (+34) 942 677 020  
Email: [validinox@validinox.com](mailto:validinox@validinox.com) - [export@validinox.com](mailto:export@validinox.com)  
[www.validinox.com](http://www.validinox.com)

		 	H (mm)	W (mm)	Su* (cm <sup>2</sup> )	SWL (N/m)
EC30.060EZ	EC30.060HDG	EC30.060IN	35	70	16,92	172
EC30.100EZ	EC30.100HDG	EC30.100IN	35	102	26,87	178
EC30.150EZ	EC30.150HDG	EC30.150IN	35	152	42,42	188
EC30.200EZ	EC30.200HDG	EC30.200IN	35	202	57,97	199
EC30.300EZ	EC30.300HDG	EC30.300IN	35	302	87,43	221

Length: 3 m

\* Sección transversal / Cross Section / Section transversale

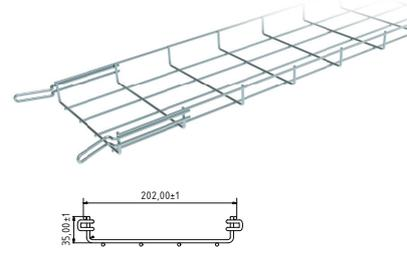

		 	H (mm)	W (mm)	Su* (cm <sup>2</sup> )	SWL (N/m)
EC60.060EZ	EC60.060HDG	EC60.060IN	55	60	22,69	290
EC60.060EZ-6W	EC60.060HDG-6W	EC60.060IN-6W**	51	66	23,74	290
EC60.100EZ	EC60.100HDG	EC60.100IN	60	102	48,47	323
EC60.150EZ	EC60.150HDG	EC60.150IN	60	152	76,52	345
EC60.200EZ	EC60.200HDG	EC60.200IN	60	202	104,57	368
EC60.300EZ	EC60.300HDG	EC60.300IN	60	302	158,63	413
EC60.400EZ	EC60.400HDG	EC60.400IN	60	402	211,86	457
EC60.500EZ	EC60.500HDG	EC60.500IN	60	502	266,73	502
EC60.600EZ	EC60.600HDG	EC60.600IN	60	602	321,93	547

Length: 3 m

\* Sección transversal / Cross Section / Section transversale

\*\* H=55 mm; W=73 mm; Su=29,4 cm<sup>2</sup>

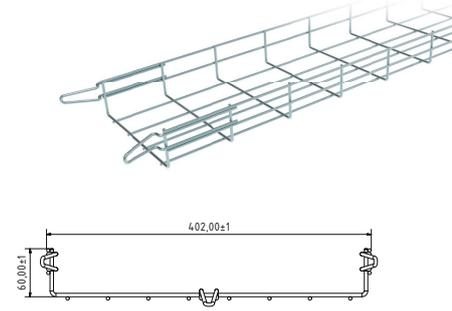

		 	H (mm)	W (mm)	Su* (cm <sup>2</sup> )	SWL (N/m)
EC100.150EZ	EC100.150HDG	EC100.150IN	108	152	139,79	441
EC100.200EZ	EC100.200HDG	EC100.200IN	108	202	191,64	462
EC100.300EZ	EC100.300HDG	EC100.300IN	108	302	292,88	504
EC100.400EZ	EC100.400HDG	EC100.400IN	108	402	395,46	546
EC100.500EZ	EC100.500HDG	EC100.500IN	108	502	498,66	588
EC100.600EZ	EC100.600HDG	EC100.600IN	108	602	601,86	630

Length: 3 m

\* Sección transversal / Cross Section / Section transversale

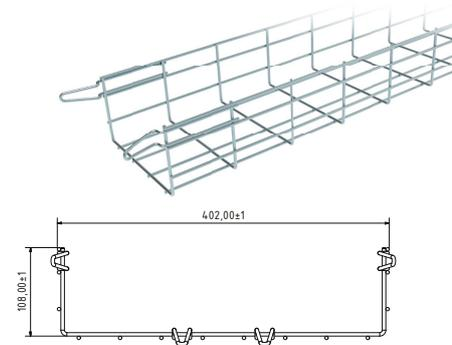

		 	H (mm)	W (mm)	Su* (cm <sup>2</sup> )	SWL (N/m)
EC150.200EZ	EC150.200HDG	EC150.200IN	155	208	285,08	599
EC150.300EZ	EC150.300HDG	EC150.300IN	158	308	443,05	606
EC150.400EZ	EC150.400HDG	EC150.400IN	158	408	596,25	615
EC150.450EZ	EC150.450HDG	EC150.450IN	155	458	659,68	623
EC150.500EZ	EC150.500HDG	EC150.500IN	158	508	749,45	631
EC150.600EZ	EC150.600HDG	EC150.600IN	158	608	902,04	638

Length: 3 m

\* Sección transversal / Cross Section / Section transversale

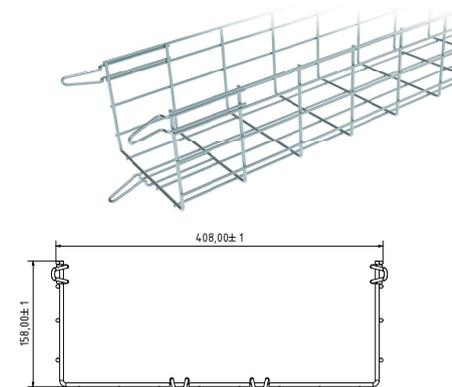

TYPE OF ACCESSORY

ZF Fixing

SG Supporting

IN<sub>304</sub> Installation

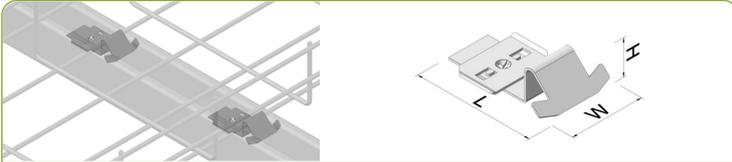

**ZF**

	H (mm)	W (mm)	L (mm)
CFR41ZF	16	34	53



**ZF** **IN<sub>304</sub>**

	H (mm)	W (mm)	L (mm)
CPUZF CPUIN	8	18	30



**EZ** **ZF** **IN<sub>304</sub>**

	W (mm)	L (mm)
FASEZ FASZF FASIN	23	20



**SG** **EZ** **HDG** **IN<sub>304</sub>**

	L (mm)	W (mm)
JS200SG JS200EZ JS200HDG JS200IN	200	22
JS400SG JS400EZ JS400HDG JS400IN	400	22
JS750SG JS750EZ JS750HDG JS750IN	750	22
JS1050SG JS1050EZ JS1050HDG JS1050IN	1050	22

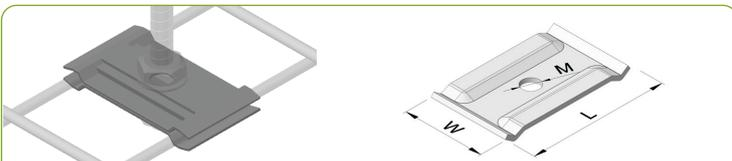

**EZ** **ZF** **IN<sub>304</sub>**

	W (mm)	L (mm)	M Ø
SC6EZ SC6ZF SC6IN	35	60	6
SC8EZ SC8ZF SC8IN	35	60	8
SC10EZ SC10ZF SC10IN	35	60	10



**EZ** **ZF** **IN<sub>304</sub>**

	W (mm)	L (mm)
UUEZ UUZF UUIN	25	24



**SG** **IN<sub>304</sub>**

	H (mm)	L1 (mm)	L2 (mm)
OHC060SG OHC060IN	125	83	53
OHC100SG OHC100IN	125	104	53
OHC150SG OHC150IN	125	154	53

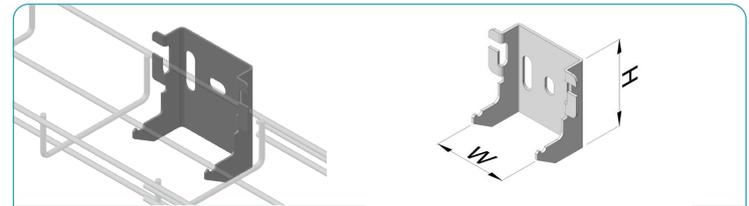

**SG** **ZF** **IN<sub>304</sub>**

	H (mmv)	W (mm)
PS30SG PS30ZF PS30IN	75	64

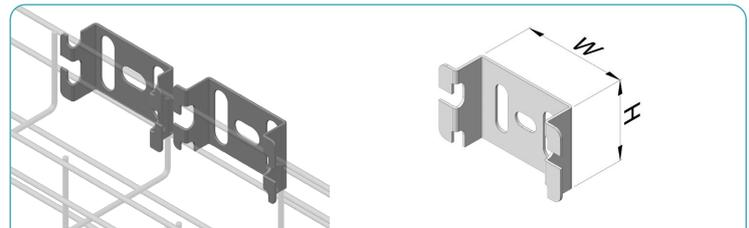

**SG** **ZF** **IN<sub>304</sub>**

	H (mm)	W (mm)
PS60SG PS60ZF PS60IN	50	65

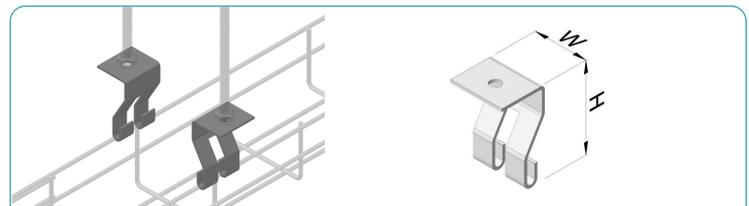

**SG** **ZF** **IN<sub>304</sub>**

	W (mm)	L (mm)
PSTSG PSTZF PSTIN	65	40

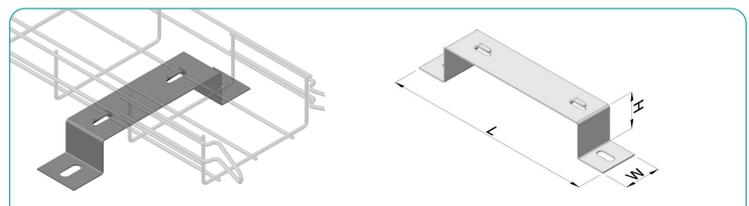

**SG** **HDG** **IN<sub>304</sub>**

	H (mm)	W (mm)	L (mm)
SD60SG SD60HDG SD60IN	50	60	164
SD100SG SD100HDG SD100IN	50	50	190
SD150SG SD150HDG SD150IN	50	50	240
SD200SG SD200HDG SD200IN	50	50	290
SD300SG SD300HDG SD300IN	50	50	390
SD400SG SD400HDG SD400IN	50	50	490
SD500SG SD500HDG SD500IN	50	50	590
SD600SG SD600HDG SD600IN	50	50	690

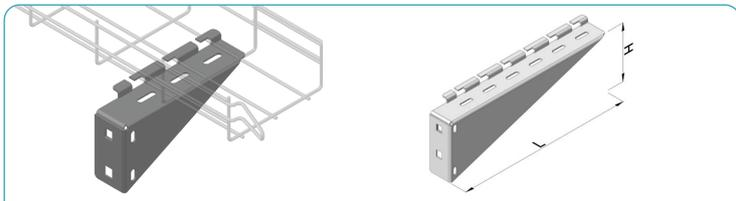

<b>SG</b>	<b>HDG</b>	<b>IN 304</b>	<b>H (mm)</b>	<b>L (mm)</b>
SE100SG	SE100HDG	SE100IN	86	141
SE150SG	SE150HDG	SE150IN	86	190
SE200SG	SE200HDG	SE200IN	86	241
SE300SG	SE300HDG	SE300IN	111	341
SE400SG	SE400HDG	SE400IN	121	441
SE500SG	SE500HDG	SE500IN	162	541
SE600SG	SE600HDG	SE600IN	159	641

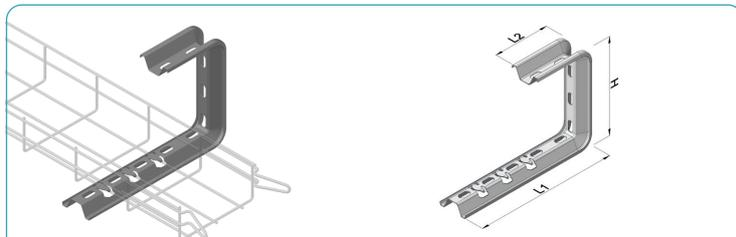

<b>SG</b>	<b>HDG</b>	<b>IN 304</b>	<b>H (mm)</b>	<b>L1 (mm)</b>	<b>L2 (mm)</b>
SOPC10SG	SOPC10HDG	SOPC10IN	180	215	115
SOPC15SG	SOPC15HDG	SOPC15IN	180	265	115
SOPC20SG	SOPC20HDG	SOPC20IN	180	315	115
SOPC30SG	SOPC30HDG	SOPC30IN	180	415	115



<b>SG</b>	<b>ZF</b>	<b>IN 304</b>	<b>W (mm)</b>	<b>L (mm)</b>
SESE	SEZF	SEIN	30	110

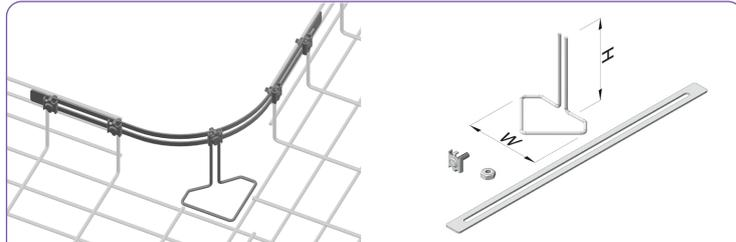

<b>EZ</b>	<b>IN 304</b>	<b>H (mm)</b>	<b>W (mm)</b>	<b>L (mm)</b>
Wire Base 100EZ	Wire Base 100IN	105	100	—
Wire Base 150EZ	Wire Base 150IN	150	100	—
JS500EZ	JS500IN	22	—	500
FASEZ	FASIN	—	23	20

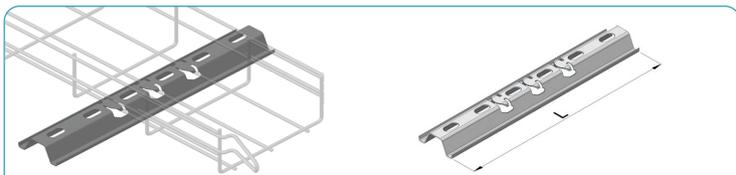

<b>SG</b>	<b>HDG</b>	<b>IN 304</b>	<b>L (mm)</b>
SOA10SG	SOA10HDG	SOA10IN	250
SOA15SG	SOA15HDG	SOA15IN	300
SOA20SG	SOA20HDG	SOA20IN	350
SOA30SG	SOA30HDG	SOA30IN	450
SOA40SG	SOA40HDG	SOA40IN	550
SOA50SG	SOA50HDG	SOA50IN	650
SOA60SG	SOA60HDG	SOA60IN	750

<b>EZ</b>	<b>IN 304</b>	<b>FASEZ</b>	<b>JS500EZ</b>	<b>Wire Base</b>
CFK100EZ	CFK100IN	5	1	1
CFK150EZ	CFK150IN	10	2	1

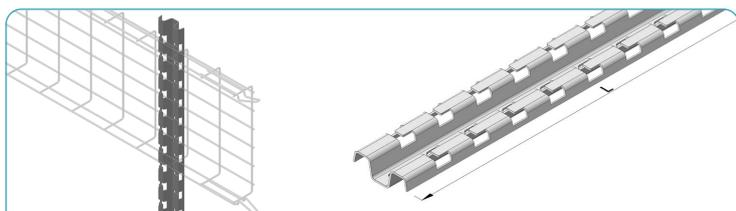

<b>SG</b>	<b>HDG</b>	<b>IN 304</b>	<b>L (mm)</b>
SOAL1SG	SOAL1HDG	SOAL1IN	1000
SOAL2SG	SOAL2HDG	SOAL2IN	2000
SOAL3SG	SOAL3HDG	SOAL3IN	2990

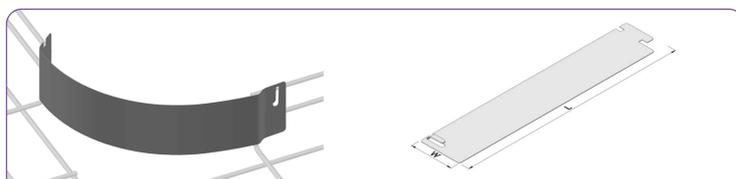

<b>SG</b>	<b>IN 304</b>	<b>W (mm)</b>	<b>L (mm)</b>
CPBSG	CPBIN	55	290
CPB100SG	CPB100IN	103	290

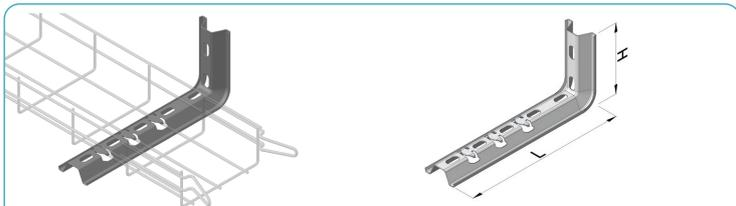

<b>SG</b>	<b>HDG</b>	<b>IN 304</b>	<b>H (mm)</b>	<b>L (mm)</b>
SOC10SG	SOC10HDG	SOC10IN	115	215
SOC15SG	SOC15HDG	SOC15IN	115	265
SOC20SG	SOC20HDG	SOC20IN	115	315
SOC30SG	SOC30HDG	SOC30IN	115	415
SOC40SG	SOC40HDG	SOC40IN	115	515



<b>SG</b>	<b>ZF</b>	<b>IN 304</b>	<b>H (mm)</b>	<b>W (mm)</b>
DB30SG	DB30ZF	DB30IN	70	90



<b>SG</b>	<b>ZF</b>	<b>IN 304</b>	<b>H (mm)</b>	<b>W (mm)</b>
DB100SG	DB100ZF	DB100IN	95	66

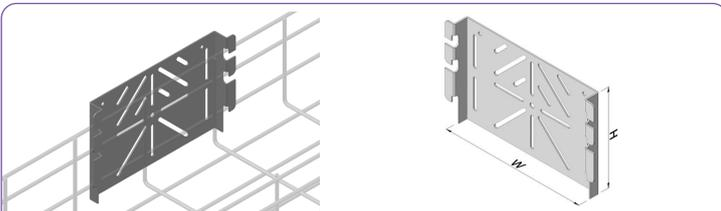

SG ZF IN<sub>304</sub>  
 DB100XLSG DB100XLZF DB100XLIN

H (mm)	W (mm)
120	180

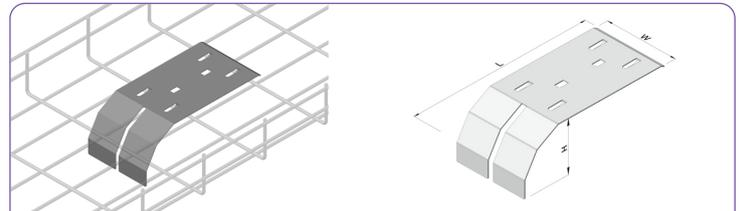

SG IN<sub>304</sub>  
 SCLMSG SCLMIN

H (mm)	W (mm)	L (mm)
68	91	189

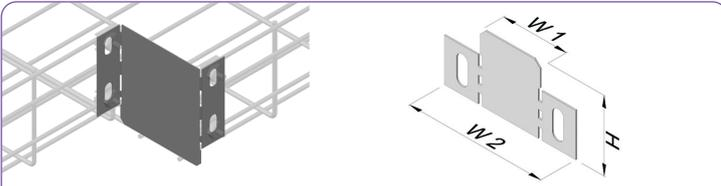

SG ZF IN<sub>304</sub>

H (mm)	W1 (mm)	W2 (mm)
57,15	50,8	111,13
107,95	50,8	111,13
57,15	101,6	161,93
107,95	101,6	161,93

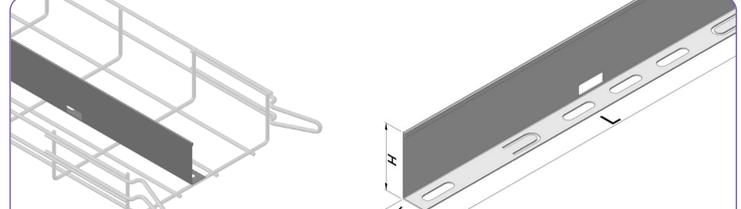

SG HDG IN<sub>304</sub>

H (mm)	W (mm)	L (mm)
29	19	3000
50	19	3000
90	19	3000

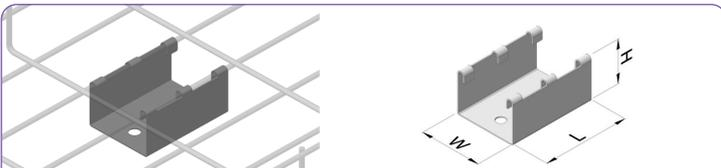

SG ZF IN<sub>304</sub>  
 LFSSG LFSZF LFSIN

H (mm)	W (mm)	L (mm)
40	57	80



SG ZF IN<sub>304</sub>  
 CSEPSG CSEPZF CSEPIN

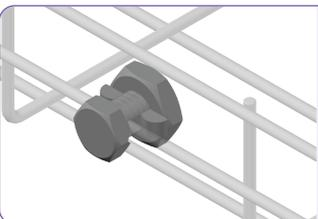

**Ref.**  
MAT Brass

Diametre of earthing cable: 25mm  
 Available for larger cable diameters

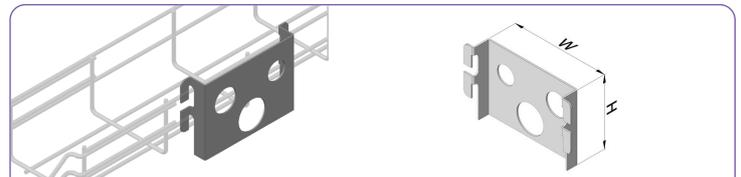

SG ZF IN<sub>304</sub>  
 STSG STZF STIN

H (mm)	W (mm)
80	110

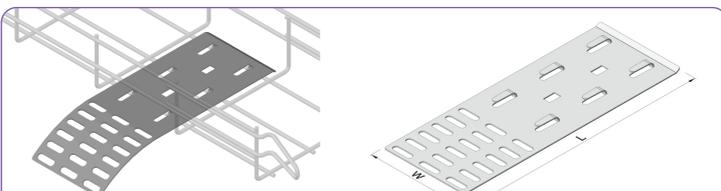

SG EZ ZF IN<sub>304</sub>  
 SCSG SCEZ SCZF SCIN

W (mm)	L (mm)
87	230

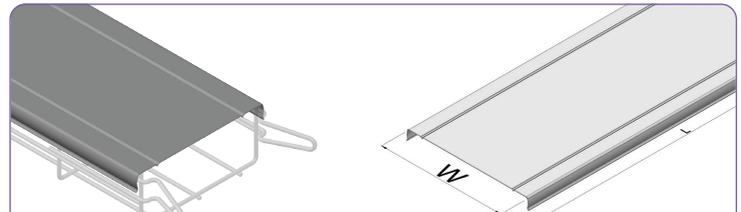

SG IN<sub>304</sub>

W (mm)	L (mm)
65	2000
102	2000
152	2000
202	2000
302	2000
402	2000
502	2000
602	2000

\* Also available in HDG under request

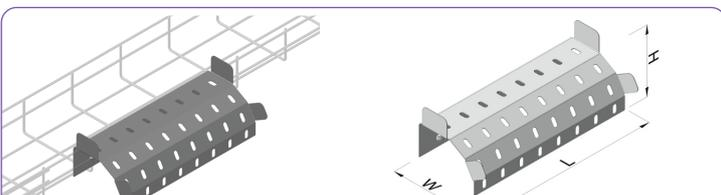

SG IN<sub>304</sub>  
 SCASG SCAIN

H (mm)	W (mm)	L (mm)
68	102	275



**Ref.**  
PLASTIC TAG

# valdinox

THE CABLE TRAY COMPANY

VALDINOX, is the spanish pioneer on the manufacturing of wire mesh cable trays, being among the most experienced manufacturers in Europe.

Our innovative wire mesh cable trays are the result of a wide knowledge accrued for more than 30 years and our commitment to technical quality and customer service.

**EASYCONNECT**<sup>®</sup>

BASKET TRAY

