

 HALOGEN FREE  FIRE RESISTANT

BEVESTIGINGSMATERIAAL MATERIEL DE FIXATION

CATALOGUS
CATALOGUE

2023
02

G2V 

SINDS | DEPUIS 1985

WIJ BEVESTIGEN UW TOEKOMST
UNE ATTACHE POUR VOTRE Avenir

PVC BUIZEN EN TOEBEHOREN TUBES PVC ET ACCESSOIRES

Buizen HALOGEN FREE- PC

Tubes HALOGEN FREE - PC



BESTELNUMMER N° DE COMMANDE	∅	LENGTE LONGUEUR	
VD16 LLH	16 mm	3m	111/5550 m
VD20 LLH	20 mm	3m	111/5550 m
VD20 LLHBLACK	20 mm*	3m	111/5550 m
VD25 LLH	25 mm	3m	57/5130 m
VD25 LLHBLACK	25 mm	3m	57/5130 m
VD32 LLH	32 mm	3m	57 /4275 m

Light Load (2442) : LLH

Lengte / Longueur: 3m

RAL 7035 / *Black RAL 9004

PC = polycarbonaat/polycarbonate



Buizen HALOGEN FREE - PC

Tubes HALOGEN FREE - PC



BESTELNUMMER N° DE COMMANDE	∅	
VD16 MLH	16 mm	111/5550 m
VD20 MLH	20 mm	111/5550 m

Medium Load (3442) : MLH - PC = polycarbonaat/polycarbonate

Lengte / Longueur: 3m - RAL 7035



Buizen HALOGEN FREE - PC

Tubes HALOGEN FREE - PC



BESTELNUMMER N° DE COMMANDE	∅	
VD16 FLH	16 mm	111/5550 m
VD20 FLH	20 mm	111/5550 m
VD25 LH	25 mm	57/5130 m
VD32 LH	32 mm	57/4275 m
VD40 LH	40 mm	30 m
VD50 LH	50 mm	15 m

Heavy Load (4442) : FLH/LH

Lengte / Longueur: 3m

RAL 7035

PC = polycarbonaat/polycarbonate



PVC BUIZEN EN TOEBEHOREN TUBES PVC ET ACCESSOIRES

Buizen HALOGEN FREE - PC

Tubes HALOGEN FREE - PC



BESTELNUMMER N° DE COMMANDE	∅	
VD63 LH	63 mm	3 m

Heavy Load (4442) : FLH/LH

Lengte / Longueur: 3m

RAL 7035

PC = polycarbonaat/polycarbonate



Buizen HALOGEN FREE PP met manchet

Tubes HALOGEN FREE PP avec manchon



BESTELNUMMER N° DE COMMANDE	∅	
VD20HFPPMOF	20 mm	102/5100 m
VD25HFPPMOF	25 mm	75/3750 m

Light Grey = RAL 7035

PP= polypropylène/polypropyleen



Buis halfzacht, met trekdraad

Tube semi rigide, avec tire-fil



BESTELNUMMER N° DE COMMANDE	∅	
ERFE20G	20 mm	100 m
ERFE25G	25 mm	50 m



Ribbenbuis

Flex



BESTELNUMMER N° DE COMMANDE	∅	
ECICTA20HFT	20 mm	100 m
ECICTA25HFT	25 mm	50 m
ECICTA20HF	20 mm*	100 m
ECICTA25HF	25 mm*	50 m

* ECICTA20HFT en / et 25HFT : Met trekdraad / Avec tire-fil



PVC BUIZEN EN TOEBEHOREN TUBES PVC ET ACCESSOIRES

Moffen voor rechte PVC buis

Manchons pour conduite rigide en PVC



BESTELNUMMER N° DE COMMANDE	∅	RAL	
U407	16 mm	RAL 7035	100/2500
U408	20 mm	RAL 7035	100/1600
U409	25 mm	RAL 7035	25/1150
U410	32 mm	RAL 7035	25/600
U411	40 mm	RAL 7035	25
U412	50 mm	RAL 7035	5
U407 R	16 mm	RAL 7037	100/2500
U408 R	20 mm	RAL 7037	100/1600
U409 R	25 mm	RAL 7037	25/1150
U410 R	32 mm	RAL 7037	25/600
U411 R	40 mm	RAL 7037	25
U412 R	50 mm	RAL 7037	5
U413R	63 mm	RAL 7037	5

Light Grey = RAL 7035

R = Dark Grey = RAL 7037



Bochten 90° voor rechte PVC buis

Coudes 90° pour conduite rigide en PVC



BESTELNUMMER N° DE COMMANDE	∅	RAL	
C16VD	16 mm	RAL 7035	50/2000
C20VD	20 mm	RAL 7035	50/1000
C25VD	25 mm	RAL 7035	20/500
C32VD	32 mm	RAL 7035	5
C40VD	40 mm	RAL 7035	5
C50VD	50 mm	RAL 7035	3
C16VD R	16 mm	RAL 7037	50/2000
C20VD R	20 mm	RAL 7037	50/1000
C25VD R	25 mm	RAL 7037	20/500
C32VD R	32 mm	RAL 7037	5
C40VD R	40 mm	RAL 7037	5
C50VD R	50 mm	RAL 7037	3
C25VDLHBLACK	25 mm	RAL 9005	5

Light Grey = RAL 7035

R = Dark Grey = RAL 7037



PVC BUIZEN EN TOEBEHOREN TUBES PVC ET ACCESSOIRES

Eindtullen voor rechte PVC buis

Embouts pour conduite rigide en PVC



BESTELNUMMER N° DE COMMANDE	∅	RAL	
EC16	16 mm	RAL 7035	100/7000
EC20	20 mm	RAL 7035	100/5500
EC25	25 mm	RAL 7035	50/2500
EC16 R	16 mm	RAL 7037	100/7000
EC20 R	20 mm	RAL 7037	100/5500
EC25 R	25 mm	RAL 7037	50/2500

Light Grey = RAL 7035

R = Dark Grey = RAL 7037



Invoertule M20

Entrées tube M20



BESTELNUMMER N° DE COMMANDE	∅	
MIBR1620	16 & 20 mm	50/2000

Light Grey = RAL 7035



PVC - LSOH PVC - LSOH

Kabeldozen met uitbrekbare ingangen voor wartels

Boîtes de dérivation avec entrées pré-imprimées



BESTELNUMMER N° DE COMMANDE	Ingangen Entrées	∅	Afm. Dim.	
220A	7	PG 16	80x80x50	10
220AM	7	20 mm	80x80x50	10

220A : Pg-maten / Mesures Pg

220AM : Metrische maten / Mesures métriques

IP 54 Druksluiting / Serrage à pression



Kabeldozen met uitbrekbare ingangen

Boîtes de dérivation avec entrées pré-imprimées



BESTELNUMMER N° DE COMMANDE	Ingangen Entrées	∅	Afm. Dim.	
222A	6	PG 16	100x100x55	5
223A	10	PG 16	175x110x66	2
223ATA	10	PG 16	175x110x83	2
224A	10	PG 29	220x170x120	1
222AM	6	20 mm	100x100x55	5
223AM	10	20 mm	175x110x66	2
223ATAM	10	20 mm	175x110x83	2
224AM	10	25 mm	220x170x120	1

222A à 224A : Pg-maten / Mesures Pg

222AM à 224AM : Metrische maten / Mesures métriques

Schroefsluiting / Serrage à vis 3/4"

IP 65



BOX LINE Kabeldoos met metrische schroefingangen

BOX LINE Boîte de dérivation avec filetage métrique



BESTELNUMMER N° DE COMMANDE	Ingangen Entrées	∅	Afm. Dim.	
J100S	7	M20	102²x56 mm	90
J100SC	7	M20	102²x56 mm	90

inclusief connector 3-fasen+n+t

inclus barrette 3-phases+n+t

IP 66



PVC - LSOH PVC - LSOH

BOX LINE Kabeldozen met nippel

BOX LINE Boîtes de dérivation avec entrées étanches



BESTELNUMMER N° DE COMMANDE	Ingangen Entrées	∅	Afm. Dim.	
J80B	8	M25	83²x50mm	1
J100B	8	M25	102²x56mm	1
J160B	8	M25	116²x70mm	1
J200B	8	M32	216x166x90n	1

IP 66



BOX LINE Kabeldozen gesloten

BOX LINE Boîtes de dérivation fermées



BESTELNUMMER N° DE COMMANDE	Ingangen Entrées	∅	Afm. Dim.	
J80L	8	M25	83 x 83 x 50 mm	1
J100L	8	M25	102 x 102 x 56mm	1
J160L	8	M25	166 x 116 x 70 mm	1
J200L	8	M32	216x166x90n	1

IP 66



Kabeldozen met nippels

Boîtes de dérivation avec entrées étanches



BESTELNUMMER N° DE COMMANDE	Ingangen Entrées	∅	Afm. Dim.	
219B	4*	PG21	45 x 80 mm	8
220B	7*	20mm	80 x 80 x 50 mm	10
222B	6**	Pg21	100 x 100 x 55 mm	5
223B	10**	Pg21	175 x 110 x 66 mm	2
223BTA	10**	Pg21	175 x 110 x 83 mm	2
224B	10**	Pg29	220 x 170 x 120 mm	1
226B	10**	Pg29	220 x 170 x 120 mm	1

*Druksluiting / Serrage à pression

**Schroefsluiting 3/4" / Serrage à vis 3/4"

IP 54



PVC - LSOH PVC - LSOH

Nippels

Embouts à gradin



BESTELNUMMER N° DE COMMANDE	Afm. Dim.	
MIB16	3,5-20 mm	50
MIB21	3,5-23,5 mm	50
MIB29	3,5-32 mm	50



Groot formaat Grands formats

Kabeldozen gesloten

Boîtes de dérivation fermées



BESTELNUMMER N° DE COMMANDE	Afm. Dim.	
242MF	330x280x175	1



Kabeldozen volledig gesloten met transparant deksel

Boîtes de dérivation fermées avec couvercle transparent



BESTELNUMMER N° DE COMMANDE	Afm. Dim.
223LTATR	175x110x83
224LTR	220x170x120

Schroefsluiting 3/4" / Serrage à vis 3/4"



Thermoplastisch Thermoplastique

Kabeldozen

Boîtes de dérivation



BESTELNUMMER N° DE COMMANDE	Ingangen Entrées	∅	Afm. Dim.	
FE25	10	1,5-4mm	89x43x37	10/150
FE7	7	1,5-4mm	75x75x37	10/300
FE12	12	1,5-4mm	85x85x37	10/150
FE15	12	1,5-4mm	100x100x37	10/128



Met soupele ingang Avec membrane

Ronde Kabeldoos met soupele ingang

Boîte ronde de dérivation avec membrane



BESTELNUMMER N° DE COMMANDE	Afm. Dim.	
M001CS	ø 65x40 mm	1
M002CS	ø 80x40 mm	1



Kabeldoos met soupele ingang

Boîte de dérivation avec membrane





BESTELNUMMER N° DE COMMANDE	Afm. Dim.	
M003CS	80x80x40 mm	1
M005CS	94x94x50 mm	1

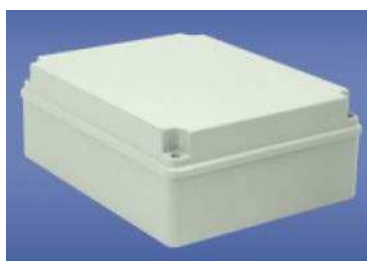

Kabeldozen PH-4A.1

Boîtes de dérivation IP65





BESTELNUMMER N° DE COMMANDE	Normes	Afm. Dim.	
28.41	IP65	248x198x96	1
28.51	IP65	348x228x142	1
28.61	IP65	400x262x140	1

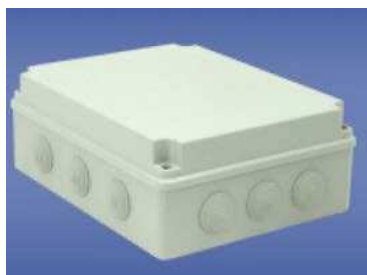

Kabeldozen met nippels PH-4A.3

Boîtes de dérivation avec entrées étanches PH-4A.3



BESTELNUMMER N° DE COMMANDE	Specificiteit Spécificités	Normes	Afm. Dim.	
28.43		IP65	248x198x96	1
28.43-PLEXI	*4		*248x198x96	1

*Met Plexi deksel - Op aanvraag

* Avec couvercle en Plexi - sur demande



Met soupele ingang Avec membrane

Kabeldozen met nippels PH-5A.3

Boîtes de dérivation avec entrées étanches PH-5A.3



BESTELNUMMER N° DE COMMANDE	Normes	Afm. Dim.	
28.53	IP65	348x228x142	1



INBOUWDOZEN BOITES D'ENCASTREMENT

Hollewanddozen

Boîtiers pour mur creux



BESTELNUMMER N° DE COMMANDE	MOD.	∅	Afm. Dim.	
424	1	68 mm	45 mm	10/310
426	1	68 mm	61 mm	10/240
428	2	68 mm	45 mm	5/130
429	3	68 mm	45 mm	5/90



Hollewanddoos vuurvast

Boîtier pour mur creux résistant au feu



BESTELNUMMER N° DE COMMANDE	∅	Afm. Dim.	
KPZ1PO	68 mm	47 mm	1

PP (halogen-free, pb-free) + foaming material
temperature resistance: -5 - +60 °C (activation of foaming material from 200 °C)
EN 1363-1:2013
EI 15 - EI 120



Universele inbouwdozen zonder Vijs

Boîtiers d'encastrement universel sans Vis



BESTELNUMMER N° DE COMMANDE	MOD.	Afm. Dim.	
430	1	60x60x50mm	10/200
431	1	60x60x65mm	10/200



Universele inbouwdozen met Vijs

Boîtiers d'encastrement universel avec Vis



BESTELNUMMER N° DE COMMANDE	MOD.	Afm. Dim.	
430V	1	60x60x50mm	10/200
431V	1	60x60x65mm	10/180



INBOUWDOZEN BOITES D'ENCASTREMENT

Inbouwdozen

Boîtiers d'encastrement



BESTELNUMMER N° DE COMMANDE	MOD.	Afm. Dim.	
316	1	75x75x42mm	10/100
318	1	75x75x60mm	10/100



VERDEELKASTEN COFFRETS DE DISTRIBUTION

Verdeelkasten opbouw Type C / IP 40 In-63A

Coffrets de distribution en saillie Type C / IP 40 In-63A



BESTELNUMMER N° DE COMMANDE	MOD.	Afm. Dim.
N4-C	1 x 4	232x139x99 mm
N8-C	1 x 8	215x236x112 mm
N12-C	1 x 12	287x236x112 mm
N18-C	1 x 18	396x236x112 mm
N24-C	2 x 12	287x361x112 mm
N36-C	3 x 12	287x485x112 mm
N2x18-C	2 x 18	396x361x112 mm
N3x18-C	3 x 18	396x526x112 mm
N48-C	4 x 12	287x651x112 mm
N4x18-C	4 x 18	651x396x112 mm

Din rail en aardingsrail inclusief en geïnstalleerd
Rail Din et barrette de terre pré-installé



Verdeelkasten inbouw Type C / IP 40 In-63A

Coffrets de distribution à encastrer Type C / IP 40 In-63A



BESTELNUMMER N° DE COMMANDE	MOD.	Afm. Dim.
U8-C	1 x 8	211x232x99 mm
U12-C	1 x 12	283x232x106 mm
U18-C	1x 18	392x232x106 mm
U24-C	2 x 12	283x357x106 mm
U36-C	3 x 12	283x482x106 mm
U2x18-C	2 x 18	392x357x106 mm
U3x18-C	3 x18	392x522x106 mm
U4-C	1 x 4	211 x 232 x 99 mm

Din rail en aardingsrail inclusief en geïnstalleerd
Rail Din et barrette de terre pré-installé



VERDEELKASTEN COFFRETS DE DISTRIBUTION

Slot voor verdeelkasten

Serrure pour coffrets de distribution



BESTELNUMMER N° DE COMMANDE	Specificiteit Spécificités
LOCKCM	Serie C

Verdeelkasten opbouw Type D / IP 65 In-63A

Coffrets de distribution en saillie Type D / IP 65 In-63A



BESTELNUMMER N° DE COMMANDE	MOD.	Afm. Dim.
N4-D	1 x 4	127x200x120 mm
N6-D	1 x 6	165x201x120 mm
N8-D	1 x 8	200x200x120 mm
N12-D	1 x 12	318x258x142 mm
N18-D	1 x 18	
N24-D	2 x 12	318x383x142 mm
N36-D	3 x 12	318x507x142 mm
N48-D	4 X 12	

Din rail en aardingsrail inclusief en geïnstalleerd
Rail Din et barrette de terre pré-installé



Vijs voor verdeelkas

Vis pour coffret de distribution



Vijs voor serie C en D
Vis pour serie C et D



VERDEELKASTEN COFFRETS DE DISTRIBUTION

Slot voor verdeelkasten

Serrure pour coffrets de distribution



BESTELNUMMER N° DE COMMANDE	Specificiteit Spécificités
LOCKDM	Serie D

Installatieset voor verdeelkast

Set d'installation pour coffret de distribution



BESTELNUMMER N° DE COMMANDE	
NSET-C-D	1

Installatie/vervangset voor serie C en D
Set d'installation/remplacement pour serie C et D

Verdeelkasten opbouw Type NEO / IP 65 In-100A

Coffrets de distribution en saillie Type NEO / IP 65 In-100A



BESTELNUMMER N° DE COMMANDE	MOD.	Afm. Dim.
RH18S	1 x 18	435x260x138 mm
RH36/2S	2 x 18	435x420x138 mm
RH54/3S	3 x 18	435x580x138 mm
RH72/4S	4 x 18	435x780x138 mm

Din rail en aardingsrail inclusief en geïnstalleerd
Rail Din et barrette de terre pré-installé



Slot voor verdeelkasten

Serrure pour coffrets de distribution



BESTELNUMMER N° DE COMMANDE	Specificiteit Spécificités
36.81	Serie NEO

VERDEELKASTEN COFFRETS DE DISTRIBUTION

Verdeelkasten opbouw IP 55 Incl. din rail

Coffrets de distribution en saillie IP 55



BESTELNUMMER N° DE COMMANDE	Ingangen Entrées	MOD.	Afm. Dim.
250-5AM	6xM20+4xM25	4 + 1	95x162x122 mm
250-9AM	6xM20+4xM25	8 + 1	98x162x202 mm
250-11AM	10xM25	10 + 1	109x232x182 mm
250-9B	10 x PG21 met Nippels	8+1	98 X 162 X 202 mm



Afdekplaatjes voor MCB - Wit - 12 modulen

Couvercles universels pour MCB - Blanc - 12 modules



BESTELNUMMER N° DE COMMANDE	Afm. Dim.	
273MF	200x52x8 mm	10



Stopcontact voor borden - DIN Rail 35 mm

Prise de courant pour tableau - DIN Rail 35mm



BESTELNUMMER N° DE COMMANDE	Stroomsterkte Ampérage	SPANNING TENSION	
C500	16A	230V	1/5

VDE -EN 50 0 22



VERDEELKASTEN COFFRETS DE DISTRIBUTION

Kabeldoorvoer Quickseal M32

Cable transit Quickseal M32



BESTELNUMMER N° DE COMMANDE	Afm. Dim.	
TPQSM32	M32	10/100



VLOERDOZEN BOÏTE POUR SOL

Vloerdozen voor toebehoren 45 x 45

Boîtes sol pour accessoires 45 x 45



BESTELNUMMER N° DE COMMANDE	MOD.	Afm. Dim.
745-4C LG	4	146x250x56 mm
745-8C LG	8	250x250x56 mm
745-CRF748	4 - 8	*

* Inlegstuk Voor Beton Voor Vloerdozen 4 En 8 Modules

* Piece d'Encastrement Pour Beton Pour Les Boites Sol 4 Et 8 Modules



Kader voor vloerdoos voor gebruik in beton / chape

Cadre pour boîte sol pour chape de béton



BESTELNUMMER N° DE COMMANDE
CFR748



Dubbele afdekplaat + 2 stekkers RJ45 CAT 6

Plaque double + 2 connecteurs RJ45 CAT6



BESTELNUMMER N° DE COMMANDE	Specificiteit Spécificités
745-LAN	CAT 6



SNELVERBINDERS CONNECTEURS RAPIDES

Universele steekklemmen

Raccords universels



BESTELNUMMER N° DE COMMANDE	
SDKF2TR-AN	100 / 2000
SDKF3TR-AN	75 / 1500
SDKF5TR-AN	50 / 1000



Steekklemmen voor harde draad

Raccords pour fil rigide



BESTELNUMMER N° DE COMMANDE	
SDK3	100 / 2000
SDK5	100 / 2000
SDK8	100 / 1000



Lusterklemmen

Raccords lustre



BESTELNUMMER N° DE COMMANDE	∅	
50704	2,5 - 4 mm ²	10/500
50706	6 mm ²	10/250
50710	10 mm ²	10/250
50716	16 mm ²	10/100
50725	25 mm ²	10/50

24A , 450V, CE, HF, PP
Wit / Blanc



SNELVERBINDERS CONNECTEURS RAPIDES

Klemstenen

Barrettes de connection



BESTELNUMMER N° DE COMMANDE	Specificiteit Spécificités	
397-5	*1	20
397-3A	*1	20
398-5	*2	20
399-5	*3	10

*1 Voor / Pour : 220A / 220B / 222A / 222B / 222L

*2 Voor / Pour : FE25 / FE7 / FE12

*3 Voor / Pour : BOX LINE



BLACK & WHITE BLACK & WHITE

Eindstuk
Embout



BESTELNUMMER N° DE COMMANDE	Afm. Dim.	
EC20 Black	20 mm	100 / 5500
EC20 White	20 mm	100 / 5500

Black = RAL 9004
White = RAL 9003



PVC Stop
Bouchon PVC



BESTELNUMMER N° DE COMMANDE	Afm. Dim.	
907M20 Black	20 mm	50 / 2000

Black = RAL 9004



Buisinvoer
Entrée tube



BESTELNUMMER N° DE COMMANDE	Afm. Dim.	
MIBR1620 Black	16/20 mm	50 / 2000
MIBR1620 White	16/20 mm	50 / 2000

White = RAL 9003
Black = RAL 9004



BLACK & WHITE BLACK & WHITE

Mof
Manchon



BESTELNUMMER N° DE COMMANDE	Afm. Dim.	
U408 White	20 mm	50 / 1600
U408 Black	20 mm	100 / 1600
U409 Black	25 mm	25 / 1125

White = RAL 9003
Black = RAL 9004



Veerkleem Black & White
Attache ressort Black & White



BESTELNUMMER N° DE COMMANDE	Afm. Dim.	
204 White	20 mm	100 / 3000
204 Black	20 mm	100 / 3000
208 Black	25 mm	50 / 1500

White = RAL 9003
Black = RAL 9004



Aaneenschuifbare drukklemmen
Attaches à pression à juxtaposer



BESTELNUMMER N° DE COMMANDE	Afm. Dim.	
2036 Black	12 - 20 mm	50 / 1500
2037 Black	16 - 26 mm	50 / 1500

Black = RAL 9004



BLACK & WHITE BLACK & WHITE

Nagelclips - Platte Kabel - Wit

Attaches à clouer - câble plat - Blanc



BESTELNUMMER N° DE COMMANDE	∅	
702-2W	2 x 1,5	100



Nagelclips - maten in mm

Attaches à clouer - mesures en mm



BESTELNUMMER N° DE COMMANDE	∅	
3007-18Black	7 mm*	100 / 12800

De 2 laatste cijfers van het bestelnummer duiden de lengte van de nagel aan. Kleur: Grijs
Les 2 derniers chiffres du n° de commande indiquent la longueur du clou. Couleur: Gris
*Zwart / Noire



Wartel

Presse-étoupe



BESTELNUMMER N° DE COMMANDE	Afm. Dim.	
BM20 White	20 mm	50 / 2000
BM20 Black	20 mm	50 / 2000

White = RAL 9003
Black = RAL 9004



BLACK & WHITE BLACK & WHITE

Boxline kabeldoos schroefingangen M20

Boxline boîte de dérivation filetage M20



BESTELNUMMER N° DE COMMANDE	Ingangen Entrées	∅	Afm. Dim.	
J100S Black	7	M20	102 ² x56 mm	1 / 90
J100S White	7	M20	102 ² x56 mm	1 / 90

White = RAL 9003

Black = RAL 9004



Kabeldoos thermoplast

Boîte de dérivation thermoplastique



BESTELNUMMER N° DE COMMANDE	Ingangen Entrées	Afm. Dim.	
FE25 Black	10	89 x 43 x 37 mm	10 / 150
FE25 White	10	89 x 43 x 37 mm	10 / 150
FE7 Black	7	75x75x37	10/300

Black = RAL 9004

White = RAL 9010

∅ 1,5-4mm



WARTELS PRESSE-ETOUPES

Wartels - Pg reeks

Presse-étoupes - Série Pg



BESTELNUMMER N° DE COMMANDE	∅	
90507	PG7	50
90509	PG9	50 / 3750
90511	PG11	50 / 2700
90513	PG13,5	50 / 2700
90516	PG16	50 / 1850
90521	PG21	20 / 1080
90529	PG29	20 / 440
90536	PG36	10 / 220
90548	PG48	5

Polystyrol

Schokbestendig / Résistant au choc

Wurtring in rubber / Bague d'échanchéité en caoutchouc

Drukrondel in gegalvaniseerd ijzer / Rondelle de pression en acier galvanisé

IP 65 – 5°C à + 60°C



Wartels met trekcontlasting - Pg reeks

Presse-étoupes à serrage - Série Pg



BESTELNUMMER N° DE COMMANDE	∅	
9707-ORL01	PG7	100
9709-ORL02	PG9	100
9711-ORL03	PG11	100
9713-ORL04	PG13,5	100
9716-ORL05	PG16	50
9721-ORL06	PG21	50
9729-ORL07	PG29	25
9736-ORL08	PG36	10
9748-ORL10	PG48	5

Polyamide met TPE rubber / Bague TPE

IP 68 –30°C à + 80°C



WARTELS PRESSE-ETOUPES

Tegenmoeren - Pg reeks

Contre-écrous - Série Pg



BESTELNUMMER N° DE COMMANDE	∅	
90607	PG7	50
90609	PG9	50
90611	PG11	50
90613	PG13,5	50 / 5600
90616	PG16	50 / 5600
90621	PG21	20 / 2240
90629	PG29	20 / 2240
90636	PG36	10
90648	PG48	10

Polystyrol / Polystyrene
Schokbestendig / Résistant au choc
- 5°C à + 60°C
DIN 46320 - L



Stoppen - Pg reeks

Bouchons - Série Pg



BESTELNUMMER N° DE COMMANDE	∅	
90707	PG7	100
90709	PG9	100
90711	PG11	100
90713	PG13,5	50
90716	PG16	50
90721	PG21	50
90729	PG29	50
90736	PG36	50
90748	PG48	25

Polystyrol / Polystyrene
Schokbestendig / Résistant au choc
- 5°C à + 60°C
DIN 46320 - N



WARTELS PRESSE-ETOUPES

Wartels - Metrische reeks

Presse-étoupes - Série Métrique IP54



BESTELNUMMER N° DE COMMANDE	∅	
905M12-DMRL01	12 mm	50
905M16-DMRL03	16 mm	100
905M20-DMRL04	20 mm	100
905M25-DMRL06	25 mm	50

Polyamide / IP 54 / -30°C /+80°C,
TPV Rubber / Bague TPV, EN60423



Wartels met trekontlasting - Metrische reeks IP68

Presse-étoupes à serrage - Série Métrique IP68



BESTELNUMMER N° DE COMMANDE	∅	
BM12	12 mm	50 / 2000
BM16	16 mm	50 / 2000
BM20	20 mm	50 / 2000
BM25	25 mm	20 / 800
BM32	32 mm	20 / 600
BM40	40 mm	10 / 300
BM50	50 mm	5 / 200
BM63	63 mm	5 / 120

Met skintop en trekontlasting
Avec skintop et serrage étendu
Polyamide / IP 68 / -20°C /+125°C



Wartels MULTIHOLE met trekontlasting - Metrische reeks IP65

Presse-étoupes MULTIHOLE à serrage - Série Métrique IP6

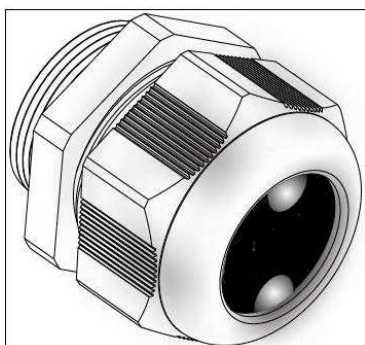

BESTELNUMMER N° DE COMMANDE	Ingangen Entrées	∅
OMRL05A7	2 x 7 mm	M20

IP65, -30°C /+80°C, RAL7035
Andere configuraties op aanvraag
Autres configurations sur demande



WARTELS PRESSE-ETOUPES

Wartels met trekontlasting

Presse-étoupes à serrage - Série Métrique



BESTELNUMMER N° DE COMMANDE	∅	
OMRL03 M16	M16 (5-10 mm)	150 / 2500
OMRL05 M20	M20 (10-14 mm)	150 / 2500
OMRL09 M50	M50	100 / 1600
OMRL10 M63	M63	100 / 1600

Polyamide / IP 68
-30°C / +80°C,
TPV Rubber / Bague TPV, EN50262, RAL7035, VDE
RAL7035
Einde Reeks/Fin de série



Tegenmoeren - Metrische reeks

Contre-écrous - Série Métrique



BESTELNUMMER N° DE COMMANDE	∅	
PM12	12 mm	50/4800
PM16	16 mm	50/4800
PM20	20 mm	50/4800
PM25	25 mm	20/1920
PM32	32 mm	20/1920
PM40	40 mm	10/960
PM50	50 MM	10/480
PM63	63 MM	5/480

Polyamide
RAL7035
- 20°C / +125°C



Tegenmoeren - Metrische reeks

Contre-écrous - Série Métrique



BESTELNUMMER N° DE COMMANDE	∅
OMSL01	12 mm
OMSL02	16 mm

Polyamide (30% Glassfiber)
RAL7035
- 30°C / +80°C



WARTELS PRESSE-ETOUPES

Tegenmoeren - Metrische reeks

Contre-écrous - Série Métrique



BESTELNUMMER N° DE COMMANDE	∅
OMSL03	20 mm
OMSL04	25 mm
OMSL05	32 mm
OMSL06	40 mm
OMSL07	50 mm
OMSL08	63 mm

Polyamide (30% Glassfiber)

RAL7035

- 30°C / +80°C



Stoppen - Metrische reeks

Bouchons - Série Métrique



BESTELNUMMER N° DE COMMANDE	∅	
907M12	12 mm	100
907M16	16 mm	100
907M20	20 mm	100
907M25	25 mm	25
907M32	32 mm	20
907M40	40 mm	10
907M50	50 mm	4
907M63	63 mm	4

Polyamide

RAL7035

- 30°C / +80°C



Wurgnippels - Metrische reeks

Raccords à visser - Série Métrique



BESTELNUMMER N° DE COMMANDE	∅	
908M16	16 mm	100
908M20	20 mm	100

Polyamide

RAL7035

- 30°C / +80°C



WARTELS PRESSE-ETOUPES

Wurgnippels - Metrische reeks

Raccords à visser - Série Métrique



BESTELNUMMER N° DE COMMANDE	∅	
908M25	25 mm	100
908M32	32 mm	50
908M40	40 mm	25
908M50	50 mm	10

Polyamide
RAL7035
- 30°C / +80°C



Drukmoeren - Metrische reeks

Boulons de pression - Série Métrique



BESTELNUMMER N° DE COMMANDE	∅	
909M16	16 mm	100
909M20	20 mm	100



Vergrotingen - Metrische reeks

Augmentations - Série Métrique



BESTELNUMMER N° DE COMMANDE	∅ BINNEN ∅ NTERNE	∅	
ME1216	M16	M12	100
ME1620	M20	M16	100
ME2025	M25	M20	100
ME2532	M32	M25	50
ME3240	M40	M32	50

Polystyrol / IP 65 / - 5°C / + 60°C



WARTELS PRESSE-ETOUPES

Verkleiningen - Metrische reeks

Réductions - Série Métrique



BESTELNUMMER N° DE COMMANDE	∅ BINNEN ∅ NTERNE	∅	
MR1612	M12	M16	100
MR2012	M12	M20	100
MR2016	M16	M20	100
MR2512	M12	M25	100
MR2516	M16	M25	100
MR2520	M20	M25	100
MR3212	M12	M32	50
MR3216	M16	M32	50
MR3220	M20	M32	50
MR3225	M25	M32	50
MR4016	M16	M40	50
MR4020	M20	M40	50
MR4025	M25	M40	50
MR4032	M32	M40	50
MR5020	M20	M50	25
MR5025	M25	M50	25
MR5032	M32	M50	25
MR5040	M40	M50	25
MR6325	M25	M63	25
MR6332	M32	M63	25
MR6340	M40	M63	25
MR6350	M50	M63	25



SUPER T SUPER T

Aaneenschuifbare klem SUPER T

Attache à juxtaposer SUPER T



BESTELNUMMER N° DE COMMANDE	∅	
ST16	16 mm	100/3000
ST20	20 mm	100/3000
ST25	25 mm	100/3000
ST32	32 mm	100/3000
ST40	40 mm	50/1500

M6 Polyamide

Kleur : grijs

Couleur : gris



Deksel voor SUPER T

Couvercle pour SUPER T



BESTELNUMMER N° DE COMMANDE	Afm. Dim.	
STC16	16 mm	100/9600
STC20	20 mm	100/9600
STC25	25 mm	100/9600
STC32	32 mm	100/9600
STC40	40 mm	50/4800



Plug M6 voor veer- en drukklommen

Cheville M6 pour attaches ressort et à pression



BESTELNUMMER N° DE COMMANDE	
20436	100

M6 Polyamide

Kleur : grijs

Couleur : gris

3 posities / 3 positions



SUPER T SUPER T

Plug M6 voor veer- en drukklemmen

Cheville M6 pour attaches ressort et à pression

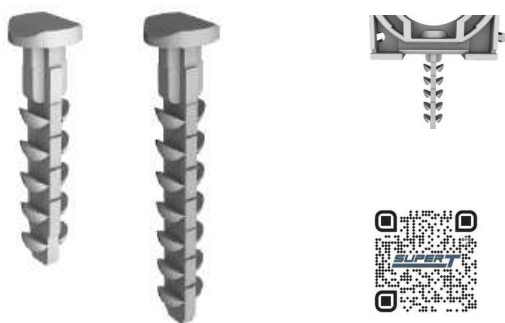

BESTELNUMMER N° DE COMMANDE	Specificiteit Spécificités	
PST-5	27 mm	100/9600
PST-7	42 mm	100/9600

M6 Polyamide
Kleur : grijs
Couleur : gris
1 positie / 1 position



Montageplug M6 voor beton voor klem SUPER T

Cheville de montage M6 pour béton pour SUPER T



BESTELNUMMER N° DE COMMANDE	Afm. Dim.	
PSTB-4	27 mm	100/9600
PSTB-7	42 mm	100/9600

M6 Polyamide
Kleur : grijs
Couleur : gris
10 posities / 10 positionS



Montageplug voor metalen plaat voor klem SUPER T

Cheville de montage pour plaque de métal pour SUPER T



BESTELNUMMER N° DE COMMANDE	
ST-CLIP	100/14400

Polyamide
Kleur : grijs
Couleur : gris
10 posities / 10 positionS
Ook voor kabelbinders / aussi pour colliers de câblage



SUPER T SUPER T

Montageplug voor gebruik met siliconen voor klem SUPER T

Cheville de montage pour usage avec silicon pour SUPER T

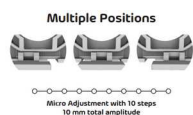
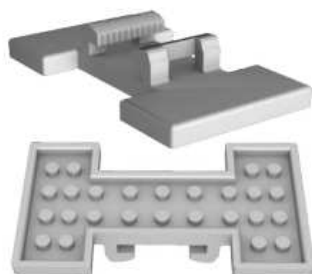

BESTELNUMMER
N° DE COMMANDE



ST-BASE

100/9600

Polyamide

Kleur : grijs

Couleur : gris

10 posities / 10 positionS

Ook voor kabelbinders / aussi pour colliers de câblage



VEERKLEMMEN ATTACHES RESSORT

veerklemmen

Attaches ressort



BESTELNUMMER N° DE COMMANDE	∅	
108	50 mm	25 / 600

M6 Polyamide
Kleur : grijs
Couleur : gris



Aaneenschuifbare veerklemmen

Attaches ressort à juxtaposer



BESTELNUMMER N° DE COMMANDE	∅	
211	16 mm	100 / 4000
204	20 mm	100 / 3000
208	25 mm	50 / 1500
209	32 mm	50 / 1500
210	40 mm	25 / 750

M6 Polyamide
Kleur : grijs
Couleur : gris



Aaneenschuifbare drukklemmen

Attaches pression à juxtaposer



BESTELNUMMER N° DE COMMANDE	∅	
2035	6 - 13 mm	50 / 3750
2036	12 - 20 mm	50 / 1500
2037	16 - 26 mm	50 / 1500
2038	18 - 30 mm	50 / 1200
2039	27 - 43 mm	25 / 750

M6 Polyamide
Kleur : grijs
Couleur : gris



VEERKLEMMEN ATTACHES RESSORT

Universele klemmen

Attaches universelles



BESTELNUMMER N° DE COMMANDE	∅	
031G	16 - 22 mm	50 / 2700
031T	16 - 22 mm	50 / 2700

Kleur : Grijs of transparant
Couleur : Gris ou transparent



Veerklem met Plug M6

Attache Ressort avec Cheville M6

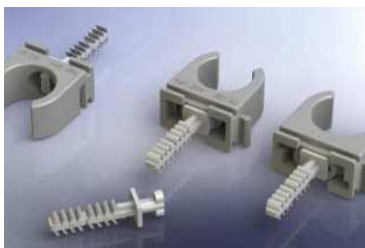

BESTELNUMMER N° DE COMMANDE	∅	
204D	20 mm	50/2000
211D	16 mm	100/4000

M6 Polyamide
Kleur : grijs
Couleur : gris



Drukklem met Plug M6

Attaches pression avec Cheville M6

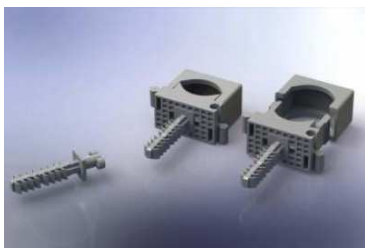

BESTELNUMMER N° DE COMMANDE	∅	
2036D	12 - 20 mm	50 / 1500
2037D	16 - 24 mm	50 / 1200

M6 Polyamide
Kleur : grijs
Couleur : gris



KLEMMEN ATTACHES

Vorkklemmen

Attaches fourchette



BESTELNUMMER N° DE COMMANDE	∅	
512	10 mm	100/1000
513	12 mm	100/1000
514	13,5 - 15 mm	100/5400
515	14 - 15 mm	100/1000
516	16 - 18 mm	50/2500
517	20 - 22 mm	50/2500
518	22 - 25 mm	50/2700
519	35 mm	30/1080
520	42 mm	20/720

M6 Polyamide
Grijs / gris



Vorkklemmen dubbel

Attaches fourchette double



BESTELNUMMER N° DE COMMANDE	∅	
512-2	10 mm	50/500
513-2	12 mm	50/1000
515-2	14 - 15 mm	50/1000
516-2	16 - 18 mm	25/1350
517-2	20 - 22 mm	25/1350
518-2	25 - 28 mm	20/720

Voor gelijktijdige bevestiging van 2 kabels of buizen
Pour fixation simultane de 2 cables ou tubes

M6 Polyamide
Grijs / gris



KZM kabelzadels

KZM attaches



BESTELNUMMER N° DE COMMANDE	∅	
905	5 - 14 mm	100/4000

Polypropyleen/Polypropylène
Vijs in polystyrol/Vis en polystyrol



KLEMMEN ATTACHES

KZM kabelzadels

KZM attaches



BESTELNUMMER N° DE COMMANDE	∅	
906	6 - 17 mm	50/2000
907	15 - 25 mm	50/1200
908	24 - 34 mm	25/750

Polypropyleen/Polypropylène
Vijs in polystyrol/Vis en polystyrol



KZM kabelzadels dubbel

KZM attaches double



BESTELNUMMER N° DE COMMANDE	∅	
906-2	6 - 17 mm	50/1500

Polypropyleen/Polypropylène
Vijs in polystyrol/Vis en polystyrol



Kabelhouder

Attaches câble



BESTELNUMMER N° DE COMMANDE	Normes	Afm. Dim.
710-15	Max. 10kg	38x69 mm
710-30	Max. 10kg	42x106 mm



Slagklemmen

Attaches intercalaires



BESTELNUMMER N° DE COMMANDE	∅	
2047	5 - 25 mm	100 / 5400
2048	8 - 38 mm	100 / 3000

Snelle montage voor rail 761 & 2761
Fixation rapide pour rail 761 & 2761



KLEMMEN ATTACHES

Railklemmen

Attaches pour rail avec vis



BESTELNUMMER N° DE COMMANDE	∅	
2050	7 - 25 mm	100 / 5400
2051	13 - 38 mm	100 / 3000

Voor rail 761 & 2761
Pour rail 761 & 2761



Aaneenschuifbare 'Clic' klemmen

Attaches 'Clic' à juxtaposer



BESTELNUMMER N° DE COMMANDE	∅	
701516	15 - 16 mm	50/1350
701920	20 - 22 mm	50/900
702225	25 - 28 mm	50/400
703235	32 - 35 mm	50/800



SNELMONTAGE FIXATION RAPIDE

Universele nagelclips
Clips à clouer universels



BESTELNUMMER N° DE COMMANDE	∅	
700-02	2,5 - 4 mm	100 /12800
700-05	5 - 7 mm	100 /12800
700-08	8 - 10 mm	100 /9600
700-11	11 - 15 mm	100 /7500
700-16	16 - 19 mm	50 /2000
700-23	23 - 29 mm	50 /250
700-08 Black	8 - 10 mm *	100 /9600

Met slechts 6 types alle maten in voorraad. Kleur: Grijs
Avec seulement 6 types toutes dimensions en stock. Couleur:
Gris
* Black



Nagelclips - maten in mm
Attaches à clouer - mesures en mm



BESTELNUMMER N° DE COMMANDE	∅	
3004-18	4 mm	100 /12800
3005-18	5 mm	100 /12800
3006-18	6 mm	100 /12800
3007-18	7 mm	100 /12800
3008-20	8 mm	100 /12800
3009-20	9 mm	100 /12800
3010-35	10 mm	100 /12800
3011-35	11 mm	100 /12800
3012-35	12 mm	50 / 6400
3014-40	14 mm	50 / 5400
3016-40	16 mm	25 / 3250
3018-40	18 mm	25 / 3200
3020-40	20 mm	25 / 3200
3007-18Black	7 mm*	100 /12800

De 2 laatste cijfers van het bestelnummer duiden de lengte van de nagel aan. Kleur: Grijs
Les 2 derniers chiffres du n° de commande indiquent la longueur du clou. Couleur: Gris
*Zwart / Noire



SNELMONTAGE FIXATION RAPIDE

Nagelclips - maten in mm

Attaches à clouer - mesures en mm



BESTELNUMMER N° DE COMMANDE	∅ BINNEN ∅ NTERNE	
OL70211	3/4 mm	100 / 10000
OL70212	5/6 mm	100 / 10000
OL70213	7/8 mm	100 / 10000
OL70214	9/10 mm	100 / 10000
OL70215	11/12 mm	100 / 10000
OL70216	13/14 mm	100 / 5000
OL70217	15/16 mm	100 / 4000
OL70218	19/20 mm	100 / 3000



Nagelclips - Platte Kabel

Attaches à clouer - câble plat



BESTELNUMMER N° DE COMMANDE	∅	
702-0	2 x 0,75	100 / 2000
702-1	2 x 1	100 / 2000
702-2	2 x 1,5	100 / 1000
702-3	2 x 2,5	100 / 1000



Plugclips met nagel

Clips cheville avec clou



BESTELNUMMER N° DE COMMANDE	∅	
300620W	16 - 19 mm	200 / 3200
300720W	16 - 19 mm	100 / 1600



SNELMONTAGE FIXATION RAPIDE

Plugclips in PVC - Enkel

Clips cheville en PVC - Simple



BESTELNUMMER N° DE COMMANDE	Ingangen Entrées	∅	
601620	1	16 - 20 mm	200 / 6000
601922	1	19 - 22 mm	125 / 3750
602125	1	21 - 25 mm	125 / 3750

Snelle betonmontage / Fixation beton rapide
Kleur : wit / Couleur : blanc



Plugclips in PVC - Dubbel

Clips cheville en PVC - Double



BESTELNUMMER N° DE COMMANDE	Ingangen Entrées	∅	
611620	2	16 - 20 mm	125 / 3750
611922	2	19 - 22 mm	75 / 2250
612125	2	21 - 25 mm	60 / 1800

Snelle betonmontage / Fixation beton rapide
Kleur : wit / Couleur : blanc



Plugclips in PVC - dubbel

Clips cheville en PVC - Double



BESTELNUMMER N° DE COMMANDE	Ingangen Entrées	∅	
411620	2	16 - 20 mm	120 / 3600

Snelle betonmontage / Fixation beton rapide
Kleur : wit / Couleur : blanc



Pluggen

Chevilles



BESTELNUMMER N° DE COMMANDE	∅	
SEL712006	6 mm	100 / 4000
SEL712008	8 mm	100 / 2500
SEL712010	10 mm	50 / 1250
SEL712012	12 mm	25 / 625

SNELMONTAGE FIXATION RAPIDE

High cavity pluggen - met kraag

Chevilles à haute traction - avec collerette

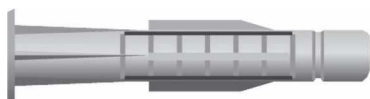

BESTELNUMMER N° DE COMMANDE	∅	
SELRXO101	6 x 35 mm	100 / 1800
SELRXO102	8 x 50 mm	50 / 900

High cavity pluggen / Chevilles à haute traction

Nylon plug voor gipsplaten

Cheville Nylon pour plaques de plâtre



BESTELNUMMER N° DE COMMANDE	∅	
SELCGO101	12,3 x 29 mm	100 / 4000

Nylon plug met houtvijs kruis

Cheville Nylon avec visse en croix



BESTELNUMMER N° DE COMMANDE	∅	
SELPXV101	6 x 60 mm	100 / 900

Nylon slagplug kruis

Cheville Nylon à frapper



BESTELNUMMER N° DE COMMANDE	∅	
SELCXP102	5 X 30 mm	100 / 2000
SELCXP104	5 X 40 mm	100 / 2000
SELCXP106	6 x 40 mm	100 / 2000

KABELBINDERS COLLIERS DE CÂBLAGE

Zwart

Noir



BESTELNUMMER N° DE COMMANDE	Afm. Dim.	
SEL3201	75 x 2,5	100 / 5000
SEL3202	100 x 2,5	100 / 5000
SEL3203	135 x 2,5	100 / 5000
SEL3204	160 x 2,5	100 / 5000
SEL3205	200 x 2,5	100 / 5000
SEL3210	140 x 3,5	100 / 5000
SEL3211	200 x 3,5	100 / 5000
SEL3216	250 x 3,5	100 / 5000
SEL3212	280 x 3,5	100 / 5000
SEL3214	360 x 3,5	100 / 4000
SEL3220	140 x 4,5	100 / 5000
SEL3221	160 x 4,5	100 / 5000
SEL3222	180 x 4,5	100 / 5000
SEL3223	200 x 4,5	100 / 5000
SEL3224	250 x 4,5	100 / 5000
SEL3425	280 x 4,5	100 / 5000
SEL3429	300 x 4,5	100 / 4000
SEL3426	360 x 4,5	100 / 4000
SEL3427	380 x 4,5	100 / 3500
SEL3428	430 x 4,5	100 / 2500
SEL3447	360 x 6,0	100 / 1500
SEL3430	180 x 7,5	100 / 2500
SEL3431	240 x 7,5	100 / 2000
SEL3432	200 X 7,5	100 / 5000
SEL3433	280 x 7,5	100 / 2000
SEL3438	320 x 7,5	100 / 1500
SEL3434	360 x 7,5	100 / 1500
SEL2435	450 x 7,5	100 / 2500
SEL3436	500 x 7,5	100 / 1000
SEL3441	750 x 7,5	100 / 700
SEL3144	430 x 9,0	100 / 1000
SEL3142	550 x 9,0	100 / 700
SEL3143	780 x 9,0	100 / 500
SEL3155	1220 x 9,0	100 / 500

Nylon PA 6.6



KABELBINDERS COLLIERS DE CÂBLAGE

Zwart

Noir



BESTELNUMMER N° DE COMMANDE	Afm. Dim.	
SEL3150	250 x 12,5	50 / 500
SEL3451	500 x 12,5	50 / 500
SEL3452	750 x 12,5	50 / 500
SEL3453	1000 x 12,5	50 / 500

Nylon PA 6.6



Wit

Blanc



BESTELNUMMER N° DE COMMANDE	Afm. Dim.	
SEL2201	75 x 2,5	100 / 5000
SEL2202	100 x 2,5	100 / 5000
SEL2203	135 x 2,5	100 / 5000
SEL2204	160 x 2,5	100 / 5000
SEL2205	200 x 2,5	100 / 5000
SEL2210	140 x 3,5	100 / 5000
SEL2211	200 x 3,5	100 / 5000
SEL3215	225 x 3,5	100 / 5000
SEL2216	250 x 3,5	100 / 5000
SEL2212	280 x 3,5	100 / 5000
SEL2214	360 x 3,5	100 / 4000
SEL2220	140 x 4,5	100 / 5000
SEL2221	160 x 4,5	100 / 5000
SEL2222	180 x 4,5	100 / 5000
SEL2223	200 x 4,5	100 / 5000
SEL2224	250 x 4,5	100 / 5000
SEL2425	280 x 4,5	100 / 5000
SEL2429	300 x 4,5	100 / 4000
SEL2426	360 x 4,5	100 / 4000
SEL2427	380 x 4,5	100 / 3500
SEL2428	430 x 4,5	100 / 2500
SEL2447	360 X 6,0	50 / 500
SEL2430	180 x 7,5	100 / 2500

Nylon PA 6.6



KABELBINDERS COLLIERS DE CÂBLAGE

Wit
Blanc



BESTELNUMMER N° DE COMMANDE	Afm. Dim.	
SEL2432	200 x 7,5	100 / 5000
SEL2431	240 x 7,5	100 / 2000
SEL2433	280 x 7,5	100 / 2000
SEL2438	320 x 7,5	100 / 1500
SEL2434	360 x 7,5	100 / 1500
SEL2435	450 x 7,5	100 / 2500
SEL2436	500 x 7,5	100 / 1000
SEL3437	540 x 7,5	100 / 2500
SEL2441	750 x 7,5	100 / 700
SEL2144	430 x 9,0	100 / 1000
SEL2142	550 x 9,0	100 / 700
SEL2143	780 x 9,0	100 / 500
SEL2155	1220 x 9,0	100 / 500
SEL2450	250 x 12,5	50 / 500
SEL2451	500 x 12,5	50 / 500
SEL2452	750 x 12,5	50 / 500
SEL2453	1000 x 12,5	50 / 500

Nylon PA 6.6



Kabelbinders gekleurd
Colliers de câblage colorés



BESTELNUMMER N° DE COMMANDE	Afm. Dim.	KLEUR	COULEUR	
SEL10202R	100 x 2,5	Rood	Rouge	100 / 5000
SEL10210R	140 x 3,5	Rood	Rouge	100 / 5000
SEL10223R	200 x 4,5	Rood	Rouge	100 / 5000
SEL10425R	280 x 4,5	Rood	Rouge	100 / 5000
SEL11202R	100 x 2,5	Blauw	Bleu	100 / 5000
SEL11210R	140 x 3,5	Blauw	Bleu	100 / 5000
SEL11223R	200 x 4,5	Blauw	Bleu	100 / 5000

Rood / Rouge RAL 3000

Blauw / Bleu RAL 5002

Groen / Vert RAL 6024

Geel / Jaune RAL 1201

Nylon PA 6.6



KABELBINDERS COLLIERS DE CÂBLAGE

Kabelbinders gekleurd

Colliers de câblage colorés

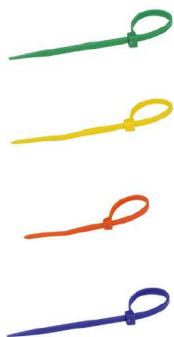

BESTELNUMMER N° DE COMMANDE	Afm. Dim.	KLEUR	COULEUR	
SEL11425R	280 x 4,5	Blauw	Bleu	100 / 5000
SEL12202R	100 x 2,5	Groen	Vert	100 / 5000
SEL12210R	140 x 3,5	Groen	Vert	100 / 5000
SEL12223R	200 x 4,5	Groen	Vert	100 / 5000
SEL12425R	280 x 4,5	Groen	Vert	100 / 5000
SEL14202R	100 x 2,5	Geel	Jaune	100 / 5000
SEL14210R	140 x 3,5	Geel	Jaune	100 / 5000
SEL14223R	200 x 4,5	Geel	Jaune	100 / 5000
SEL14425R	280 x 4,5	Geel	Jaune	100 / 5000

Rood / Rouge RAL 3000

Blauw / Bleu RAL 5002

Groen / Vert RAL 6024

Geel / Jaune RAL 1201

Nylon PA 6.6



Kabelstrip wit - met markeerplaat 8 x 25 mm

Collier blanc - avec plaquette d'identification 8 x 25 mm



BESTELNUMMER N° DE COMMANDE	Afm. Dim.	
SEL.2.202T	100 x 2,5	100 / 5000

Nylon PA 6.6



Centuring Polyamide 12

Centuring Polyamide 12



BESTELNUMMER N° DE COMMANDE	Afm. Dim.	
SEL3320	180 x 9	100 / 3500
SEL3321	265 x 9	100 / 2000
SEL3322	360 x 9	100 / 1400
SEL3323	500 x 9	100 / 1000
SEL3324	750 x 9	100 / 1000



KABELBINDERS COLLIERS DE CÂBLAGE

Nylon binders met Inox tand - naturel

Colliers en nylon avec dent en acier Inox - naturel



BESTELNUMMER N° DE COMMANDE	Afm. Dim.	
MET22102R	100 x 2,5	100
MET22105R	200 x 2,5	100
MET22110R	140 x 3,5	100
MET22111R	200 x 3,5	100
MET22112R	280 x 3,5	100
MET22123R	200 x 4,5	100
MET22126R	360 x 4,5	100
MET22140R	290 x 4,5	100
MET22534R	360 x 7,5	100



Nylon binders met Inox tand - zwart

Colliers en nylon avec dent en acier Inox - noir



BESTELNUMMER N° DE COMMANDE	Afm. Dim.	
MET32102R	100 x 2,5	100
MET32105R	200 x 2,5	100
MET32110R	140 x 3,5	100
MET32111R	200 x 3,5	100
MET32112R	280 x 3,5	100
MET32123R	200 x 4,5	100
MET32126R	360 x 4,5	100
MET32326R	360 X 4,5	100
MET32140R	290 x 4,5	100
MET32534R	360 x 7,5	50



Click Tie - herbruikbaar - Rood

Click Tie - réouvrable et réutilisable - Rouge



BESTELNUMMER N° DE COMMANDE	Afm. Dim.	
CLT102110R	120 x 3,5	100 / 5000
CLT102116R	240 x 3,8	100 / 5000
CLT102129R	320 x 4,4	100 / 5000



KABELBINDERS COLLIERS DE CÂBLAGE

Click Tie - herbruikbaar - Rood

Click Tie - réouvrable et réutilisable - Rouge



BESTELNUMMER N° DE COMMANDE	Afm. Dim.	
CLT102149R	500 x 5,6	100 / 5000



Plug voor kabelbinders M8

Cheville pour colliers de serrage M8



BESTELNUMMER N° DE COMMANDE	
MF111	100 / 3500

Plug voor kabelbinders tot 9 mm breed.
Cheville pour collier de serrage jusqu'à 9 mm de largeur.



Zelfklevende 2-weg consoles

Consoles adhésives double direction



BESTELNUMMER N° DE COMMANDE	Afm. Dim.	
SEL2501	ø 20 mm	100 / 3000
SEL2502	ø 28 mm	100 / 3000



Identificatieplaatje

Plaquette d'identification



BESTELNUMMER N° DE COMMANDE	Afm. Dim.	
SEL101	20x40x1,3mm	100 / 3000



KABELBINDERS COLLIERS DE CÂBLAGE

Klipconsoles 'Hooks' zelfklevend
Consoles clips 'Hooks' adhésives



BESTELNUMMER N° DE COMMANDE	Afm. Dim.	
SEL2401	10 x 19	100 / 3000
SEL2402	13 x 26	100 / 3000
SEL2403	18 x 26	100 / 3000



PVC KANALEN CANAUX PVC

Type E - 6-6,5 mm - LSOH

Type E - 6-6,5 mm - LSOH

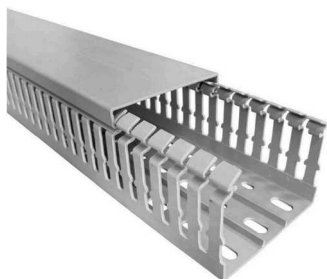

BESTELNUMMER N° DE COMMANDE	Afm. Dim.	
V6H2525	25 x 25 mm	50
V6H4025	25 x 40 mm	48
V6H4040	40 x 40 mm	50
V6H4060	60 x 40 mm	50
V6H4080	80 x 40 mm	30
V6H6025	25 x 60 mm	60
V6H6040	40 x 60 mm	40
V6H6060	60 x 60 mm	24
V6H6080	80 x 60 mm	20
V6H60100	100 x 60 mm	16
V6H60120	120 X 60 mm	12
V6H8025	25 x 80 mm	20
V6H8040	40 x 80 mm	20
V6H8060	60 x 80 mm	20
V6H8080	80 x 80 mm	12
V6H80100	100 x 80 mm	12
V6H80120	120 x 80 mm	16
V6H10060	60 x 100 mm	16
V6H10080	80 x 100 mm	16
V6H100100	100 x 100 mm	12

Lengte : 2 meter Kleur :

Grijs RAL 7035

Deksel inbegrepen

Longueur : 2 mètres

Couleur : Gris RAL 7035

Couvercle inclus



MINIKANALEN MINI GOULOTTE

TYPE INWAY LSOH

TYPE INWAY LSOH



BESTELNUMMER N° DE COMMANDE	Afm. Dim.	RAL	
IW2012.5BLH	20 x 12,5 mm	RAL 9010	80m
IW2020LH	20 x 20 mm	RAL 9010	50m
IW4017LH	40 X 17 mm	RAL 9010	30m
IW4040BLH	40 x 40 mm	RAL 9010	46m
IW6040LH	60 x 40 mm	RAL 9010	32m

Deksel inbegrepen
Lengte : 2 meter
Couvercle inclus
Longueur : 2 mètres



MINIKANALEN MINI GOULOTTE

Mini Inway - Toebehoren

Mini Inway - Accessoires



BESTELNUMMER N° DE COMMANDE	OMSC.	DESC.	Afm. Dim.
IWAE2012B	Buitenhoek	Angle extérieur	20 x 12,5 mm
IWAE4017B	Buitenhoek	Angle extérieur	40 x 17 mm
IWAI2012B	Binnenhoek	Angle intérieur	20 x 12,5 mm
IWAI4017B	Binnenhoek	Angle intérieur	40 x 17 mm
IWAP2012B	Vlakke hoek	Angle Plat	20 x 12,5 mm
IWAP4017B	Vlakke hoek	Angle Plat	40 x 17 mm
IWGT2012B	T	Dérivation "T"	20 x 12,5 mm
IWGT4017B	T	Dérivation "T"	40 x 17 mm
IWGU2012B	Koppelstuk	Joint	20 x 12,5 mm
IWGU4017B	Koppelstuk	Joint	40 x 17 mm
IWTT2012B	Eindstuk	Embout	20 x 12,5 mm
IWTT4017B	Eindstuk	Embout	40 x 17 mm



TYPE INWAY BLACK LSOH

TYPE INWAY BLACK LSOH



BESTELNUMMER N° DE COMMANDE	Afm. Dim.	RAL	
IW2012.5LHBlack	20 X 12,5 mm	RAL 9005	80 m
IW4017LHBlack	40 x 17 mm	RAL 9005	30 m

Deksel inbegrepen
Lengte : 2 meter
Couvercle inclus
Longueur : 2 mètres



MINIKANALEN MINI GOULOTTE

Mini Inway Black - Toebehoren

Mini Inway Black - Accessoires



BESTELNUMMER N° DE COMMANDE	OMSC.	DESC.	Afm. Dim.
IWAE2012Black	Buitenhoek	Angle extérieur	20 x 12,5 mm
IWAE4017Black	Buitenhoek	Angle extérieur	40 x 17 mm
IWAI2012Black	Binnenhoek	Angle intérieur	20 x 12,5 mm
IWAI4017Black	Binnenhoek	Angle intérieur	40 x 17 mm
IWAP2012Black	Vlakke hoek	Angle Plat	20 x 12,5 mm
IWAP4017Black	Vlakke hoek	Angle Plat	40 x 17 mm
IWGT2012Black	"T" stuk	Dérivation "T"	20 x 12,5 mm
IWGT4017Black	"T" stuk	Dérivation "T"	40 x 17 mm
IWGU2012Black	Koppelstuk	Joint	20 x 12,5 mm
IWGU4017Black	Koppelstuk	Joint	40 x 17 mm
IWTT2012Black	Eindstuk	Embout	20 x 12,5 mm
IWTT4017Black	Eindstuk	Embout	40 x 17 mm



LHD

LHD



BESTELNUMMER N° DE COMMANDE	Afm. Dim.	RAL	
LHD2010HF	20 x 10 mm	RAL 9003	96 m

Deksel inbegrepen

Lengte : 2 meter

Couvercle inclus

Longueur : 2 mètres

LIJST VAN DE TOEBEHOREN - ZIE WWW.GSV.BE

LISTE DES ACCESSOIRES - SUR WWW.GSV.BE



MINIKANALEN MINI GOULOTTE

LHD

LHD



BESTELNUMMER N° DE COMMANDE	Afm. Dim.	RAL	
LHD2020HF	20 x 20 mm	RAL 9003	48 m
LHD4020HF	40 x 20 mm	RAL 9003	24 m
LHD4040HF	40 x 40 mm	RAL 9003	20 m

Deksel inbegrepen

Lengte : 2 meter

Couvercle inclus

Longueur : 2 mètres

LIJST VAN DE TOEBEHOREN - ZIE WWW.GSV.BE

LISTE DES ACCESSOIRES - SUR WWW.GSV.BE



Buithoek

Angle extérieur



BESTELNUMMER N° DE COMMANDE	Afm. Dim.	
LHD8926HF	20 x 10 mm	1/10
LHD8626HF	20 x 20 mm	1/10
LHD8636HF	40 x 20 mm	1/10
LHD8646HF	40 x 40 mm	1/10



Binnenhoek

Angle intérieur



BESTELNUMMER N° DE COMMANDE	Afm. Dim.	
LHD8925HF	20 x 10 mm	1/10
LHD8625HF	20 x 20 mm	1/10
LHD8635HF	40 x 20 mm	1/10
LHD8645HF	40 x 40 mm	1/10
SAI160BEU	160 mm	1/10



MINIKANALEN MINI GOULOTTE

Vlakke hoek

Angle plat



BESTELNUMMER N° DE COMMANDE	Afm. Dim.	
LHD8923HF	20 x 10 mm	1/10
LHD8623HF	20 x 20 mm	1/10
LHD8633HF	40 x 20 mm	1/10
LHD8643HF	40 x 40 mm	1/10



T-stuk

Déviat-ion-T



BESTELNUMMER N° DE COMMANDE	Afm. Dim.	
LHD8924HF	20 x 10 mm	1/10
LHD8624HF	20 x 20 mm	1/10
LHD8634HF	40 x 20 mm	1/10
LHD8644HF	40 x 40 mm	1/10



WANDKANALEN INWAY GOULOTTES INWAY

Wandkanalen LSOH

Goulotte LSOH

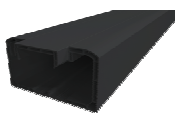
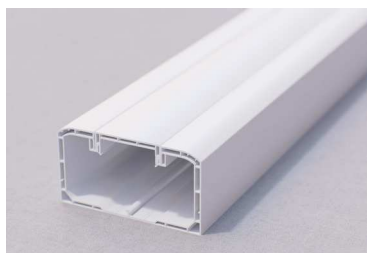

BESTELNUMMER N° DE COMMANDE	Afm. Dim.	RAL	
IW10054BLH	100 x 54 mm	RAL9003	12 m
IW10054LHBLACK	100 x 54 mm	RAL9005	12 m

Deksel inbegrepen
Lengte : 2 meter
Couvercle inclus
Longueur : 2 mètres



WANDKANALEN INWAY GOULOTTES INWAY

Toebehoren Wandkanalen INWAY

Accessoires Goulottes Murales INWAY



BESTELNUMMER N° DE COMMANDE	OMSC.	DESC.	
IWAE10054B	Verstelbare buitenhoek	Angle extérieur flexible	6
IWAE10054Black	Verstelbare buitenhoek	Angle extérieur flexible	6
IWAI10054B	Verstelbare binnenhoek	Angle intérieur flexible	6
IWAI10054Black	Verstelbare binnenhoek	Angle intérieur flexible	6
IWAP10054B	Vlakke hoek	Angle plat	8
IWAP10054Black	Vlakke hoek	Angle plat	8
IWGT10054B	T-stuk	Déviation-T	6
IWGT10054Black	T-stuk	Déviation-T	6
IWGUB100	Verbinding voor basis en deksel	Joint pour base et couvercle	100
IWGUB100Black	Verbinding voor basis en deksel	Joint pour base et couvercle	100
IWS10040B	Scheidings:	Séparateur	8
IWS10040Black	Scheidings:	Séparateur	8
IWTT10054B	Eindstuk	Embout	12
IWTT10054Black	Eindstuk	Embout	12



CEE STEKKERS - IP67 PRISES CEE - IP67

Stekkers

Fiches mâles



BESTELNUMMER N° DE COMMANDE	Stroomsterk Ampérage	POLEN PÔLES	SPANNING TENSION	
679316-4	16 A	3	250 V	10
679416-4	16 A	4	415 V	10
679516-4	16 A	5	415 V	10
679332-4	32 A	3	250 V	10
679432-4	32 A	4	415 V	10
679532-4	32 A	5	415 V	10
679363-8	63 A	3	250 V	1
679463-8	63 A	4	415 V	1
679563-8	63 A	5	415 V	1

IP67



Koppelstekkers

Fiches femelles



BESTELNUMMER N° DE COMMANDE	Stroomsterk Ampérage	POLEN PÔLES	SPANNING TENSION	
679316-3	16 A	3	250 V	10
679416-3	16 A	4	415 V	10
679516-3	16 A	5	415 V	10
679332-3	32 A	3	250 V	10
679432-3	32 A	4	415 V	10
679532-3	32 A	5	415 V	10
679363-7	63 A	3	250 V	1
679463-7	63 A	4	415 V	1
679563-7	63 A	5	415 V	1

IP67



CEE STEKKERS - IP67 PRISES CEE - IP67

Wanddozen

Prises murales



BESTELNUMMER N° DE COMMANDE	Stroomsterk Ampérage	POLEN PÔLES	SPANNING TENSION	
679316-2	16 A	3	250 V	10
679416-2	16 A	4	415 V	10
679516-2	16 A	5	415 V	10
679332-2	32 A	3	250 V	10
679432-2	32 A	4	415 V	10
679532-2	32 A	5	415 V	10
679363-6	63 A	3	250 V	1
679463-6	63 A	4	415 V	1
679563-6	63 A	5	415 V	1

IP67



Inbouwdozen

Prises à encastrer



BESTELNUMMER N° DE COMMANDE	Stroomsterk Ampérage	POLEN PÔLES	SPANNING TENSION	
679316-1	16 A	3	250 V	10
679416-1	16 A	4	415 V	10
679516-1	16 A	5	415 V	10
679332-1	32 A	3	250 V	10
679432-1	32 A	4	415 V	10
679532-1	32 A	5	415 V	8
679363-5	63 A	3	250 V	2
679463-5	63 A	4	415 V	2
679563-5	63 A	5	415 V	2

IP67

5polen/poles = 3polen/poles + T + N

4polen/poles = 3polen/poles + T

3polen/poles = 2polen/poles + T



Fitting in thermoplast E27

Soquet thermoplastique E27



Kelderverlichtingen

Hublots



BESTELNUMMER N° DE COMMANDE	KLEUR	COULEUR	
755	Zwart	Noir	50 / 500



BESTELNUMMER N° DE COMMANDE	Specificiteit Spécificités	VERMOGEN PUISSANCE	
460	1	100 W	1/30
470	2	100 W	1/18
471	3	60 W	1/24

Voet : PVC

Glas : Polycarbonaat / onbreekbaar.

Pied : PVC

Verre : Polycarbonate / incassable



Brandwerende E90 Anti Feu E90

Brandwerende dozen E90 connectors incl.

Boîtes Anti Feu E90 connecteurs incl.



BESTELNUMMER N° DE COMMANDE	Ingange/ Entrées	∅	AFMETING DIMENSIE	VERPAK- EMBAL.
J100BF	7*	M25	102x102	1
J100SF	6+1*	M20+M2	102x102	1
J160BF	10	M25	166x116	1
J200BF	10	M32	216x166	1

*Schroefingangen

*Entrées filetées

IP66 - Volgens - Selon DIN 4102-12 - Kema EN 60670-22

Keramische connector in steatiet inclusief

Connecteur ceramique en stéatite inclus



Wartel E90

Presse-étoupe E90



BESTELNUMMER N° DE COMMANDE	Normes	AFMETING DIMENSIE	VERPAK- EMBAL.
BM20LA	IP68	20 mm	50
BM25LA	IP68	25 mm	20



Keramische connector in steatiet

Connecteur ceramique en stéatite



BESTELNUMMER N° DE COMMANDE	Normes	∅	AFMETING DIMENSIE	VERPAK- EMBAL.
J402Z	VDE	1,5-6mm	20X18X mm	1
J1602	VDE	1,5-10mm	25x23x2 mm	1
J2021	VDE	1,5-16mm	33x30x2 mm	1

Voor stijve en flexibele draad / Pour fil rigide et flexible
VDE gekeurd - certifiés VDE



FUNCTIEBEHOUD MAINTIEN DE FONCTION

FBB beugel, inclusief schroefanker - E90

Attache, cheville à visser incluse - E90

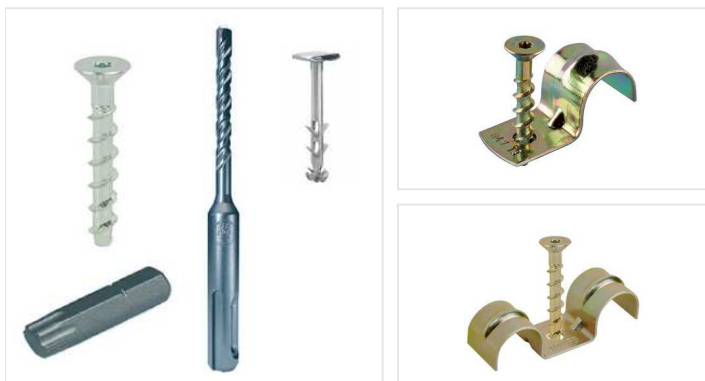

BESTELNUMMER N° DE COMMANDE	∅	VERPAK. EMBAL.
9700806	6 mm	200 / 800
9700808	8 mm	200 / 800
9700810	10 mm	200 / 800
9700812	12 mm	200 / 800
9700814	14 mm	150 / 600
9700816	16 mm	150 / 600
9700819	19 mm	150 / 600
9700825	25 mm	100 / 400
9702816	16 mm	75/300
9702819	19 mm	75/300
9700850	*1	
9700855	*2	
9700860	*3	
9230460	*4	

Per verpakking een SDS boor (torx bitje) inclusief

*1 Schroefanker - TSM

*2 Schroefbit - Torx 25 - 1/4"

*3 SDS functiebehoudboor - dia. 5x110

*4 Duimnagel E30 - E90 - E120

Une mèche SDS (torx) incluse par emballage

*1 Vis maintien de fonction - TSM

*2 nr 25 Embout de vissage - Torx 25 - 1/4"

*3 Mèche SDS - dia. 5x110

*4 Cheville à Pousser E30 - E90 - E120



FBB beugel, inclusief inslaganker - E90

Attache, cheville à frapper incluse - E90

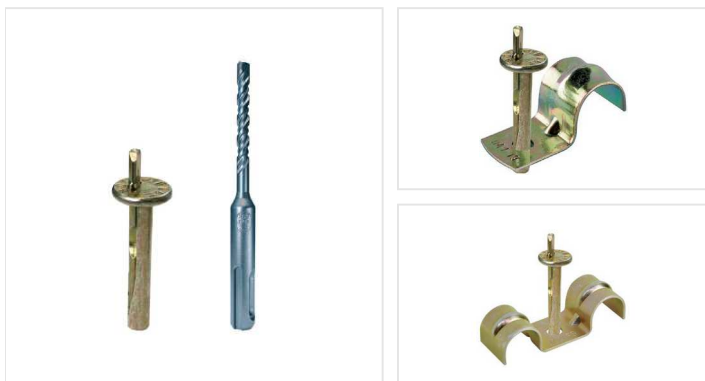

BESTELNUMMER N° DE COMMANDE	∅	VERPAK. EMBAL.
9700826	6 mm	200 / 800
9700828	8 mm	200 / 800
9700830	10 mm	200 / 800
9700832	12 mm	200 / 800

*1 SDS functiebehoudboor - dia. 6x110

*2 Inslaganker TDN 6/35

*1 Mèche SDS - dia. 6x110

*2 Cheville à frapper maintien de fonction TDN 6/35



FUNCTIEBEHOUD MAINTIEN DE FONCTION

FBB beugel, inclusief inslaganker - E90

Attache, cheville à frapper incluse - E90



BESTELNUMMER N° DE COMMANDE	∅	VERPAK. EMBAL.
9700834	14 mm	150 / 600
9700836	16 mm	150 / 600
9700839	19 mm	150 / 600
9700845	25 mm	100 / 400
9702836	16 mm	75/300
9702839	19 mm	75/300
9700880	*2	
9700875	*1	

*1 SDS functiebehoudboor - dia. 6x110

*2 Inslaganker TDN 6/35

*1 Mèche SDS - dia. 6x110

*2 Cheville à frapper maintien de fonction TDN 6/35



FBB Beugel en Duim Nagel

Attache + cheville à pousser maintien de fonction



BESTELNUMMER N° DE COMMANDE	OMSCH	DESCRI	∅	VERPAK. EMBAL.
9700817	Enkel	Simple	16 mm	150/ 600
9700820	Enkel	Simple	19 mm	150/ 600
9702817	Dubbel	Double	16 mm	150/ 600
9702820	Dubbel	Double	19 mm	150/ 600



Schroefanker met Plug met draad M10/M8

Vis à béton et cheville avec filetage interne M10/M8



BESTELNUMMER N° DE COMMANDE	VERPAK. EMBAL.
9401052	50



FUNCTIEBEHOUD MAINTIEN DE FONCTION

Klem voor buis en kabel met eenzijdige schuifbare sluiting

Collier pour câble et tube-fermeture unilatérale coulisse



BESTELNUMMER N° DE COMMANDE	∅	VERPAK. EMBAL.
5605-16	14-18 mm	100/1300
5605-22	19-23 mm	75/1200
5605-28	24-28 mm	50/1000
5605-38	30-38 mm	40/640
5605-50	39-52 mm	30/360
5605-60	53-61 mm	20/200

E60 (volgens/selon DIN 4102-12)

Ook / aussi : INOX



Verzamelbeugel Cable guide Functiebehoudbevestiging

Collier pour câbles à maintient de fonction



BESTELNUMMER N° DE COMMANDE	AFMENTINGEN DIMENSIONS	VERPAK. EMBAL.
9702845	74x73 mm	1/36

E30-E90



Inslaganker met kraag

Douilles de frappe avec colerette



BESTELNUMMER N° DE COMMANDE	AFMENTINGEN DIMENSIONS	VERPAK. EMBAL.
2014	M8	100
2016	M10	100
2012	M10	100



FUNCTIEBEHOUD MAINTIEN DE FONCTION

Slaganker met plug met draad M8/M10

Cheville à frapper et cheville avec filetage interne M10/M8



BESTELNUMMER N° DE COMMANDE	VERPAK. EMBAL.
9401051	100



Schroefanker met Plug met draad M10/M8

Vis à béton et cheville avec filetage interne M10/M8



BESTELNUMMER N° DE COMMANDE	VERPAK. EMBAL.
9401052	50



Inslaganker met kraag

Douilles de frappe avec colerette

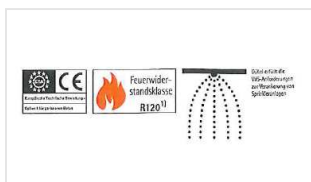

BESTELNUMMER N° DE COMMANDE	AFMENTINGEN DIMENSIONS	VERPAK. EMBAL.
2014	M8	100
2016	M10	100
2012	M10	100



Keilbout

Boulon expansible

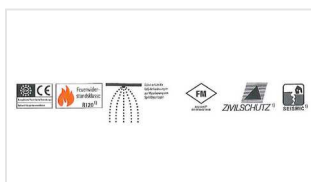

BESTELNUMMER N° DE COMMANDE	AFMENTIN DIMENSIO	RAL	VERPAK. EMBAL.
4570	M8 x32		100



FUNCTIEBEHOUD MAINTIEN DE FONCTION

Brandwerend Schroefanker - MMS Plus

Vis à maintient de fonction - MMS Plus

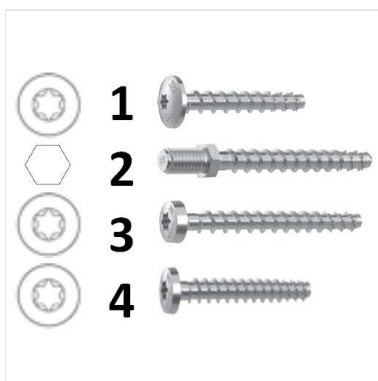

BESTELNUMMER N° DE COMMANDE	Specificiteit Spécificités	AFMENTIN DIMENSIO	VERPAK. EMBAL.
9421	1	MMS-PLUS MS 7.5X40	50
9422	2	MMS-PLUS ST 6.0X55	50
9423	3	MMS-PLUS P 6.0X50	50
9424	4	MMS-PLUS P 6.0X35	50



Ophangrail

Rail de suspension



BESTELNUMMER N° DE COMMANDE	AFMENTIN DIMENSIO	LENGTE LONGUEU	VERPAK. EMBAL.
9200900	15 x 30 mm	2m	2/20 m

Sendzimir verzinkt staal/Acier galvanisé Sendzimir
Lengte/Longueur: 2m



METALEN KANALEN CHEMINS DE CÂBLE EN METAL

Draadgoten Easy Connect - EZ

Chemins de câble Easy Connect - EZ

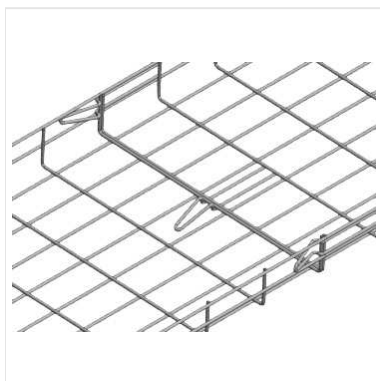

BESTELNUMMER N° DE COMMANDE	AFMENTINGEN DIMENSIONS	VERPAK. EMBAL.
EC60060EZ	60x060mm	36 / 1008 m
EC60100EZ	60x100mm	24 / 924 m
EC60150EZ	60x150mm	18 / 630 m
EC60200EZ	60x200mm	12/24/498 m
EC60300EZ	60x300mm	12 / 324 m
EC60400EZ	60x400mm	12 / 240 m
EC60500EZ	60x500mm	6 / 204 m
EC60600EZ	60x600mm	6 / 180 m

Standaard uitvoering / Finition standard
Quick Connection: met snelkoppeling / avec
connexion rapide

LIJST VAN DE TOEBEHOREN - ZIE WWW.GSV.BE
LISTE DES ACCESSOIRES - SUR WWW.GSV.BE



C - Beugel voor plafond

Fixation en C pour plafond



BESTELNUMMER N° DE COMMANDE	AFMENTINGEN DIMENSIONS	VERPAK. EMBAL.
SOPC10SG	180x115x215mm	8
SOPC15SG	180x115x265mm	8
SOPC20SG	180x115x315mm	8
SOPC30SG	180x115x415mm	8



L - beugel voor Wand

Fixation en L Murale

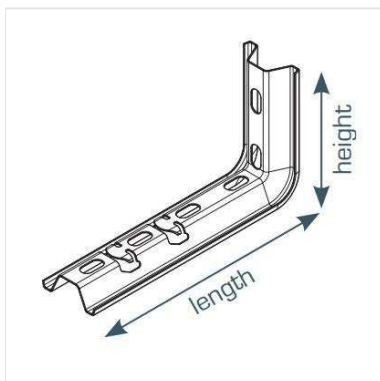

BESTELNUMMER N° DE COMMANDE	AFMENTINGEN DIMENSIONS	VERPAK. EMBAL.
SOC10SG	115x215mm	10
SOC15SG	115x265mm	10
SOC20SG	115x315mm	10
SOC30SG	115x415mm	10



METALEN KANALEN CHEMINS DE CÂBLE EN METAL

Snel Verbinder

Connecteur Rapide

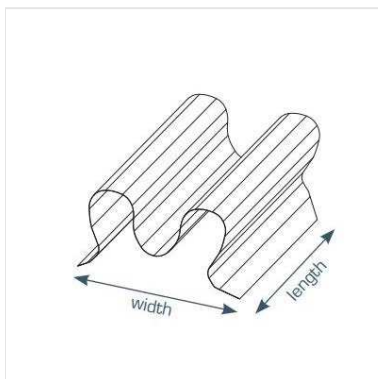

BESTELNUMMER N° DE COMMANDE	AFMENTINGEN DIMENSIONS	VERPAK. EMBAL.
MCLIC390SZ	13x23mm	100

Index Produit

0		3		6		7	
031G	39	3004-18	43	601620	45	745-LAN	21
031T	39	3005-18	43	601922	45	755	64
1		3006-18	43	602125	45	9	
108	38	300620W	44	611620	45	905	40
2		3007-18	43	611922	45	90507	28
2012	68, 69	3007-18Black	26, 43	612125	45	90509	28
2014	68, 69	300720W	44	679316-1	63	90511	28
2016	68, 69	3008-20	43	679316-2	63	90513	28
2035	38	3009-20	43	679316-3	62	90516	28
2036	38	3010-35	43	679316-4	62	90521	28
2036 Black	25	3011-35	43	679332-1	63	90529	28
2036D	39	3012-35	43	679332-2	63	90536	28
2037	38	3014-40	43	679332-3	62	90548	28
2037 Black	25	3016-40	43	679332-4	62	905M12-DMRL01	30
2037D	39	3018-40	43	679363-5	63	905M16-DMRL03	30
2038	38	3020-40	43	679363-6	63	905M20-DMRL04	30
2039	38	316	15	679363-7	62	905M25-DMRL06	30
204	38	318	15	679363-8	62	906	41
204 Black	25	36.81	18	679416-1	63	90607	29
204 White	25	397-3A	23	679416-2	63	90609	29
20436	35	397-5	23	679416-3	62	90611	29
2047	41	398-5	23	679416-4	62	90613	29
2048	41	399-5	23	679432-1	63	90616	29
204D	39	4		679432-2	63	906-2	41
2050	42	411620	45	679432-3	62	90621	29
2051	42	424	14	679432-4	62	90629	29
208	38	426	14	679463-5	63	90636	29
208 Black	25	428	14	679463-6	63	90648	29
209	38	429	14	679463-7	62	907	41
210	38	430	14	679463-8	62	90707	29
211	38	430V	14	679516-1	63	90709	29
211D	39	431	14	679516-2	63	90711	29
219B	8	431V	14	679516-3	62	90713	29
220A	7	4570	69	679516-4	62	90716	29
220AM	7	460	64	679532-1	63	90721	29
220B	8	470	64	679532-2	63	90729	29
222A	7	471	64	679532-3	62	90736	29
222AM	7	5		679532-4	62	90748	29
222B	8	50704	22	679563-5	63	907M12	32
223A	7	50706	22	679563-6	63	907M16	32
223AM	7	50710	22	679563-7	62	907M20	32
223ATA	7	50716	22	679563-8	62	907M20 Black	24
223ATAM	7	50725	22	7		907M25	32
223B	8	512	40	700-02	43	907M32	32
223BTA	8	512-2	40	700-05	43	907M40	32
223LTATR	10	513	40	700-08	43	907M50	32
224A	7	513-2	40	700-08 Black	43	907M63	32
224AM	7	514	40	700-11	43	908	41
224B	8	515	40	700-16	43	908M16	32
224LTR	10	515-2	40	700-23	43	908M20	32
226B	8	516	40	701516	42	908M25	33
242MF	10	516-2	40	701920	42	908M32	33
250-11AM	19	517	40	702-0	44	908M40	33
250-5AM	19	517-2	40	702-1	44	908M50	33
250-9AM	19	518	40	702-2	44	909M16	33
250-9B	19	518-2	40	702225	42	909M20	33
273MF	19	519	40	702-2W	26	9200900	70
28.41	12	520	40	702-3	44	9230460	66
28.43	12	5605-16	68	703235	42	9401051	69
28.43-PLEXI	12	5605-22	68	710-15	41	9401052	67, 69
28.51	12	5605-28	68	710-30	41	9421	70
28.53	13	5605-38	68	745-4C LG	21	9422	70
28.61	12	5605-50	68	745-8C LG	21	9423	70
		5605-60	68	745-CRF748	21	9424	70

Index Produit

9		C		H		I
9700806	66	C500	19	HF	3, 4, 5, 6,	IWS10040B
9700808	66	C50VD	5		7, 8, 9,	IWS10040Black
9700810	66	C50VD R	5		10, 11,	IWTT10054B
9700812	66	CFR748	21		12, 13,	IWTT10054Black ..
9700814	66	CLT102110R	51		14, 15,	IWTT2012B
9700816	66	CLT102116R	51		16, 17,	IWTT2012Black
9700817	67	CLT102129R	51		18, 19,	IWTT4017B
9700819	66	CLT102149R	52		20, 21,	IWTT4017Black
9700820	67				22, 23,	
9700825	66	E			24, 25,	
9700826	66	E120	68, 69,		26, 27,	J
9700828	66		70		28, 29,	J100B
9700830	66	E60	68		30, 31,	J100BF
9700832	66	E90	14, 65,		32, 33,	J100L
9700834	67		66, 67,		34, 35,	J100S
9700836	67		68, 69,		36, 37,	J100S Black
9700839	67	EC16	70, 71		38, 39,	J100S White
9700845	67	EC16 R	6		40, 41,	J100SC
9700850	66	EC20	6		42, 43,	J100SF
9700855	66	EC20 Black	24		44, 45,	J1602
9700860	66	EC20 R	6		47, 48,	J160B
9700875	67	EC20 White	24		49, 50,	J160BF
9700880	67	EC25	6		51, 52,	J160L
9702816	66	EC25 R	6		53, 54,	J200B
9702817	67	EC60060EZ	71		55, 56,	J200BF
9702819	66	EC60100EZ	71		57, 58,	J200L
9702820	67	EC60150EZ	71		59, 60,	J2021
9702836	67	EC60200EZ	71		61, 62,	J402Z
9702839	67	EC60300EZ	71		63, 64,	J80B
9702845	68	EC60400EZ	71		65	J80L
9707-ORL01	28	EC60500EZ	71	I		K
9709-ORL02	28	EC60600EZ	71	IW10054BLH	60	KPZ1PO
9711-ORL03	28	ECICTA20HF	4	IW10054LHBLACK ..	60	L
9713-ORL04	28	ECICTA20HFT	4	IW2012.5BLH	55	LHD2010HF
9716-ORL05	28	ECICTA25HF	4	IW2012.5LHBlack ..	56	LHD2020HF
9721-ORL06	28	ECICTA25HFT	4	IW2020LH	55	LHD4020HF
9729-ORL07	28	ERFE20G	4	IW4017LH	55	LHD4040HF
9736-ORL08	28	ERFE25G	4	IW4017LHBlack	56	LHD8623HF
9748-ORL10	28			IW4040BLH	55	LHD8624HF
B		F		IW6040LH	55	LHD8625HF
BM12	30	FE12	11	IWAE10054B	61	LHD8626HF
BM16	30	FE15	11	IWAE10054Black ..	61	LHD8633HF
BM20	30	FE25	11	IWAE2012B	56	LHD8634HF
BM20 Black	26	FE25 Black	27	IWAE4017B	56	LHD8635HF
BM20 White	26	FE25 White	27	IWAE4017Black	57	LHD8636HF
BM20LA	65	FE7	11	IWAI10054B	61	LHD8643HF
BM25	30	FE7 Black	27	IWAI10054Black ...	61	LHD8644HF
BM25LA	65			IWAI2012B	56	LHD8645HF
BM32	30			IWAI2012Black	57	LHD8646HF
BM40	30			IWAI4017B	56	LHD8923HF
BM50	30			IWAI4017Black	57	LHD8924HF
BM63	30			IWAE10054B	61	LHD8925HF
C				IWAE2012Black	57	LHD8926HF
C16VD	5			IWAE4017B	56	LOCKCM
C16VD R	5			IWAE4017Black	57	LOCKDM
C20VD	5			IWAE4017Black	57	M
C20VD R	5			IWAI10054B	61	M001CS
C25VD	5			IWAI10054Black ...	61	M002CS
C25VD R	5			IWAI2012B	56	M003CS
C25VDLHBLACK ..	5			IWAI2012Black	57	M005CS
C32VD	5			IWAI4017B	56	MCLIC390SZ
C32VD R	5			IWAI4017Black	57	ME1216
C40VD	5			IWAE10054B	61	ME1620
C40VD R	5			IWAE2012Black	57	ME2025
				IWAE4017B	56	ME2532
				IWAE4017Black	57	ME3240
				IWAI10054B	61	
				IWAI10054Black ...	61	
				IWAI2012B	56	
				IWAI2012Black	57	
				IWAI4017B	56	
				IWAI4017Black	57	
				IWAP10054B	61	
				IWAP10054Black ..	61	
				IWAP2012B	56	
				IWAP2012Black	57	
				IWAP4017B	56	
				IWAP4017Black	57	
				IWGT10054B	61	
				IWGT10054Black ..	61	
				IWGT2012B	56	
				IWGT2012Black ...	57	
				IWGT4017B	56	
				IWGT4017Black ...	57	
				IWGU2012B	56	
				IWGU2012Black ...	57	
				IWGU4017B	56	
				IWGU4017Black ...	57	
				IWGUB100	61	
				IWGUB100Black ...	61	

Index Produit

M

MET22102R	51
MET22105R	51
MET22110R	51
MET22111R	51
MET22112R	51
MET22123R	51
MET22126R	51
MET22140R	51
MET22534R	51
MET32102R	51
MET32105R	51
MET32110R	51
MET32111R	51
MET32112R	51
MET32123R	51
MET32126R	51
MET32140R	51
MET32326R	51
MET32534R	51
MF111	52
MIB16	9
MIB21	9
MIB29	9
MIBR1620	6
MIBR1620 Black	24
MIBR1620 White	24
MR1612	34
MR2012	34
MR2016	34
MR2512	34
MR2516	34
MR2520	34
MR3212	34
MR3216	34
MR3220	34
MR3225	34
MR4016	34
MR4020	34
MR4025	34
MR4032	34
MR5020	34
MR5025	34
MR5032	34
MR5040	34
MR6325	34
MR6332	34
MR6340	34
MR6350	34

N

N12-C	16
N12-D	17
N18-C	16
N18-D	17
N24-C	16
N24-D	17
N2x18-C	16
N36-C	16
N36-D	17
N3x18-C	16
N48-C	16
N48-D	17
N4-C	16
N4-D	17
N4x18-C	16

N

N6-D	17
N8-C	16
N8-D	17
NEW	35, 36,
	37
NSET-C-D	18
NVIS-C-D	17

O

OL70211	44
OL70212	44
OL70213	44
OL70214	44
OL70215	44
OL70216	44
OL70217	44
OL70218	44
OMRL03 M16	31
OMRL05 M20	31
OMRL05A7	30
OMRL09 M50	31
OMRL10 M63	31
OMSL01	31
OMSL02	31
OMSL03	32
OMSL04	32
OMSL05	32
OMSL06	32
OMSL07	32
OMSL08	32

P

PM12	31
PM16	31
PM20	31
PM25	31
PM32	31
PM40	31
PM50	31
PM63	31
PST-5	36
PST-7	36
PSTB-4	36
PSTB-7	36

R

RH18S	18
RH36/2S	18
RH54/3S	18
RH72/4S	18

S

SAI160BEU	58
SDK3	22
SDK5	22
SDK8	22
SDKF2TR-AN	22
SDKF3TR-AN	22
SDKF5TR-AN	22
SEL.2.202T	50
SEL101	52
SEL10202R	49
SEL10210R	49
SEL10223R	49
SEL10425R	49
SEL11202R	49
SEL11210R	49
SEL11223R	49
SEL11425R	50

S

SEL12202R	50
SEL12210R	50
SEL12223R	50
SEL12425R	50
SEL14202R	50
SEL14210R	50
SEL14223R	50
SEL14425R	50
SEL2142	49
SEL2143	49
SEL2144	49
SEL2155	49
SEL2201	48
SEL2202	48
SEL2203	48
SEL2204	48
SEL2205	48
SEL2210	48
SEL2211	48
SEL2212	48
SEL2214	48
SEL2216	48
SEL2220	48
SEL2221	48
SEL2222	48
SEL2223	48
SEL2224	48
SEL2401	53
SEL2402	53
SEL2403	53
SEL2425	48
SEL2426	48
SEL2427	48
SEL2428	48
SEL2429	48
SEL2430	48
SEL2431	49
SEL2432	49
SEL2433	49
SEL2434	49
SEL2435	47, 49
SEL2436	49
SEL2438	49
SEL2441	49
SEL2447	48
SEL2450	49
SEL2451	49
SEL2452	49
SEL2453	49
SEL2501	52
SEL2502	52
SEL3142	47
SEL3143	47
SEL3144	47
SEL3150	48
SEL3155	47
SEL3201	47
SEL3202	47
SEL3203	47
SEL3204	47
SEL3205	47
SEL3210	47
SEL3211	47
SEL3212	47

S

SEL3214	47
SEL3215	48
SEL3216	47
SEL3220	47
SEL3221	47
SEL3222	47
SEL3223	47
SEL3224	47
SEL3320	50
SEL3321	50
SEL3322	50
SEL3323	50
SEL3324	50
SEL3425	47
SEL3426	47
SEL3427	47
SEL3428	47
SEL3429	47
SEL3430	47
SEL3431	47
SEL3432	47
SEL3433	47
SEL3434	47
SEL3436	47
SEL3437	49
SEL3438	47
SEL3441	47
SEL3447	47
SEL3451	48
SEL3452	48
SEL3453	48
SEL712006	45
SEL712008	45
SEL712010	45
SEL712012	45
SELCGO101	46
SELCPX102	46
SELCPX104	46
SELCPX106	46
SELPXV101	46
SELRXO101	46
SELRXO102	46
SOC10SG	71
SOC15SG	71
SOC20SG	71
SOC30SG	71
SOPC10SG	71
SOPC15SG	71
SOPC20SG	71
SOPC30SG	71
ST16	35
ST20	35
ST25	35
ST32	35
ST40	35
ST-BASE	37
STC16	35
STC20	35
STC25	35
STC32	35
STC40	35
ST-CLIP	36

T

TPQSM32	20
---------	----

Index Produit

U

U12-C	16
U18-C	16
U24-C	16
U2x18-C	16
U36-C	16
U3x18-C	16
U407	5
U407 R	5
U408	5
U408 Black	25
U408 R	5
U408 White	25
U409	5
U409 Black	25
U409 R	5
U410	5
U410 R	5
U411	5
U411 R	5
U412	5
U412 R	5
U413R	5
U4-C	16
U8-C	16

V

V6H100100	54
V6H10060	54
V6H10080	54
V6H2525	54
V6H4025	54
V6H4040	54
V6H4060	54
V6H4080	54
V6H60100	54
V6H60120	54
V6H6025	54
V6H6040	54
V6H6060	54
V6H6080	54
V6H80100	54
V6H80120	54
V6H8025	54
V6H8040	54
V6H8060	54
V6H8080	54
VD16 FLH	3
VD16 LLH	3
VD16 MLH	3
VD20 FLH	3
VD20 LLH	3
VD20 LLHBLACK ..	3
VD20 MLH	3
VD20HFPPMOF ...	4
VD25 LH	3
VD25 LLH	3
VD25 LLHBLACK ..	3
VD25HPPPMOF ...	4
VD32 LH	3
VD32 LLH	3
VD40 LH	3
VD50 LH	3
VD63 LH	4

WWW.GSV.BE

09/2023



#GSV-WEB



#GSV

TERBEKEHOFDREEF 51
2610 WILRIJK

T: +32 3 326 50 77

F: +32 3 326 49 23

WWW.GSV.BE
E: office@gsv.be

BTW/TVA BE 0427.142.369
HRA/RCA 245.824



SINDS | DEPUIS 1985
WIJ BEVESTIGEN UW TOEKOMST
UNE ATTACHE POUR VOTRE AVENIR