

BEVESTIGINGSMATERIAAL MATERIEL DE FIXATION

CATALOGUS
CATALOGUE

2023
02

The logo for G2V, featuring the letters 'G2V' in a bold, black, sans-serif font. The '2' is stylized with a horizontal line through it. To the right of the letters is a graphic element consisting of three overlapping, curved shapes in shades of orange and yellow, resembling a stylized flame or a leaf.

SINDS – DEPUIS 1985

WIJ BEVESTIGEN UW TOEKOMST

UNE ATTACHE POUR VOTRE AVENIR

GEL/HARS GEL/RESINE

ALL IN ONE GEL – Twee componenten

ALL IN ONE GEL – Bi composant



BESTELNUMMER N° DE COMMANDE	Normes	INHOUD CONTENU	Spanning Tension	
MP103	-60 +200°C	300ml	25,5 kV/mm	1/12
MP106	-60 +200°C	600 ml	25,5 kV/mm	1/12
MP109	-60 +200°C	900 ml	25,5 kV/mm	1/12

-60 +200°C
25,5 kV/mm



ALL IN ONE GEL - Display

ALL IN ONE GEL - Display



Beschikbaar

Disponible

GEL - Twee componenten

GEL - Bi composant



BESTELNUMMER N° DE COMMANDE	INHOUD CONTENU
MP0100	1 L (2 X 0,5 L.)
MP0030	300 ml
MP2200	2 L
MP1000	10 L

GEL/HARS GEL/RESINE

GEL - Eén component - Cartridge
 GEL - Mono composant - Cartouche



BESTELNUMMER N° DE COMMANDE	INHOUD CONTENU
MPONE GEL	300 ml (Injecteerbaar / Injectable)

Polyurethaan hars - Twee componenten
 Résine polyuréthane - Bi composant



BESTELNUMMER N° DE COMMANDE	INHOUD CONTENU
RS150	0,110 L
RS300	0,220 L
RS400	0,290 L
RS550	0,400 l
RS650	0,470 L
RS1650	1,200 L

Met veiligheids vulsysteem
 Avec système de remplissage sécurisé

SHARK - Rechte koppelingen gevuld met gel - met connector
 SHARK - Joints pré-remplis en gel - avec connexion



BESTELNUMMER N° DE COMMANDE	∅	Afm. Dim.	Polen Poles
SHARK150	*	86x47 mm	1
SHARK325	1,5 - 2,5 mm ²	86x47 mm	3
SHARK306	1,5 - 6 mm ²	145x50 mm	3
SHARK516	6 - 16 mm ²	180x69 mm	5
SHARK506	1,5 - 6 mm ²	146x50 mm	5

*6 à 25 mm² : voor harde draad
 ≤ 35mm² : voor flexibele draad
 *6 à 25 mm² : pour câble rigide
 ≤ 35mm² : pour câble souple

GEL/HARS GEL/RESINE

Y Koppeling gevuld met Gel Met Connector
 Joint en Y pré-rempli en Gel avec Connexion



BESTELNUMMER N° DE COMMANDE	∅	Afm. Dim.	Polen Poles
SHARK516Y	6 - 16 mm ²	220 x 110 mm	5

*6 - 16 mm²

SHARK - Rechte koppelingen gevuld met gel
 SHARK - Joints pré-remplis en gel



BESTELNUMMER N° DE COMMANDE	∅	Afm. Dim.	Polen Poles
SHARK506WS	6 - 16 mm ²	180x69 mm	5
SHARK525WS	6 - 25 mm ²	240x75 mm	5

Met connector & trekcontlasting

SHARK68 - Rechte koppelingen IP68
 SHARK68 - Joints IP68



BESTELNUMMER N° DE COMMANDE	∅	Polen Poles
SHARK6801A	6 - 50 mm ²	1
SHARK6801B	1,5 - 6 mm ²	3
SHARK6801C	1,5 - 6 mm ²	3
SHARK6801D	2,5 - 6 mm ²	4
SHARK6802A	2,5 - 10 mm ²	5
SHARK6803A	10 - 25 mm ²	5

IP 68



GEL/HARS GEL/RESINE

Koppeling gevuld met Gel - IP68 - Voor Tuinspot
 Jonction IP68 pré-remplie de Gel pour Spot Led encastrable



BESTELNUMMER N° DE COMMANDE	∅	Afm. Dim.	
LDJ01	0,5 - 1,5 mm ²	118x25 mm	1

IP68, 450V, 24A; EN60529



Met gel gevulde Mini Box
 pré-rempli de gel Mini Box



BESTELNUMMER N° DE COMMANDE	∅	Afm. Dim.	
MJB112	0,2 - 4 mm ²	33x26x2 mm	2/12
MJB113	0,2 - 4 mm ²	33x26x2 mm	2/12
MJB215	0,2 - 4 mm ²	33x34x23 mm	1/12
MJB222	0,2 - 4 mm ²	33x34x23 mm	1/12
MJB332	0,2 - 4 mm ²	33x46x23 mm	1/12

IPX8, CE, EN 60947-7-1, EN 60998-2-2, 600V, 32A

EVO - Rechte koppelingen gevuld met gel
 EVO - Joints pré-remplis en gel droit



BESTELNUMMER N° DE COMMANDE	∅ IN	FASES PHASES	∅	Afm. Dim.	Spanning Tension
EV100	0,5-1,5 mm ²	2P	4,5-6,5 mm	68 × 24 × 22 mm	450 V
EV101	0,75-2,5 mm ²	3P	6-8 mm	72 × 28 × 24 mm	450 V
EV102	1,5-2,5 mm ²	3P	10-13 mm	80 × 35 × 28 mm	0,6/1 kV
EV103	1,5-6 mm ²	5P	13-17 mm	145 × 56 × 35 mm	0,6/1 kV
EV104	2,5-6 mm ²	5P	14-22 mm	183 × 70 × 42 mm	0,6/1 kV
EV105	4-16 mm ²	5P	14-22 mm	183 × 70 × 42 mm	0,6/1 kV

24A

GEL/HARS GEL/RESINE

EVO - T-vorm koppelingen gevuld met gel

EVO - Joints pré-remplis en gel en T



BESTELNUMMER N° DE COMMANDE	∅ IN	FASES PHASES	∅	Afm. Dim.	Spanning Tension
EV201D	1-2,5 / 1-1,25 mm ²	3P	6-8 mm	73 x 73 x 23 mm	450 V
EV202D	1,5-4 / 1-1,25 mm ²	3P	10-13 / 6-8 mm	105 x 90 x 28 mm	0,6/1 kV 300/500 V
EV203D	1,5-4 mm ²	3P	10-13 mm	105 x 90 x 28 mm	0,6/1 kV

24A

IP BOX

IP BOX



BESTELNUMMER N° DE COMMANDE	Afm. Dim.	INHOUD CONTENU	
MF1604	80 x 80 x 40mm	270ml	1

Ondergrondse aftakdoos. Een gemakkelijke en snelle kit.
Kit bevat: - 1 x aftakdoos - 3 x Wartel - 1 x Schuurpapier
- 1 x Hars - 3 x Steekklem - 1 x Handschoen

Boîte de dérivation souterraine. Un kit facile et rapide. Kit
contient: - 1 x Boîte de dérivation - 3 x Presse-étoupe - 1 x
Papier abrasif - 1 x Résine à mouler - 3 x Raccord rapide - 1 x
Gants de protection

IP68 ; EN 60670-1:2005 ; EN 60670-22:2006 ; IEC
60455-3-8:2013



BESCHERMING EN VEILIGHEID PROTECTION ET SECURITE

OPTISCHE MINI ROOKMELDER
DÉTECTEUR DE FUMÉE OPTIQUE MINI



BESTELNUMMER
N° DE COMMANDE



MF003

1

DÉTECTEUR DE FUMÉE PHOTOELECTRIQUE MINIATURISE
MINI OPTISCHE ROOKMELDER
Autonomie/Levensduur van 10 ans/Jaar
Bouton test /Testknop

WINTER HIVER

Vorstwerend Snoer
Cable anti-gel



BESTELNUMMER N° DE COMMANDE	∅	Afm. Dim.	
EASY02	0,2 - 4 mm ²	2 m	1
EASY04	0,2 - 4 mm ²	4 m	1
EASY08	0,2 - 4 mm ²	6 m	1
EASY12	0,2 - 4 mm ²	12 m	1
EASY18	0,2 - 4 mm ²	18 m	1

Incl. Thermost. IPX7, 230V

ZELFREGULERENDE VERWARMINGSKABEL
CÂBLE CHAUFFANT AUTO REGULANT



BESTELNUMMER N° DE COMMANDE	Specificiteit Spécificité	∅	Afm. Dim.	Spanning Tension	
HTC18S	-20°C > +10°C	0,55 mm ²	8 × 5 mm	230 V AC	1

NIEUW
NOUVEAU
REF.

ISOLERENDE BUIS UITLAAT KIT
KIT POUR SORTIE TUBE ISOLANT

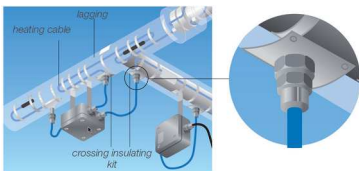

BESTELNUMMER N° DE COMMANDE	Specificiteit Spécificités	
KCP00S	Series S	1

NIEUW
NOUVEAU
REF.

KIT CONNECTIE EN EINDSTUK
KIT CONNECTION ET EMBOUT

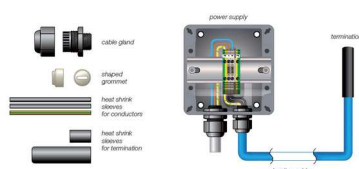

BESTELNUMMER N° DE COMMANDE	Specificiteit Spécificités	
KTA00S	Series S	1

NIEUW
NOUVEAU
REF.

PVC - LSOH PVC - LSOH

Kabeldozen met uitbrekbare ingangen voor wartels

Boîtes de dérivation avec entrées pré-imprimées



BESTELNUMMER N° DE COMMANDE	Ingangen Entrées	∅	Afm. Dim.	
220A	7	PG 16	80x80x50	10
220AM	7	20 mm	80x80x50	10

220A : Pg-maten / Mesures Pg

220AM : Metrische maten / Mesures métriques

IP 54 Druksluiting / Serrage à pression



Kabeldozen met uitbrekbare ingangen

Boîtes de dérivation avec entrées pré-imprimées



BESTELNUMMER N° DE COMMANDE	Ingangen Entrées	∅	Afm. Dim.	
222A	6	PG 16	100x100x55	5
223A	10	PG 16	175x110x66	2
223ATA	10	PG 16	175x110x83	2
224A	10	PG 29	220x170x120	1
222AM	6	20 mm	100x100x55	5
223AM	10	20 mm	175x110x66	2
223ATAM	10	20 mm	175x110x83	2
224AM	10	25 mm	220x170x120	1

222A à 224A : Pg-maten / Mesures Pg

222AM à 224AM : Metrische maten / Mesures métriques

Schroefsluiting / Serrage à vis 3/4"

IP 65



BOX LINE Kabeldoos met metrische schroefingangen

BOX LINE Boîte de dérivation avec filetage métrique



BESTELNUMMER N° DE COMMANDE	Ingangen Entrées	∅	Afm. Dim.	
J100S	7	M20	102²x56 mm	90
J100SC	7	M20	102²x56 mm	90

inclusief connector 3-fasen+n+t

inclus barrette 3-phases+n+t

IP 66



PVC - LSOH PVC - LSOH

BOX LINE Kabeldozen met nippel

BOX LINE Boîtes de dérivation avec entrées étanches



BESTELNUMMER N° DE COMMANDE	Ingangen Entrées	∅	Afm. Dim.	
J80B	8	M25	83x50mm	1
J100B	8	M25	102x56mm	1
J160B	8	M25	116x70mm	1
J200B	8	M32	216x166x90mm	1

IP 66



BOX LINE Kabeldozen gesloten

BOX LINE Boîtes de dérivation fermées



BESTELNUMMER N° DE COMMANDE	Ingangen Entrées	∅	Afm. Dim.	
J80L	8	M25	83 x 83 x 50 mm	1
J100L	8	M25	102 x 102 x 56mm	1
J160L	8	M25	166 x 116 x 70 mm	1
J200L	8	M32	216x166x90mm	1

IP 66



Kabeldozen met nippels

Boîtes de dérivation avec entrées étanches



BESTELNUMMER N° DE COMMANDE	Ingangen Entrées	∅	Afm. Dim.	
219B	4*	PG21	45 x ∅80 mm	8
220B	7*	20mm	80 x 80 x 50 mm	10
222B	6**	Pg21	100 x 100 x 55 mm	5
223B	10**	Pg21	175 x 110 x 66 mm	2
223BTA	10**	Pg21	175 x 110 x 83 mm	2
224B	10**	Pg29	220 x 170 x 120 mm	1
226B	10**	Pg29	220 x 170 x 120 mm	1

*Druksluiting / Serrage à pression

**Schroefsluiting 3/4" / Serrage à vis 3/4"

IP 54



Toebehoren Accessoires

Nippels
Embouts à gradin



BESTELNUMMER N° DE COMMANDE	Afm. Dim.	
MIB16	3,5-20 mm	50
MIB21	3,5-23,5 mm	50
MIB29	3,5-32 mm	50



Groot formaat Grands formats

Kabeldozen gesloten

Boîtes de dérivation fermées



BESTELNUMMER N° DE COMMANDE	Afm. Dim.	
242MF	330x280x175	1



Kabeldozen volledig gesloten met transparant deksel

Boîtes de dérivation fermées avec couvercle transparent



BESTELNUMMER N° DE COMMANDE	Afm. Dim.
223LTATR	175x110x83
224LTR	220x170x120

Schroefsluiting 3/4" / Serrage à vis 3/4"



Kabeldozen PH-4A.1

Boîtes de dérivation IP65

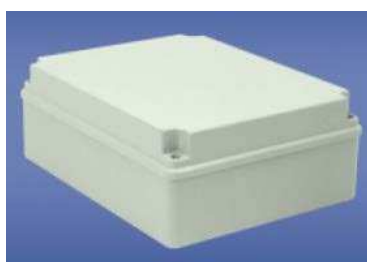



BESTELNUMMER N° DE COMMANDE	Normes	Afm. Dim.	
28.41	IP65	248x198x96	1
28.51	IP65	348x228x142	1
28.61	IP65	400x262x140	1

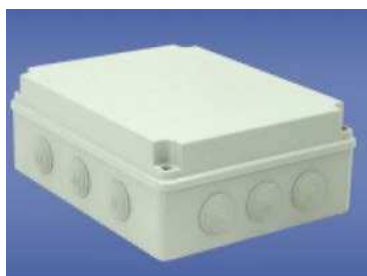

Kabeldozen met nippels PH-4A.3

Boîtes de dérivation avec entrées étanches PH-4A.3



BESTELNUMMER N° DE COMMANDE	Specificiteit Spécificités	Normes	Afm. Dim.	
28.43		IP65	248x198x96	1
28.43-PLEXI	*4		*248x198x96	1

*Met Plexi deksel - Op aanvraag

* Avec couvercle en Plexi - sur demande



Groot formaat Grands formats

Kabeldozen met nippels PH-5A.3

Boîtes de dérivation avec entrées étanches PH-5A.3



BESTELNUMMER N° DE COMMANDE	Normes	Afm. Dim.	
28.53	IP65	348x228x142	1



Vijs voor kabeldoos reeks 28

Vis pour boîtes de dérivation série 28



BESTELNUMMER N° DE COMMANDE	Afm. Dim.	
28.998	3 cm	1
28.999	5,5 cm	1



Kabeldozen serie 200

Boîtes de dérivation série 200



BESTELNUMMER N° DE COMMANDE	Afm. Dim.	
242MF	330x280x175	1
242MFTR	330x280x175	1

242MFTR met transparant deksel / avec couvercle transparent
IP65

Thermoplastisch Thermoplastique

Kabeldozen

Boîtes de dérivation



BESTELNUMMER N° DE COMMANDE	Ingangen Entrées	∅	Afm. Dim.	
FE25	10	1,5-4mm	89x43x37	10/150
FE7	7	1,5-4mm	75x75x37	10/300
FE12	12	1,5-4mm	85x85x37	10/150
FE15	12	1,5-4mm	100x100x37	10/128



Met soupele ingang Avec membrane

Ronde Kabeldoos met soupele ingang
Boîte ronde de dérivation avec membrane



BESTELNUMMER N° DE COMMANDE	Afm. Dim.	
M001CS	ø 65x40 mm	1
M002CS	ø 80x40 mm	1



Kabeldoos met soupele ingang
Boîte de dérivation avec membrane



BESTELNUMMER N° DE COMMANDE	Afm. Dim.	
M003CS	80x80x40 mm	1
M005CS	94x94x50 mm	1



Brandwerende E90 Anti Feu E90

Brandwerende dozen E90 connectors incl.
Boîtes Anti Feu E90 connecteurs incl.



BESTELNUMMER N° DE COMMANDE	Ingangen Entrées	∅	Afm. Dim.	
J100BF	7*	M25	102x102x56	1
J100SF	6+1*	M20+M25	102x102x56	1
J160BF	10	M25	166x116x70	1
J200BF	10	M32	216x166x90	1

*Schroefingangen

*Entrées filetées

IP66 - Volgens - Selon DIN 4102-12 - Kema EN 60670-22

Keramische connector in steatiet inclusief

Connecteur ceramique en stéatite inclus



Wartel E90
Presse-étoupe E90



BESTELNUMMER N° DE COMMANDE	Normes	Afm. Dim.	
BM20LA	IP68	20 mm	50
BM25LA	IP68	25 mm	20



Keramische connector in steatiet
Connecteur ceramique en stéatite



BESTELNUMMER N° DE COMMANDE	Normes	∅	Afm. Dim.	
J402Z	VDE	1,5-6mm ²	20X18X15 mm	1
J1602	VDE	1,5-10mm ²	25x23x21 mm	1
J2021	VDE	1,5-16mm ²	33x30x23 mm	1

Voor stijve en flexibele draad / Pour fil rigide et flexible
VDE gekeurd - certifiés VDE



METAL Métallique

Metalen dozen
Boîtes métalliques



BESTELNUMMER N° DE COMMANDE	Afm. Dim.	
040CDTM254	90x90x47	1
040CDTM255	110x110x51	1
040CDTM256	130x130x60	1
040CDTM257	150x150x72	1
040CDTM258	200x200x90	1

OP BESTELLING / SUR COMMANDE : INOX

SNELVERBINDERS CONNECTEURS RAPIDES

Universele steekklemmen
Raccords universels



BESTELNUMMER N° DE COMMANDE	
SDKF2TR-AN	100 / 2000
SDKF3TR-AN	75 / 1500
SDKF5TR-AN	50 / 1000



Steekklemmen voor harde draad
Raccords pour fil rigide



BESTELNUMMER N° DE COMMANDE	
SDK3	100 / 2000
SDK5	100 / 2000
SDK8	100 / 1000



Lusterklemmen
Raccords lustre



BESTELNUMMER N° DE COMMANDE	∅	
50704	2,5 - 4 mm ²	10/500
50706	6 mm ²	10/250
50710	10 mm ²	10/250
50716	16 mm ²	10/100
50725	25 mm ²	10/50

24A , 450V, CE, HF, PP
Wit / Blanc



SNELVERBINDERS CONNECTEURS RAPIDES

Klemstenen

Barrettes de connection



BESTELNUMMER N° DE COMMANDE	Specificiteit Spécificités	
397-5	*1	20
397-3A	*1	20
398-5	*2	20
399-5	*3	10

*1 Voor / Pour : 220A / 220B / 222A / 222B / 222L

*2 Voor / Pour : FE25 / FE7 / FE12

*3 Voor / Pour : BOX LINE



INBOUWDOZEN BOITES D'ENCASTREMENT

Hollewanddozen
Boîtiers pour mur creux



BESTELNUMMER N° DE COMMANDE	MOD.	∅	Afm. Dim.	
424	1	68 mm	45 mm	10/310
426	1	68 mm	61 mm	10/240
428	2	68 mm	45 mm	5/130
429	3	68 mm	45 mm	5/90



Hollewanddoos harde uitvoering - Winddicht
Boîtier rigide pour mur creux - Etanche



BESTELNUMMER N° DE COMMANDE	MOD.	Afm. Dim.	
KP64-50LD	1	68x70x50mm	110
KP64-60LD	1	68x70x60mm	84
KP64-50-2LD	2	142x70x50mm	40
KP64-50-3LD	3	213x70x50mm	30
KP64-50-4LD	4	284x70x50mm	25
KP64-50-5LD	5	351x70x50mm	14

Hollewanddoos vuurvast
Boîtier pour mur creux résistant au feu



BESTELNUMMER N° DE COMMANDE	∅	Afm. Dim.	
KPZ1PO	68 mm	47 mm	1

PP (halogen-free, pb-free) + foaming material
temperature resistance: -5 - +60 °C (activation of foaming material from 200 °C)
EN 1363-1:2013
EI 15 - EI 120



Brandwerende Hollewanddozen
Boîtiers anti-feu pour mur creux



BESTELNUMMER N° DE COMMANDE	∅	Afm. Dim.	
BS115	74 mm	54 mm	12/192
BS118	2 X 74 mm	54 mm	6/96

Op Aanvraag / Sur Commande



INBOUWDOZEN BOITES D'ENCASTREMENT

Universele inbouwdozen zonder Vijs
Boîtiers d'encastrement universel sans Vis



BESTELNUMMER N° DE COMMANDE	MOD.	Afm. Dim.	
430	1	60x60x50mm	10/200
431	1	60x60x65mm	10/200



Universele inbouwdozen met Vijs
Boîtiers d'encastrement universel avec Vis



BESTELNUMMER N° DE COMMANDE	MOD.	Afm. Dim.	
430V	1	60x60x50mm	10/200
431V	1	60x60x65mm	10/180



Inbouwdozen
Boîtiers d'encastrement



BESTELNUMMER N° DE COMMANDE	MOD.	Afm. Dim.	
316	1	75x75x42mm	10/100
318	1	75x75x60mm	10/100



VERDEELKASTEN COFFRETS DE DISTRIBUTION

Verdeelkasten opbouw Type C / IP 40 In-63A

Coffrets de distribution en saillie Type C / IP 40 In-63A



BESTELNUMMER N° DE COMMANDE	MOD.	Afm. Dim.
N4-C	1 x 4	232x139x99 mm
N8-C	1 x 8	215x236x112 mm
N12-C	1 x 12	287x236x112 mm
N18-C	1 x 18	396x236x112 mm
N24-C	2 x 12	287x361x112 mm
N36-C	3 x 12	287x485x112 mm
N2x18-C	2 x 18	396x361x112 mm
N3x18-C	3 x 18	396x526x112 mm
N48-C	4 x 12	287x651x112 mm
N4x18-C	4 x 18	651x396x112 mm

Din rail en aardingsrail inclusief en geïnstalleerd
Rail Din et barrette de terre pré-installé



Verdeelkasten inbouw Type C / IP 40 In-63A

Coffrets de distribution à encastrer Type C / IP 40 In-63A



BESTELNUMMER N° DE COMMANDE	MOD.	Afm. Dim.
U8-C	1 x 8	211x232x99 mm
U12-C	1 x 12	283x232x106 mm
U18-C	1x 18	392x232x106 mm
U24-C	2 x 12	283x357x106 mm
U36-C	3 x 12	283x482x106 mm
U2x18-C	2 x 18	392x357x106 mm
U3x18-C	3 x 18	392x522x106 mm
U4-C	1 x 4	211 x 232 x 99 mm

Din rail en aardingsrail inclusief en geïnstalleerd
Rail Din et barrette de terre pré-installé



Slot voor verdeelkasten

Serrure pour coffrets de distribution



BESTELNUMMER N° DE COMMANDE	Specificiteit Spécificités
LOCKCM	Serie C

VERDEELKASTEN COFFRETS DE DISTRIBUTION

Verdeelkasten opbouw Type D / IP 65 In-63A

Coffrets de distribution en saillie Type D / IP 65 In-63A



BESTELNUMMER N° DE COMMANDE	MOD.	Afm. Dim.
N4-D	1 x 4	127x200x120 mm
N6-D	1 x 6	165x201x120 mm
N8-D	1 x 8	200x200x120 mm
N12-D	1 x 12	318x258x142 mm
N18-D	1 x 18	
N24-D	2 x 12	318x383x142 mm
N36-D	3 x 12	318x507x142 mm
N48-D	4 X 12	

Din rail en aardingsrail inclusief en geïnstalleerd
Rail Din et barrette de terre pré-installé



Vijs voor verdeelkas
Vis pour coffret de distribution



Vijs voor serie C en D
Vis pour serie C et D



Slot voor verdeelkasten
Serrure pour coffrets de distribution



BESTELNUMMER N° DE COMMANDE	Specificiteit Spécificités
LOCKDM	Serie D

VERDEELKASTEN COFFRETS DE DISTRIBUTION

Installatieset voor verdeelkast
Set d'installation pour coffret de distribution



BESTELNUMMER N° DE COMMANDE	
NSET-C-D	1

Installatie/vervangset voor serie C en D
Set d'installation/remplacement pour serie C et D

Verdeelkasten opbouw Type NEO / IP 65 In-100A
Coffrets de distribution en saillie Type NEO / IP 65 In-100A



BESTELNUMMER N° DE COMMANDE	MOD.	Afm. Dim.
RH18S	1 x 18	435x260x138 mm
RH36/2S	2 x 18	435x420x138 mm
RH54/3S	3 x 18	435x580x138 mm
RH72/4S	4 x 18	435x780x138 mm

Din rail en aardingsrail inclusief en geïnstalleerd
Rail Din et barrette de terre pré-installé



Slot voor verdeelkasten
Serrure pour coffrets de distribution



BESTELNUMMER N° DE COMMANDE	Specificiteit Spécificités
36.81	Serie NEO

Verdeelkasten opbouw IP 55 Incl. din rail
Coffrets de distribution en saillie IP 55



BESTELNUMMER N° DE COMMANDE	Ingangen Entrées	MOD.	Afm. Dim.
250-5AM	6xM20+4xM25	4 + 1	95x162x122 mm
250-9AM	6xM20+4xM25	8 + 1	98x162x202 mm
250-11AM	10xM25	10 + 1	109x232x182 mm



VERDEELKASTEN COFFRETS DE DISTRIBUTION

Verdeelkasten opbouw IP 55 Incl. din rail
Coffrets de distribution en saillie IP 55



BESTELNUMMER N° DE COMMANDE	Ingangen Entrées	MOD.	Afm. Dim.
250-9B	10 x PG21 met Nippels	8+1	98 X 162 X 202 mm



Afdekplaatjes voor MCB - Wit - 12 modulen
Couvercles universels pour MCB - Blanc - 12 modules



BESTELNUMMER N° DE COMMANDE	Afm. Dim.	
273MF	200x52x8 mm	10



Stopcontact voor borden - DIN Rail 35 mm
Prise de courant pour tableau - DIN Rail 35mm





BESTELNUMMER N° DE COMMANDE	A	Spanning Tension	
C500	16A	230V	1/5

VDE -EN 50 0 22

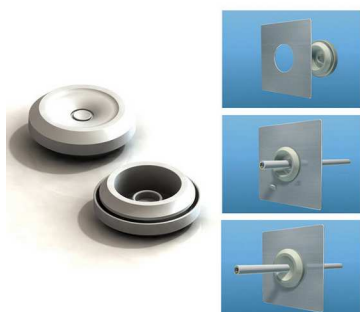

Kabeldoorvoer Quickseal M32
Cable transit Quickseal M32



BESTELNUMMER N° DE COMMANDE	Afm. Dim.	
TPQSM32	M32	10/100



VERDEELKASTEN COFFRETS DE DISTRIBUTION

Geïsoleerde klem voor DIN rails

Borniers isolés pour rails DIN



BESTELNUMMER N° DE COMMANDE	Ingangen Entrées	Kleur	Couleur	
N-12	12	blauw	bleu	10/100
N-15	15	blauw	bleu	10/200
N-7	7	blauw	bleu	10/200
PE-12	12	groen	vert	10/100
PE-15	15	groen	vert	10/200
PE-7	7	groen	vert	10/200

KAMGELEIDERS BARRE DE PONTAGE

Kamgeleiders met vork
Barre de Pontage avec fourche

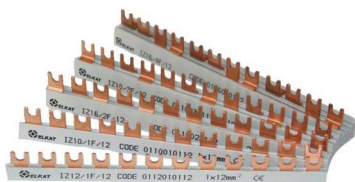

BESTELNUMMER N° DE COMMANDE	MOD.	FASES PHASES	∅	
IZ10/2F/54	54	L1,L2/N	10mm	20
IZ10/3F/54	54	L1,L2,L3	10mm	20
IZ16/2F/54	54	L1,L2/N	16mm	10
IZ16/3F/54	54	L1,L2,L3	16mm	20
IZ16/4F/56	56	L1,L2,L3,N	16mm	10
IZ16/4FN/54	54	L1 N L2 N L3 N	16mm	10

Lengte / Longueur: 1m

Kamgeleiders met pin
Barre de Pontage avec broche

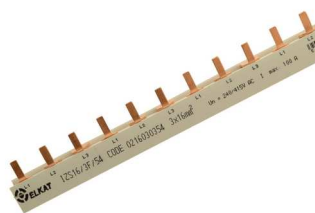

BESTELNUMMER N° DE COMMANDE	MOD.	FASES PHASES	∅	
IZS10/3F/54	54	L1,L2,L3	10mm	20
IZS16/2F/54	54	L1,L2/N	16mm	10
IZS16/3F/54	54	L1,L2,L3	16mm	20
IZS16/4F/56	56	L1,L2,L3,N	16mm	10

Lengte / Longueur: 1m

Eindstuk
Embout



BESTELNUMMER N° DE COMMANDE	Specificiteit Spécificités	∅	Polen Poles	
Z102F	IZ10/2F/54	10 mm ²	3	10/250
Z103F	IZ10/3F/54	10 mm ²	3	10/250
Z162F	IZ16/2F/54	16 mm ²	2	10/250
Z163F	IZ16/3F/54	16 mm ²	3	10/250
Z164F	IZ16/4F(N)/56	16 mm ²	4	10/250
ZS102F	IZS10/2F/54	10 mm ²	3	10/250
ZS103F	IZS10/3F/54	10 mm ²	3	10/250
ZS162F	IZS16/2F/54	16 mm ²	2	10/250
ZS163F	IZS16/3F/54	16 mm ²	3	10/250
ZS164F	IZS16/4F/56	16 mm ²	4	10/250

VLOERDOZEN BOÏTE POUR SOL

Vloerdozen voor toebehoren 45 x 45

Boîtes sol pour accessoires 45 x 45



BESTELNUMMER N° DE COMMANDE	MOD.	Afm. Dim.
745-4C LG	4	146x250x56 mm
745-8C LG	8	250x250x56 mm
745-CRF748	4 - 8	*

* Inlegstuk Voor Beton Voor Vloerdozen 4 En 8 Modules

* Piece d'Encastrement Pour Beton Pour Les Boites Sol 4 Et 8 Modules



Kader voor vloerdoos voor gebruik in beton / chape

Cadre pour boîte sol pour chape de béton



BESTELNUMMER N° DE COMMANDE
CFR748



Polystyreen blok voor vloerdoos

Bloc Polystyrène pour boîte sol



BESTELNUMMER N° DE COMMANDE	MOD.
745-EPS4M	4
745-EPS8M	8

Dubbele afdekplaat + 2 stekkers RJ45 CAT 6

Plaque double + 2 connecteurs RJ45 CAT6



BESTELNUMMER N° DE COMMANDE	Specificiteit Spécificités
745-LAN	CAT 6



PVC BUIZEN EN TOEBEHOREN TUBES PVC ET ACCESSOIRES

Rechte buizen
Tubes rigides



BESTELNUMMER N° DE COMMANDE	ø IN	Lengte Longueur	
VD16-2M	16 mm	2 m	30/4050 m
VD20-2M	20 mm	2 m	30/4050 m
VD16	16 mm	3 m	111/5550 m
VD20	20 mm	3 m	111/5550 m
VD25	25 mm	3 m	57/5130 m
VD32	32 mm	3 m	57/4275 m
VD40	40 mm	3 m	30 m
VD50	50 mm	3 m	15 m

Light Grey = RAL 7035

*1.5m en 2m geen stockartikel / op bestelling

* 1.5m en 2m pas un produit de stock / sur demande

Rechte buizen
Tubes rigides



BESTELNUMMER N° DE COMMANDE	ø IN	Lengte Longueur	
VD16R-1.5M	16 mm	1,5 m	56 m
VD16 R-2M	16 mm	2 m	30/4050 m
VD20R-1.5	20 mm	1,5 m	56 m
VD20 R-2M	20 mm	2 m	30/4050 m
VD16 R	16 mm	3 m	111/5550 m
VD20 R	20 mm	3 m	111/5550 m
VD25R-1.5M	25 mm	1,5 m	29 m
VD25 R	25 mm	3 m	57/5130 m
VD32R-1.5M	32 mm	1,5 m	29 m
VD32 R	32 mm	3 m	57/4275 m
VD40 R	40 mm	3 m	30 m
VD50 R	50 mm	3 m	15 m
VD63R	63 mm		15 m

R = Dark Grey = RAL 7037

*1.5m en 2m geen stockartikel / op bestelling

* 1.5m en 2m pas un produit de stock / sur demande

Buizen HALOGEN FREE- PC
Tubes HALOGEN FREE - PC



BESTELNUMMER N° DE COMMANDE	ø	Lengte Longueur	
VD16 LLH	16 mm	3m	111/5550 m

Light Load (2442) : LLH

Lengte / Longueur: 3m

RAL 7035 / *Black RAL 9004

PC = polycarbonaat/polycarbonate



PVC BUIZEN EN TOEBEHOREN TUBES PVC ET ACCESSOIRES

Buizen HALOGEN FREE- PC
Tubes HALOGEN FREE - PC



BESTELNUMMER N° DE COMMANDE	∅	Lengte Longueur	
VD20 LLH	20 mm	3m	111/5550 m
VD20 LLHBLACK	20 mm*	3m	111/5550 m
VD25 LLH	25 mm	3m	57/5130 m
VD25 LLHBLACK	25 mm	3m	57/5130 m
VD32 LLH	32 mm	3m	57 /4275 m

Light Load (2442) : LLH
Lengte / Longueur: 3m
RAL 7035 / *Black RAL 9004
PC = polycarbonaat/polycarbonate



Buizen HALOGEN FREE - PC
Tubes HALOGEN FREE - PC



BESTELNUMMER N° DE COMMANDE	∅	
VD16 MLH	16 mm	111/5550 m
VD20 MLH	20 mm	111/5550 m

Medium Load (3442) : MLH - PC =
polycarbonaat/polycarbonate

Lengte / Longueur: 3m - RAL 7035



Buizen HALOGEN FREE - PC
Tubes HALOGEN FREE - PC



BESTELNUMMER N° DE COMMANDE	∅	
VD16 FLH	16 mm	111/5550 m
VD20 FLH	20 mm	111/5550 m
VD25 LH	25 mm	57/5130 m
VD32 LH	32 mm	57/4275 m
VD40 LH	40 mm	30 m
VD50 LH	50 mm	15 m
VD63 LH	63 mm	3 m

Heavy Load (4442) : FLH/LH
Lengte / Longueur: 3m
RAL 7035
PC = polycarbonaat/polycarbonate



PVC BUIZEN EN TOEBEHOREN TUBES PVC ET ACCESSOIRES

Buizen HALOGEN FREE PP met manchet
Tubes HALOGEN FREE PP avec manchon



BESTELNUMMER N° DE COMMANDE	∅	
VD20HFPPMOF	20 mm	102/5100 m
VD25HPPPMOF	25 mm	75/3750 m

Light Grey = RAL 7035
PP= polypropylène/polypropyleen



Buis halfzacht, met trekdraad
Tube semi rigide, avec tire-fil



BESTELNUMMER N° DE COMMANDE	∅	
ERFE20G	20 mm	100 m
ERFE25G	25 mm	50 m



Ribbenbuis
Flex



BESTELNUMMER N° DE COMMANDE	∅	
ECICTA20HFT	20 mm	100 m
ECICTA25HFT	25 mm	50 m
ECICTA20HF	20 mm*	100 m
ECICTA25HF	25 mm*	50 m

* ECICTA20HFT en / et 25HFT : Met trekdraad / Avec tire-fil



Moffen voor rechte PVC buis
Manchons pour conduite rigide en PVC



BESTELNUMMER N° DE COMMANDE	∅	RAL	
U407	16 mm	RAL 7035	100/2500
U408	20 mm	RAL 7035	100/1600
U409	25 mm	RAL 7035	25/1150

Light Grey = RAL 7035
R = Dark Grey = RAL 7037



PVC BUIZEN EN TOEBEHOREN TUBES PVC ET ACCESSOIRES

Moffen voor rechte PVC buis

Manchons pour conduite rigide en PVC



BESTELNUMMER N° DE COMMANDE	∅	RAL	
U410	32 mm	RAL 7035	25/600
U411	40 mm	RAL 7035	25
U412	50 mm	RAL 7035	5
U407 R	16 mm	RAL 7037	100/2500
U408 R	20 mm	RAL 7037	100/1600
U409 R	25 mm	RAL 7037	25/1150
U410 R	32 mm	RAL 7037	25/600
U411 R	40 mm	RAL 7037	25
U412 R	50 mm	RAL 7037	5
U413R	63 mm	RAL 7037	5

Light Grey = RAL 7035
R = Dark Grey = RAL 7037



Bochten 90° voor rechte PVC buis

Coudes 90° pour conduite rigide en PVC



BESTELNUMMER N° DE COMMANDE	∅	RAL	
C16VD	16 mm	RAL 7035	50/2000
C20VD	20 mm	RAL 7035	50/1000
C25VD	25 mm	RAL 7035	20/500
C32VD	32 mm	RAL 7035	5
C40VD	40 mm	RAL 7035	5
C50VD	50 mm	RAL 7035	3
C16VD R	16 mm	RAL 7037	50/2000
C20VD R	20 mm	RAL 7037	50/1000
C25VD R	25 mm	RAL 7037	20/500
C32VD R	32 mm	RAL 7037	5
C40VD R	40 mm	RAL 7037	5
C50VD R	50 mm	RAL 7037	3
C25VDLHBLACK	25 mm	RAL 9005	5

Light Grey = RAL 7035
R = Dark Grey = RAL 7037



PVC BUIZEN EN TOEBEHOREN TUBES PVC ET ACCESSOIRES

Eindtullen voor rechte PVC buis

Embouts pour conduite rigide en PVC



BESTELNUMMER N° DE COMMANDE	∅	RAL	
EC16	16 mm	RAL 7035	100/7000
EC20	20 mm	RAL 7035	100/5500
EC25	25 mm	RAL 7035	50/2500
EC16 R	16 mm	RAL 7037	100/7000
EC20 R	20 mm	RAL 7037	100/5500
EC25 R	25 mm	RAL 7037	50/2500

Light Grey = RAL 7035

R = Dark Grey = RAL 7037



Invoertule M20

Entrées tube M20



BESTELNUMMER N° DE COMMANDE	∅	
MIBR1620	16 & 20 mm	50/2000

Light Grey = RAL 7035



METALEN BUIZEN TUBE EN METAL

Metalen buizen, zonder schroefdraad - Galvanisch verzinkt

Tubes en métal, sans filetage - Galvanisé



BESTELNUMMER N° DE COMMANDE	Afm. Dim.	
010TARM016	M16 x 1,5	3 m/51 m
010TARM020	M20 x 1,5	3 m/30 m
010TARM025	M25 x 1,5	3 m/30 m
010TARM032	M32 x 1,5	3 m/21 m
010TARM040	M40 x 1,5	3 m/15 m
010TARM050	M50 x 1,5	3 m/15 m
010TARM063	M63 x 1,5	3 m/9 m

Conform EN 61386 21 - code 5557

LEVERBAAR PER LENGTE (Prijs op aanvraag) / LIVRABLE

PAR LONGUEUR (prix sur demande)

OP BESTELLING / SUR COMMANDE : INOX

Buis Zonder Schroefdraad - Rvs Aisi 304

Tubes INOX sans filetage



BESTELNUMMER N° DE COMMANDE	Afm. Dim.	
060TARMI20	M20	3 m - 30 m
060TARMI25	M25	3 m - 30 m
060TARMI32	M32	3 m - 21 m
060TARMI40	M40	3 m - 15 m
060TARMI50	M50	3 m - 15 m

Metalen bochten, zonder schroefdraad - Galvanisch verzinkt

Coudes en métal 90°, sans filetage - Galvanisé



BESTELNUMMER N° DE COMMANDE	∅	
020CARM016	M16	10
020CARM020	M20	10
020CARM025	M25	10
020CARM032	M32	10
020CARM040	M40	5
020CARM050	M50	5
020CARM063	M63	5

Conform EN 61386 21 - code 5557

OP BESTELLING / SUR COMMANDE : INOX

METALEN BUIZEN TUBE EN METAL

Metalen bochten, zonder schroefdraad - Rvs Aisi 304

Coudes en métal 90°, sans filetage - INOX



BESTELNUMMER N° DE COMMANDE	Afm. Dim.	
061CARM120	M20	5
061CARM125	M25	5
061CARM132	M32	5
061CARM140	M40	5
061CARM150	M50	1

Koppelstukken, zonder schroefdraad - Galvanisch verzinkt

Manchons sans filetage - Galvanisé



BESTELNUMMER N° DE COMMANDE	∅	
020MARM016	M16 - L45 mm	100
020MARM020	M20 - L50 mm	100
020MARM025	M25 - L55 mm	60
020MARM032	M32 - L65 mm	30
020MARM040	M40 - L70 mm	25
020MARM050	M50 - L90 mm	12
020MARM063	M63 - L105 mm	6

Conform EN 61386 21 - code 5557
OP BESTELLING / SUR COMMANDE : INOX

Koppelstukken, zonder schroefdraad - Rvs Aisi 304

Manchons sans filetage - INOX



BESTELNUMMER N° DE COMMANDE	Afm. Dim.	
061MACMI20	M20	12
061MACMI25	M25	8
061MACMI32	M32	5
061MACMI40	M40	3
061MACMI50	M50	2

Conform EN 61386 21 - code 5557
OP BESTELLING / SUR COMMANDE : INOX

BLACK & WHITE BLACK & WHITE

Rechte buis
Tube rigide



BESTELNUMMER N° DE COMMANDE	∅	Lengte Longueur	
VD20 Black	20 mm	3m	111m
VD20 White	20 mm	3m	111m
VD20 Black-2M	20 mm	2m	30m*
VD20 White-2M	20 mm	2m	30m*
VD20 LLHBLACK	20 mm*	3m	111/5550 m
VD25 LLHBLACK	25 mm	3m	57/5130 m

Lengte / Longueur: 3m
*Lengte / Longueur: 2m
White = RAL 9003
Black = RAL 9004

Eindstuk
Embout



BESTELNUMMER N° DE COMMANDE	Afm. Dim.	
EC20 Black	20 mm	100 / 5500
EC20 White	20 mm	100 / 5500

Black = RAL 9004
White = RAL 9003



PVC Stop
Bouchon PVC



BESTELNUMMER N° DE COMMANDE	Afm. Dim.	
907M20 Black	20 mm	50 / 2000

Black = RAL 9004



BLACK & WHITE BLACK & WHITE

Buisinvoer
Entrée tube



BESTELNUMMER N° DE COMMANDE	Afm. Dim.	
MIBR1620 Black	16/20 mm	50 / 2000
MIBR1620 White	16/20 mm	50 / 2000

White = RAL 9003
Black = RAL 9004



Mof
Manchon



BESTELNUMMER N° DE COMMANDE	Afm. Dim.	
U408 White	20 mm	50 / 1600
U408 Black	20 mm	100 / 1600
U409 Black	25 mm	25 / 1125

White = RAL 9003
Black = RAL 9004



Veerkleem Black & White
Attache ressort Black & White



BESTELNUMMER N° DE COMMANDE	Afm. Dim.	
204 White	20 mm	100 / 3000
204 Black	20 mm	100 / 3000
208 Black	25 mm	50 / 1500

White = RAL 9003
Black = RAL 9004



Aaneenschuifbare drukklemmen
Attaches à pression à juxtaposer



BESTELNUMMER N° DE COMMANDE	Afm. Dim.	
2036 Black	12 - 20 mm	50 / 1500
2037 Black	16 - 26 mm	50 / 1500

Black = RAL 9004



BLACK & WHITE BLACK & WHITE

Nagelclips - Platte Kabel - Wit
 Attaches à clouer - câble plat - Blanc



BESTELNUMMER N° DE COMMANDE	∅	
702-2W	2 x 1,5	100



Nagelclips - maten in mm
 Attaches à clouer - mesures en mm



BESTELNUMMER N° DE COMMANDE	∅	
3007-18Black	7 mm*	100 /12800

De 2 laatste cijfers van het bestelnummer duiden de lengte van de nagel aan. Kleur: Grijs
 Les 2 derniers chiffres du n° de commande indiquent la longueur du clou. Couleur: Gris
 *Zwart / Noire



Wartel
 Presse-étoupe



BESTELNUMMER N° DE COMMANDE	Afm. Dim.	
BM20 White	20 mm	50 / 2000
BM20 Black	20 mm	50 / 2000

White = RAL 9003
 Black = RAL 9004



Boxline kabeldoos schroefingangen M20
 Boxline boîte de dérivation filetage M20



BESTELNUMMER N° DE COMMANDE	Ingangen Entrées	∅	Afm. Dim.	
J100S Black	7	M20	102²x56 mm	1 / 90
J100S White	7	M20	102²x56 mm	1 / 90

White = RAL 9003
 Black = RAL 9004



BLACK & WHITE BLACK & WHITE

Kabeldoos thermoplast

Boîte de dérivation thermoplastique



BESTELNUMMER N° DE COMMANDE	Ingangen Entrées	Afm. Dim.	
FE25 Black	10	89 x 43 x 37 mm	10 / 150
FE25 White	10	89 x 43 x 37 mm	10 / 150
FE7 Black	7	75x75x37	10/300

Black = RAL 9004

White = RAL 9010

ø 1,5-4mm



Kanalen Inway zwart

Goulotte Inway noir



Voor meer informatie, zie hoofdstuk kanalen vanaf p.107
Pour plus d'info, cf. chapitre goulottes à partir de p. 107

WARTELS PRESSE-ETOUPES

Wartels - Pg reeks

Presse-étoupes - Série Pg



BESTELNUMMER N° DE COMMANDE	∅	
90507	PG7	50
90509	PG9	50 / 3750
90511	PG11	50 / 2700
90513	PG13,5	50 / 2700
90516	PG16	50 / 1850
90521	PG21	20 / 1080
90529	PG29	20 / 440
90536	PG36	10 / 220
90548	PG48	5

Polystyrol
Schokbestendig / Résistant au choc
Wurtring in rubber / Bague d'échanchéité en caoutchouc
Drukrondel in gegalvaniseerd ijzer / Rondelle de pression en acier galvanisé
IP 65 – 5°C à + 60°C



Wartels met trekontlasting - Pg reeks

Presse-étoupes à serrage - Série Pg



BESTELNUMMER N° DE COMMANDE	∅	
9707-ORL01	PG7	100
9709-ORL02	PG9	100
9711-ORL03	PG11	100
9713-ORL04	PG13,5	100
9716-ORL05	PG16	50
9721-ORL06	PG21	50
9729-ORL07	PG29	25
9736-ORL08	PG36	10
9748-ORL10	PG48	5

Polyamide met TPE rubber / Bague TPE
IP 68 –30°C à + 80°C



WARTELS PRESSE-ETOUPES

Tegenmoeren - Pg reeks
Contre-écrous - Série Pg



BESTELNUMMER N° DE COMMANDE	∅	
90607	PG7	50
90609	PG9	50
90611	PG11	50
90613	PG13,5	50 / 5600
90616	PG16	50 / 5600
90621	PG21	20 / 2240
90629	PG29	20 / 2240
90636	PG36	10
90648	PG48	10

Polystyrol / Polystyrene
Schokbestendig / Résistant au choc
- 5°C à + 60°C
DIN 46320 - L



Stoppen - Pg reeks
Bouchons - Série Pg



BESTELNUMMER N° DE COMMANDE	∅	
90707	PG7	100
90709	PG9	100
90711	PG11	100
90713	PG13,5	50
90716	PG16	50
90721	PG21	50
90729	PG29	50
90736	PG36	50
90748	PG48	25

Polystyrol / Polystyrene
Schokbestendig / Résistant au choc
- 5°C à + 60°C
DIN 46320 - N



WARTELS PRESSE-ETOUPES

Wartels - Metrische reeks

Presse-étoupes - Série Métrique IP54



BESTELNUMMER N° DE COMMANDE	∅	
905M12-DMRL01	12 mm	50
905M16-DMRL03	16 mm	100
905M20-DMRL04	20 mm	100
905M25-DMRL06	25 mm	50

Polyamide / IP 54 / -30°C / +80°C,
TPV Rubber / Bague TPV, EN60423



Wartels met trekontlasting - Metrische reeks IP68

Presse-étoupes à serrage - Série Métrique IP68



BESTELNUMMER N° DE COMMANDE	∅	
BM12	12 mm	50 / 2000
BM16	16 mm	50 / 2000
BM20	20 mm	50 / 2000
BM25	25 mm	20 / 800
BM32	32 mm	20 / 600
BM40	40 mm	10 / 300
BM50	50 mm	5 / 200
BM63	63 mm	5 / 120

Met skintop en trekontlasting
Avec skintop et serrage étendu
Polyamide / IP 68 / -20°C / +125°C



Wartels MULTIHOLE met trekontlasting - Metrische reeks IP65

Presse-étoupes MULTIHOLE à serrage - Série Métrique IP6

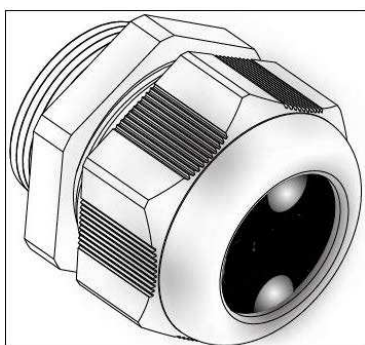

BESTELNUMMER N° DE COMMANDE	Ingangen Entrées	∅
OMRL05A7	2 x 7 mm	M20

IP65, -30°C / +80°C, RAL7035
Andere configuraties op aanvraag
Autres configurations sur demande



WARTELS PRESSE-ETOUPES

Tegenmoeren - Metrische reeks
 Contre-écrous - Série Métrique



BESTELNUMMER N° DE COMMANDE	∅	
PM12	12 mm	50/4800
PM16	16 mm	50/4800
PM20	20 mm	50/4800
PM25	25 mm	20/1920
PM32	32 mm	20/1920
PM40	40 mm	10/960
PM50	50 MM	10/480
PM63	63 MM	5/480

Polyamide
 RAL7035
 - 20°C / +125°C



Stoppen - Metrische reeks
 Bouchons - Série Métrique



BESTELNUMMER N° DE COMMANDE	∅	
907M12	12 mm	100
907M16	16 mm	100
907M20	20 mm	100
907M25	25 mm	25
907M32	32 mm	20
907M40	40 mm	10
907M50	50 mm	4
907M63	63 mm	4

Polyamide
 RAL7035
 - 30°C / +80°C



Wurgnippels - Metrische reeks
 Raccords à visser - Série Métrique



BESTELNUMMER N° DE COMMANDE	∅	
908M16	16 mm	100
908M20	20 mm	100

Polyamide
 RAL7035
 - 30°C / +80°C



WARTELS PRESSE-ETOUPES

Wurgnippels - Metrische reeks
Raccords à visser - Série Métrique



BESTELNUMMER N° DE COMMANDE	∅	
908M25	25 mm	100
908M32	32 mm	50
908M40	40 mm	25
908M50	50 mm	10

Polyamide
RAL7035
- 30°C / +80°C



Drukmoeren - Metrische reeks
Boulons de pression - Série Métrique



BESTELNUMMER N° DE COMMANDE	∅	
909M16	16 mm	100
909M20	20 mm	100



Vergrotingen - Metrische reeks
Augmentations - Série Métrique



BESTELNUMMER N° DE COMMANDE	∅ IN	∅	
ME1216	M16	M12	100
ME1620	M20	M16	100
ME2025	M25	M20	100
ME2532	M32	M25	50
ME3240	M40	M32	50

Polystyrol / IP 65 / - 5°C / + 60°C



WARTELS PRESSE-ETOUPES

Verkleiningen - Metrische reeks

Réductions - Série Métrique



BESTELNUMMER N° DE COMMANDE	ø IN	ø	
MR1612	M12	M16	100
MR2012	M12	M20	100
MR2016	M16	M20	100
MR2512	M12	M25	100
MR2516	M16	M25	100
MR2520	M20	M25	100
MR3212	M12	M32	50
MR3216	M16	M32	50
MR3220	M20	M32	50
MR3225	M25	M32	50
MR4016	M16	M40	50
MR4020	M20	M40	50
MR4025	M25	M40	50
MR4032	M32	M40	50
MR5020	M20	M50	25
MR5025	M25	M50	25
MR5032	M32	M50	25
MR5040	M40	M50	25
MR6325	M25	M63	25
MR6332	M32	M63	25
MR6340	M40	M63	25
MR6350	M50	M63	25



VEERKLEMMEN ATTACHES RESSORT

veerklemmen
Attaches ressort



BESTELNUMMER N° DE COMMANDE	∅	
108	50 mm	25 / 600

M6 Polyamide
Kleur : grijs
Couleur : gris



Aaneenschuifbare veerklemmen
Attaches ressort à juxtaposer



BESTELNUMMER N° DE COMMANDE	∅	
211	16 mm	100 / 4000
204	20 mm	100 / 3000
208	25 mm	50 / 1500
209	32 mm	50 / 1500
210	40 mm	25 / 750

M6 Polyamide
Kleur : grijs
Couleur : gris



Aaneenschuifbare drukklemmen
Attaches pression à juxtaposer



BESTELNUMMER N° DE COMMANDE	∅	
2035	6 - 13 mm	50 / 3750
2036	12 - 20 mm	50 / 1500
2037	16 - 26 mm	50 / 1500
2038	18 - 30 mm	50 / 1200
2039	27 - 43 mm	25 / 750

M6 Polyamide
Kleur : grijs
Couleur : gris



VEERKLEMMEN ATTACHES RESSORT

Universele klemmen
Attaches universelles





BESTELNUMMER N° DE COMMANDE	∅	
031G	16 - 22 mm	50 / 2700
031T	16 - 22 mm	50 / 2700

Kleur : Grijs of transparant
Couleur : Gris ou transparent

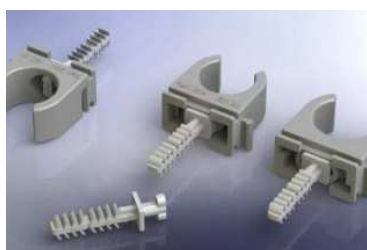

Veerklem met Plug M6
Attache Ressort avec Cheville M6



BESTELNUMMER N° DE COMMANDE	∅	
204D	20 mm	50/2000
211D	16 mm	100/4000

M6 Polyamide
Kleur : grijs
Couleur : gris



Drukklem met Plug M6
Attaches pression avec Cheville M6



BESTELNUMMER N° DE COMMANDE	∅	
2036D	12 - 20 mm	50 / 1500
2037D	16 - 24 mm	50 / 1200

M6 Polyamide
Kleur : grijs
Couleur : gris



SUPER T SUPER T

Aaneenschuifbare klem SUPER T
 Attache à juxtaposer SUPER T



BESTELNUMMER N° DE COMMANDE	∅	
ST16	16 mm	100/3000
ST20	20 mm	100/3000
ST25	25 mm	100/3000
ST32	32 mm	100/3000
ST40	40 mm	50/1500

M6 Polyamide
 Kleur : grijs
 Couleur : gris



Deksel voor SUPER T
 Couvercle pour SUPER T



BESTELNUMMER N° DE COMMANDE	Afm. Dim.	
STC16	16 mm	100/9600
STC20	20 mm	100/9600
STC25	25 mm	100/9600
STC32	32 mm	100/9600
STC40	40 mm	50/4800



Plug M6 voor veer- en drukklommen
 Cheville M6 pour attaches ressort et à pression



BESTELNUMMER N° DE COMMANDE	
20436	100

M6 Polyamide
 Kleur : grijs
 Couleur : gris
 3 posities / 3 positions



SUPER T SUPER T

Plug M6 voor veer- en drukklemmen

Cheville M6 pour attaches ressort et à pression



BESTELNUMMER N° DE COMMANDE	Specificiteit Spécificités	
PST-5	27 mm	100/9600
PST-7	42 mm	100/9600

M6 Polyamide
Kleur : grijs
Couleur : gris
1 positie / 1 position



Montageplug M6 voor beton voor klem SUPER T

Cheville de montage M6 pour béton pour SUPER T



Micro Adjustment with 10 steps
10 mm total amplitude



BESTELNUMMER N° DE COMMANDE	Afm. Dim.	
PSTB-4	27 mm	100/9600
PSTB-7	42 mm	100/9600

M6 Polyamide
Kleur : grijs
Couleur : gris
10 posities / 10 positionS



Montageplug voor metalen plaat voor klem SUPER T

Cheville de montage pour plaque de métal pour SUPER T

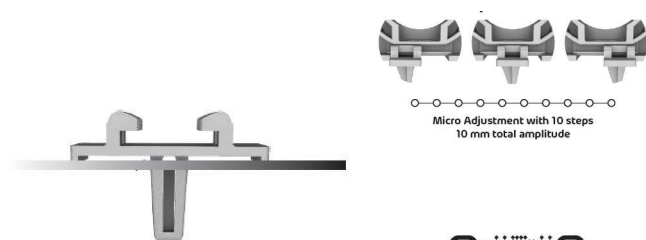

Micro Adjustment with 10 steps
10 mm total amplitude



BESTELNUMMER N° DE COMMANDE	
ST-CLIP	100/14400

Polyamide
Kleur : grijs
Couleur : gris
10 posities / 10 positionS
Ook voor kabelbinders / aussi pour colliers de câblage



SUPER T SUPER T

Montageplug voor gebruik met siliconen voor klem SUPER T

Cheville de montage pour usage avec sillicon pour SUPER T

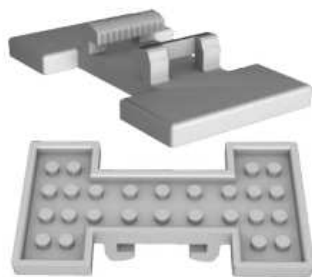

Multiple Positions



Micro Adjustment with 10 steps
10 mm total amplitude



BESTELNUMMER
N° DE COMMANDE



ST-BASE

100/9600

Polyamide

Kleur : grijs

Couleur : gris

10 posities / 10 positionS

Ook voor kabelbinders / aussi pour colliers de câblage



KLEMMEN ATTACHES

Vorkklemmen
Attaches fourchette



BESTELNUMMER N° DE COMMANDE	∅	
512	10 mm	100/1000
513	12 mm	100/1000
514	13,5 - 15 mm	100/5400
515	14 - 15 mm	100/1000
516	16 - 18 mm	50/2500
517	20 - 22 mm	50/2500
518	22 - 25 mm	50/2700
519	35 mm	30/1080
520	42 mm	20/720

M6 Polyamide
Grijs / gris



Vorkklemmen dubbel
Attaches fourchette double



BESTELNUMMER N° DE COMMANDE	∅	
512-2	10 mm	50/500
513-2	12 mm	50/1000
515-2	14 - 15 mm	50/1000
516-2	16 - 18 mm	25/1350
517-2	20 - 22 mm	25/1350
518-2	25 - 28 mm	20/720

Voor gelijktijdige bevestiging van 2 kabels of buizen
Pour fixation simultane de 2 cables ou tubes
M6 Polyamide
Grijs / gris



KZM kabelzadels
KZM attaches



BESTELNUMMER N° DE COMMANDE	∅	
905	5 - 14 mm	100/4000
906	6 - 17 mm	50/2000
907	15 - 25 mm	50/1200
908	24 - 34 mm	25/750

Polypropyleen/Polypropylène
Vijs in polystyrol/Vis en polystyrol



KLEMMEN ATTACHES

KZM kabelzadels dubbel
KZM attaches double



BESTELNUMMER N° DE COMMANDE	∅	
906-2	6 - 17 mm	50/1500

Polypropyleen/Polypropylène
Vijs in polystyrol/Vis en polystyrol



Kabelhouder
Attaches câble



BESTELNUMMER N° DE COMMANDE	Normes	Afm. Dim.
710-15	Max. 10kg	38x69 mm
710-30	Max. 10kg	42x106 mm



Slagklemmen
Attaches intercalaires



BESTELNUMMER N° DE COMMANDE	∅	
2047	5 - 25 mm	100 / 5400
2048	8 - 38 mm	100 / 3000

Snelle montage voor rail 761 & 2761
Fixation rapide pour rail 761 & 2761



Railklemmen
Attaches pour rail avec vis



BESTELNUMMER N° DE COMMANDE	∅	
2050	7 - 25 mm	100 / 5400
2051	13 - 38 mm	100 / 3000

Voor rail 761 & 2761
Pour rail 761 & 2761



KLEMMEN ATTACHES

Aaneenschuifbare 'Clic' klemmen
Attaches 'Clic' à juxtaposer



BESTELNUMMER N° DE COMMANDE	∅	
701516	15 - 16 mm	50/1350
701920	20 - 22 mm	50/900
702225	25 -28 mm	50/400
703235	32 -35 mm	50/800



IJZER ZADELS ATTACHES EN ACIER

Klembeugels "Marine"
Attaches "Marine"



BESTELNUMMER N° DE COMMANDE	∅	
9700012	12 mm	300 / 1200
9700016	16 mm	250 / 1000
9700020	20 mm	200 / 800
9700025	25 mm	150 / 600
9700028	28 mm	125 / 500

Afmetingen / Dimensions : 20 x 1,25 mm
Gat / Trou : 5 mm

Klembeugels "Speed" Enkel
Attaches "Speed" Simple



BESTELNUMMER N° DE COMMANDE	∅	
9701016	16 mm	250 / 1000
9701020	20 mm	175 / 700
9701025	25 mm	150 / 600

Schietbeugel
Attache pour tirer

Klembeugels "Speed" dubbel
Attaches "Speed" double



BESTELNUMMER N° DE COMMANDE	∅	
9700316	2 x 16 mm	100 / 400
9700320	2 x 20 mm	75 / 300
9700325	2 x 25 mm	50 / 200

Schietbeugel
Attache pour tirer

IJzeren inslagbeugel
Attache à frapper en métal



BESTELNUMMER N° DE COMMANDE	∅	
9100900	16 - 20 mm	500 / 2000

IJZER ZADELS ATTACHES EN ACIER

IJzeren zadels - rood gelakt

Attaches en acier - rouge laquée



BESTELNUMMER N° DE COMMANDE	∅	
9100001	16 mm	500 / 2000
9100002	20 mm	350 / 1400
9100004	25 mm	150 / 600
9100005	32 mm	100 / 400
9100026	40 mm	75 / 300
9100007	50 mm	50 / 200
9100029	2 x 16 mm	250 / 1000
9100030	3 x 16 mm	200 / 800
9100031	4 x 16 mm	150 / 600
9100066	2 x 20 mm	200 / 800
9100067	3 x 20 mm	150 / 600

IJzeren zadels - verzinkt

Attaches en acier - galvanisé



BESTELNUMMER N° DE COMMANDE	∅	
9100116	16 mm	500 / 2000
9100120	20 mm	350 / 1400
9100126	25 mm	150 / 600
9100132	32 mm	100 / 400
9100140	40 mm	75 / 300
9100150	50 mm	50 / 200
9100037	2 x 16 mm	250 / 1000
9100038	3 x 16 mm	200 / 800
9100707	4 x 16 mm	150 / 600
9100046	2 x 20 mm	200 / 800
9100047	3 x 20 mm	150 / 600

Zadels enkel pad - gegalvaniseerd

Attaches simple patte - galvanisé



BESTELNUMMER N° DE COMMANDE	∅	
9700916	16 mm	500 / 2000
9700920	20 mm	350 / 1400
9700925	25 mm	150 / 600

IJZER ZADELS ATTACHES EN ACIER

Zadels in U-vorm - rood gelakt

Attaches en forme U - rouge laquée



BESTELNUMMER N° DE COMMANDE	∅	
9100056	16 mm	500 / 2000
9100057	20 mm	350 / 1400
9100903	25 mm	150 / 600

FUNCTIEBEHOUD MAINTIEN DE FONCTION

FBB beugel, inclusief schroefanker - E90

Attache, cheville à visser incluse - E90



BESTELNUMMER N° DE COMMANDE	∅	
9700806	6 mm	200 / 800
9700808	8 mm	200 / 800
9700810	10 mm	200 / 800
9700812	12 mm	200 / 800
9700814	14 mm	150 / 600
9700816	16 mm	150 / 600
9700819	19 mm	150 / 600
9700825	25 mm	100 / 400
9702816	16 mm	75/300
9702819	19 mm	75/300
9700850	*1	
9700855	*2	
9700860	*3	
9230460	*4	

Per verpakking een SDS boor (torx bitje) inclusief

*1 Schroefanker - TSM

*2 Schroefbit - Torx 25 - 1 /4"

*3 SDS functiebehoudboor - dia. 5x110

*4 Duimnagel E30 - E90 - E120

Une mèche SDS (torx) incluse par emballage

*1 Vis maintien de fonction - TSM

*2 nr 25 Embout de vissage - Torx 25 - 1/4"

*3 Mèche SDS - dia. 5x110

*4 Cheville à Pousser E30 - E90 - E120



FBB beugel, inclusief inslaganker - E90

Attache, cheville à frapper incluse - E90



BESTELNUMMER N° DE COMMANDE	∅	
9700826	6 mm	200 / 800
9700828	8 mm	200 / 800
9700830	10 mm	200 / 800
9700832	12 mm	200 / 800
9700834	14 mm	150 / 600
9700836	16 mm	150 / 600
9700839	19 mm	150 / 600
9700845	25 mm	100 / 400

*1 SDS functiebehoudboor - dia. 6x110

*2 Inslaganker TDN 6/35

*1 Mèche SDS - dia. 6x110

*2 Cheville à frapper maintien de fonction TDN 6/35



FUNCTIEBEHOUD MAINTIEN DE FONCTION

FBB beugel, inclusief inslaganker - E90

Attache, cheville à frapper incluse - E90



BESTELNUMMER N° DE COMMANDE	∅	
9702836	16 mm	75/300
9702839	19 mm	75/300
9700880	*2	
9700875	*1	

*1 SDS functiebehoudboor - dia. 6x110

*2 Inslaganker TDN 6/35

*1 Mèche SDS - dia. 6x110

*2 Cheville à frapper maintien de fonction TDN 6/35



FBB Beugel en Duim Nagel

Attache + cheville à pousser maintien de fonction



BESTELNUMMER N° DE COMMANDE	Omschrijving	Description	∅	
9700817	Enkel	Simple	16 mm	150/ 600
9700820	Enkel	Simple	19 mm	150/ 600
9702817	Dubbel	Double	16 mm	150/ 600
9702820	Dubbel	Double	19 mm	150/ 600



Klem voor buis en kabel met eenzijdige schuifbare sluiting

Collier pour câble et tube-fermeture unilatérale coulisse



BESTELNUMMER N° DE COMMANDE	∅	
5605-16	14-18 mm	100/1300
5605-22	19-23 mm	75/1200
5605-28	24-28 mm	50/1000
5605-38	30-38 mm	40/640
5605-50	39-52 mm	30/360
5605-60	53-61 mm	20/200

E60 (volgens/selon DIN 4102-12)

Ook / aussi : INOX



FUNCTIEBEHOUD MAINTIEN DE FONCTION

Verzamelbeugel Cable guide Functiebehoudbevestiging

Collier pour câbles à maintient de fonction



BESTELNUMMER N° DE COMMANDE	Afm. Dim.	
9702845	74x73 mm	1/36

E30-E90



Functiebehoud Kabeldrager in metaal

Attache pour câble en métal à maintien de fonction



BESTELNUMMER N° DE COMMANDE	∅	
28481	60	50
28483	88	25

Functiebehoud E30 en E60. Conform DIN4102-12
Tenue de fonction anti feu E30 et E60. DIN4102-12



Clipsen

Clips



BESTELNUMMER N° DE COMMANDE	Oud Ref. Ancienne réf.	Dikte profiel Epaisseur profil	
FH4-DT	SI100DT	1,5 - 4 mm	100
FH10-DT	SI101DT	4 - 10 mm	100
FH15-DT	SI102DT	10 - 15 mm	100
FH20-DT	SI103DT	15 - 20 mm	100

Voor draadstang

Pour tiges filetées



BESTELNUMMER N° DE COMMANDE	Oud Ref. Ancienne réf.	Dikte profiel Epaisseur profil	
FH20-ICA10DT	SI103-212DT	15 - 20 mm / M10	100
FH15-ICA10DT	SI102-212DT	10 - 15 mm / M10	100
FH4-ICA8DT	SI100-211DT	1,5 - 4 mm / M8	100
FH15-ICA8DT	SI102-211DT	10 - 15 mm / M8	100

FUNCTIEBEHOUD MAINTIEN DE FONCTION

Voor draadstang
Pour tiges filetées



BESTELNUMMER N° DE COMMANDE	Oud Ref. Ancienne réf.	Dikte profiel Epaisseur profil	
FH20-ICA6DT	SI103-210DT	15 - 20 mm / M6	100
FH20-ICA8DT	SI103-211DT	15 - 20 mm / M8	100
FH10-ICA8DT	SI101-211DT	4 - 10 mm / M8	100
FH10-ICA6DT	SI101-210DT	4 - 10 mm / M6	100
FH15-ICA6DT	SI102-210DT	10 - 15 mm / M6	100
FH4-ICA6DT	SI100-210DT	1,5 - 4 mm / M6	100
FH4-ICA10DT	SI100-212DT	1,5 - 4 mm / M10	100
FH10-ICA10DT	SI101-212DT	4 - 10 mm / M10	100

Voor kabelbinder
Pour Collier de Câblage



BESTELNUMMER N° DE COMMANDE	Oud Ref. Ancienne réf.	Dikte profiel Epaisseur profil	
FH20-BRDT	SI103-250DT	15 - 20 mm	100
FH15-BRDT	SI102-250DT	10 - 15 mm	100
FH10-BRDT	SI101-250DT	4 - 10 mm	100
FH4-BRDT	SI100-250DT	1,5 - 4 mm	100

Klem - M6x9
Attache - M6x9



BESTELNUMMER N° DE COMMANDE	Oud Ref. Ancienne réf.	Dikte profiel Epaisseur profil	
FU7TM6DT	SI104TM6DT	3 - 7 mm	100
FU12-5TM6DT	SI105TM6DT	7 - 13 mm	100
FU20TM6DT	SI106TM6DT	14 - 20 mm	100

BEUGELS - FUNCTIEBEHOUD ATTACHE - MAINTIEN DE FONCTION

Klem - M8x14

Attache - M8x14



BESTELNUMMER N° DE COMMANDE	Oud Ref. Ancienne réf.	Dikte profiel Epaisseur profile	
FU7TM8DT	SI104TM8DT	3 - 7 mm	100
FU12-5TM8DT	SI105TM8DT	7 - 13 mm	100
FU20TM8DT	SI106TM8DT	14 - 20 mm	100

Klem - M8x14 Zonder Schroef

Attache - M8x14 sans vis



BESTELNUMMER N° DE COMMANDE	Oud Ref. Ancienne réf.	Dikte profiel Epaisseur profile	
FU7DT	SI104DT	3 - 7 mm	100
FU12-5DT	SI105DT	7 - 13 mm	100
FU20DT	SI106DT	14 - 20 mm	100

Klem

Attache



BESTELNUMMER N° DE COMMANDE	Oud Ref. Ancienne réf.	Dikte profiel Epaisseur profile	
SB17-11DT	SI130DT	max. 16 mm	100

CLIPS

CLIPS



BESTELNUMMER N° DE COMMANDE	Oud Ref. Ancienne réf.	∅	Dikte profiel Epaisseur profile	
CD4-9DT	SI306DT	8 - 9 mm	1 - 4 mm	100
CD7-5-9DT	SI307DT	8 - 9 mm	4 - 7,5 mm	100
CD12-9DT	SI307.2DT	8 - 9 mm	7,5 - 12 mm	100
CD4-11DT	SI308DT	10 - 11 mm	1 - 4 mm	100

BEUGELS - FUNCTIEBEHOUD ATTACHE - MAINTIEN DE FONCTIONNEMENT

CLIPS
CLIPS



BESTELNUMMER N° DE COMMANDE	Oud Ref. Ancienne réf.	∅	Dikte profiel Epaisseur profile	
CD7-5-11DT	SI309DT	10 - 11 mm	4 - 7,5 mm	100
CD12-11DT	SI309.2DT	10 - 11 mm	7,5 - 12 mm	100
CD4-14DT	SI310DT	12 - 14 mm	1 - 4 mm	100
CD7-5-14DT	SI311DT	12 - 14 mm	4 - 7,5 mm	100
CD12-14DT	SI311.2DT	12 - 14 mm	7,5 - 12 mm	100
CD4-18DT	SI312DT	15 - 18 mm	1 - 4 mm	100
CD7-5-18DT	SI313DT	15 - 18 mm	4 - 7,5 mm	100
CD12-18DT	SI313.2DT	15 - 18 mm	7,5 - 12 mm	100
CD4-24DT	SI314DT	19 - 24 mm	1 - 4 mm	100
CD7-5-24DT	SI315DT	19 - 24 mm	4 - 7,5 mm	100
CD12-24DT	SI315.2DT	19 - 24 mm	7,5 - 12 mm	100
CD4-30DT	SI316DT	25 - 30 mm	1 - 4 mm	100
CD7-5-30DT	SI317DT	25 - 30 mm	4 - 7,5 mm	100
CD12-30DT	SI317.2DT	25 - 30 mm	7,5 - 12 mm	100

Rapid RTB dakplaathanger V model
Attache RTB pour plaque de toit en V



BESTELNUMMER N° DE COMMANDE	Afm. Dim.	Dikte profiel Epaisseur profile	
9004121	M8 / M10	0.63 mm	50

TYPE RTB 8/10

BEUGELS - FUNCTIEBEHOUD ATTACHE - MAINTIEN DE FONCTIONNEMENT

Ponstang

Poinçon pour plaque de toit en V

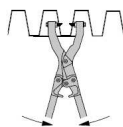

BESTELNUMMER
N° DE COMMANDE

9004510



1

ISOLATIETAPE RUBAN ISOLANT

Isolatietape 0,15 mm x 19 mm x 20 m

Ruban isolant 0,15 mm x 19 mm x 20 m



BESTELNUMMER N° DE COMMANDE	Kleur	Couleur	
TP151920BK	zwart	noir	10 / 250
TP151920BL	blauw	bleu	10 / 250
TP151920BN	bruin	brun	10 / 250
TP151920GRN	groen	vert	10 / 250
TP151920GY	groen-geel	vert-jaune	10 / 250
TP151920RD	rood	rouge	10 / 250
TP151920WT	wit	blanc	10 / 250
TP151920YL	geel	jaune	10 / 250
TP151920GR	grijs	gris	10 / 250

Vlamvertragend BSEN 60454-2
Flame retardant BSEN 60454-2

Isolatietape 0,15 mm x 50 mm x 20 m

Ruban isolant 0,15 mm x 50 mm x 20 m



BESTELNUMMER N° DE COMMANDE	Kleur	Couleur	
TP155020RD	rood	rouge	1 / 100
TP155020YL	geel	jaune	1 / 100

Vlamvertragend BSEN 60454-2
Flame retardant BSEN 60454-2

SNELMONTAGE FIXATION RAPIDE

Universele nagelclips
Clips à clouer universels



BESTELNUMMER N° DE COMMANDE	∅	
700-02	2,5 - 4 mm	100 /12800
700-05	5 - 7 mm	100 /12800
700-08	8 - 10 mm	100 /9600
700-11	11 - 15 mm	100 /7500
700-16	16 - 19 mm	50 /2000
700-23	23 - 29 mm	50 /250
700-08 Black	8 - 10 mm *	100 /9600

Met slechts 6 types alle maten in voorraad. Kleur: Grijs
Avec seulement 6 types toutes dimensions en stock. Couleur: Gris
* Black



Nagelclips - maten in mm
Attaches à clouer - mesures en mm



BESTELNUMMER N° DE COMMANDE	∅	
3004-18	4 mm	100 /12800
3005-18	5 mm	100 /12800
3006-18	6 mm	100 /12800
3007-18	7 mm	100 /12800
3008-20	8 mm	100 /12800
3009-20	9 mm	100 /12800
3010-35	10 mm	100 /12800
3011-35	11 mm	100 /12800
3012-35	12 mm	50 / 6400
3014-40	14 mm	50 / 5400
3016-40	16 mm	25 / 3250
3018-40	18 mm	25 / 3200
3020-40	20 mm	25 / 3200
3007-18Black	7 mm*	100 /12800

De 2 laatste cijfers van het bestelnummer duiden de lengte van de nagel aan. Kleur: Grijs
Les 2 derniers chiffres du n° de commande indiquent la longueur du clou. Couleur: Gris
*Zwart / Noire



SNELMONTAGE FIXATION RAPIDE

Nagelclips - maten in mm

Attaches à clouer - mesures en mm



BESTELNUMMER N° DE COMMANDE	ø IN	
OL70211	3/4 mm	100 /10000
OL70212	5/6 mm	100 /10000
OL70213	7/8 mm	100 /10000
OL70214	9/10 mm	100 /10000
OL70215	11/12 mm	100 /10000
OL70216	13/14 mm	100 /5000
OL70217	15/16 mm	100 /4000
OL70218	19/20 mm	100 /3000



Nagelclips - Platte Kabel

Attaches à clouer - câble plat



BESTELNUMMER N° DE COMMANDE	ø	
702-0	2 x 0,75	100 /2000
702-1	2 x 1	100 /2000
702-2	2 x 1,5	100 /1000
702-3	2 x 2,5	100 /1000



Plugclips met nagel

Clips cheville avec clou



BESTELNUMMER N° DE COMMANDE	ø	
300620W	16 - 19 mm	200 / 3200
300720W	16 - 19 mm	100 / 1600



SNELMONTAGE FIXATION RAPIDE

Plugclips in PVC - Enkel
Clips cheville en PVC - Simple



BESTELNUMMER N° DE COMMANDE	Ingangen Entrées	∅	
601620	1	16 - 20 mm	200 / 6000
601922	1	19 - 22 mm	125 / 3750
602125	1	21 - 25 mm	125 / 3750

Snelle betonmontage / Fixation beton rapide
Kleur : wit / Couleur : blanc



Plugclips in PVC - Dubbel
Clips cheville en PVC - Double



BESTELNUMMER N° DE COMMANDE	Ingangen Entrées	∅	
611620	2	16 - 20 mm	125 / 3750
611922	2	19 - 22 mm	75 / 2250
612125	2	21 - 25 mm	60 / 1800

Snelle betonmontage / Fixation beton rapide
Kleur : wit / Couleur : blanc



Plugclips in PVC - dubbel
Clips cheville en PVC - Double



BESTELNUMMER N° DE COMMANDE	Ingangen Entrées	∅	
411620	2	16 - 20 mm	120 / 3600

Snelle betonmontage / Fixation beton rapide
Kleur : wit / Couleur : blanc



Pluggen
Chevilles



BESTELNUMMER N° DE COMMANDE	∅	
SEL712006	6 mm	100 / 4000
SEL712008	8 mm	100 / 2500
SEL712010	10 mm	50 / 1250
SEL712012	12 mm	25 / 625

SNELMONTAGE FIXATION RAPIDE

High cavity pluggen - met kraag
Chevilles à haute traction - avec collerette

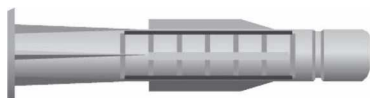

BESTELNUMMER N° DE COMMANDE	∅	
SELRXO101	6 x 35 mm	100 / 1800
SELRXO102	8 x 50 mm	50 / 900

High cavity pluggen / Chevilles à haute traction

Nylon plug voor gipsplaten
Cheville Nylon pour plaques de plâtre



BESTELNUMMER N° DE COMMANDE	∅	
SELGO101	12,3 x 29 mm	100 / 4000

Nylon plug met houtvijs kruis
Cheville Nylon avec visse en croix



BESTELNUMMER N° DE COMMANDE	∅	
SELPXV101	6 x 60 mm	100 / 900

Nylon slagplug kruis
Cheville Nylon à frapper



BESTELNUMMER N° DE COMMANDE	∅	
SELCXP102	5 X 30 mm	100 / 2000
SELCXP104	5 X 40 mm	100 / 2000
SELCXP106	6 x 40 mm	100 / 2000

SNELMONTAGE FIXATION RAPIDE

Verzinkte spreidplug voor gipsplaten
Cheville zinguée pour Gyproc



BESTELNUMMER N° DE COMMANDE	
9401001	200 / 4800

Messing pluggen
Chevilles laiton



BESTELNUMMER N° DE COMMANDE	Afm. Dim.	
BA43-06	M6x8x22mm	1
BA43-08	M8x10x28mm	1
BA43-10	M10x12x32mm	1
BA43-12	M12x15x38mm	1

Kleur pluggen
Chevilles de couleur



BESTELNUMMER N° DE COMMANDE	∅	Kleur	Couleur	
P1ES	5 mm	GEEL	JAUNE	100 / 2000
P2ES	5-5,5 mm	ROOD	ROUGE	100 / 2000
P3ES	7-8 mm	BRUIN	BRUN	100 / 2000

SNELMONTAGE FIXATION RAPIDE

Montagebanden op rol - Recht
Bandes de montage - Droit



BESTELNUMMER N° DE COMMANDE	Afm. Dim.	
250001	12 x 0,7mm	10 / 900
250002	17 x 0,7mm	10 / 600
250005	26 x 1,0 mm	10

Montagebanden op rol - Recht geplastificeerd
Bandes de montage - Droit plastifi e



BESTELNUMMER N° DE COMMANDE	Afm. Dim.	
251001	14 mm	10/ 720
251002	19 mm	10/ 480

Montagebanden - Recht geplastificeerd - Rol in karton
Bandes de montage - Droit Plastifi e - Rouleau en carton



BESTELNUMMER N° DE COMMANDE	Afm. Dim.	
251001C	14 mm	10/ 720
251002C	19 mm	10/ 480

Montagebanden op rol - Rond
Bandes de montage - Rond



BESTELNUMMER N° DE COMMANDE	Afm. Dim.	
350001	12 x 0,7mm	10 / 900*
350002	17 x 0,7mm	10 / 600*

SNELMONTAGE FIXATION RAPIDE

Met Draad
Avec Filetage



BESTELNUMMER N° DE COMMANDE	Afm. Dim.	
501018	M6 x 8 x 18	200 / 3200
501025	M6 x 8 x 25	200 / 3200
501030	M6 x 8 x 30	200 / 3200
501040	M6 x 8 x 40	100 / 2400

Zonder draad
Sans filetage



BESTELNUMMER N° DE COMMANDE	∅	Afm. Dim.	
950418	Kraag/ Col 8 mm	4 x 18 mm	200 / 4800
960418	Kraag/ Col 10 mm	4 x 18 mm	200 / 4800

Drevel
Chasse goujons



BESTELNUMMER N° DE COMMANDE	Afm. Dim.	
10012	M6	1

Drevel met rubber handbeschermer
Chasse goujons avec protection caoutchouc



BESTELNUMMER N° DE COMMANDE	Afm. Dim.	
90HS4	4 mm	1
90HSM6	M6	1
90HSXXX	*	1

* Herstellungsset / Set de réparation

SNELMONTAGE FIXATION RAPIDE

Tacker clips voor vloerverwarming
Tacker clips pour chauffage au sol



BESTELNUMMER N° DE COMMANDE	∅	Lengte Longueur	
TC57	12 - 20 mm	57 mm	1000/ 12000

per lader van 25 ST - Lengte 57mm
par chargeur de 25 PCS - Longueur 57mm

Nietapparaat voor Tacker clips
Pistolet pour Clips Tackers



BESTELNUMMER N° DE COMMANDE	∅	Lengte Longueur	
TCGUN	12 - 20 mm	57 mm	1

Lengte 57mm
Longueur 57mm

RAIL RAIL

Omega-profielen zonder perforatie
 Rails Omega sans perforation



BESTELNUMMER N° DE COMMANDE	Afm. Dim.	Lengte Longueur	
PD35Z	7,5 x 35 mm	2m	40 m
PD35CZ	15 x 35 mm	2m	20 m

Sendzimir verzinkt staal
 Acier galvanisé Sendzimir

Omega-profielen met perforatie
 Rails Omega avec perforation



BESTELNUMMER N° DE COMMANDE	Afm. Dim.	Lengte Longueur	
PD35ZF6	7,5 x 35 mm	2m	40 m
PD35CZF6	15 x 35 mm	2m	20 m
PD15ZF4	15 X 55 mm	2m	100 m
PD32ZF6	15/6 X 32 mm*	2m	20 m

Sendzimir verzinkt staal
 *Asymmetrische
 Acier galvanisé Sendzimir
 *Asymetrique

Snijmachine RAIL
 Machine à couper RAIL



BESTELNUMMER N° DE COMMANDE	Afm. Dim.	Lengte Longueur	
PDTR2M	875 x 130 mm	2m	1

Voor / Pour : PD35Z - PD35CZ - PD35ZF6 - PD35CZF6

Ophangrail
 Rail de suspension



BESTELNUMMER N° DE COMMANDE	Afm. Dim.	Lengte Longueur	
9200900	15 x 30 mm	2m	2/20 m

Sendzimir verzinkt staal/Acier galvanisé Sendzimir
 Lengte/Longueur: 2m



DRAADSTANG TIGE FILETEE

Draadstang verzinkt
Tige filetée galvanisé



BESTELNUMMER N° DE COMMANDE	Afm. Dim.	
TR10006	M6x1000mm	1 / 100
TR10008	M8x1000mm	1 / 50
TR10010	M10x1000mm	1 / 25
TR10012	M12x1000mm	1 / 20
TR20006	M6x2000mm	1 / 50
TR20008	M8x2000mm	1 / 25
TR20010	M10x2000mm	1 / 25
TR20012	M12x2000mm	1 / 20
TR30006	M6x3000mm	1 / 50
TR30008	M8x3000mm	1 / 25
TR30010	M10x3000mm	1 / 25
TR30012	M12x3000mm	1 / 20

DIN 974 4.8

Draadstang INOX
Tige filetée INOX



BESTELNUMMER N° DE COMMANDE	Specificiteit Spécificités	Afm. Dim.	
TR10006INA2	A2	M6x1000mm	1/100
TR10006INA4	A4	M6x1000mm	1/100
TR10008INA2	A2	M8x1000mm	1/100
TR10008INA4	A4	M8x1000mm	1/100
TR10010INA2	A2	M10x1000mm	1/100
TR10012INA2	A2	M12x1000mm	1/100
TR20006INA2	A2	M6x2000mm	1/100
TR20008INA2	A2	M8x2000mm	1/100

DIN 976

* A2 : Inox (304) - Groene Top Markering / Marquage de l'embout Vert

* A4 : Inox (316) - Rode Top Markering / Marquage de l'embout Rouge

Afstandhouders
Entretoises



BESTELNUMMER N° DE COMMANDE	Afm. Dim.	
5720	M6-30 mm	1
5721	M6-50 mm	1
5722	M6-100 mm	1
5725	M8-30 mm	1
5726	M8-50 mm	1
5727	M8-100 mm	1

Galva

DRAADSTANG TIGE FILETEE

Slaganker met plug met draad M8/M10

Cheville à frapper et cheville avec filetage interne M10/M8



BESTELNUMMER N° DE COMMANDE	
9401051	100



Schroefanker met Plug met draad M10/M8

Vis à béton et cheville avec filetage interne M10/M8



BESTELNUMMER N° DE COMMANDE	
9401052	50



Stokvijs

Vis sans tête



BESTELNUMMER N° DE COMMANDE	Afm. Dim.	
HB0050	M8-50 mm	100
HB0060	M8-60 mm	100
HB0070	M8-70 mm	100
HB0080	M8-80 mm	100
HB0100	M8-100 mm	100
HB0120	M8-120 mm	100
HB0150	M8-150 mm	100
HB0180	M8-180 mm	100

Schroef met houtdraad en metrische draadeindje voor M8 beugels

Vis à filetage bois et filetage métrique pour supports M8

FUNCTIE BEHOUD MAINTIENT DE FONCTION

Inslaganker met kraag

Douilles de frappe avec colerette



BESTELNUMMER N° DE COMMANDE	Afm. Dim.	
2014	M8	100
2016	M10	100
2012	M10	100



Keilbout

Boulon expansible





BESTELNUMMER N° DE COMMANDE	Afm. Dim.	RAL	
4570	M8 x32		100

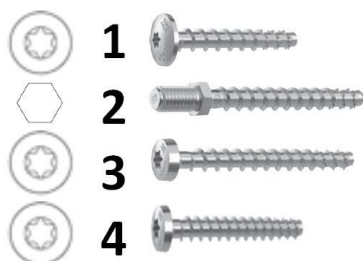

Brandwerend Schroefanker - MMS Plus

Vis à maintien de fonction - MMS Plus



BESTELNUMMER N° DE COMMANDE	Specificiteit Spécificités	Afm. Dim.	
9421	1	MMS-PLUS MS 7.5X40	50
9422	2	MMS-PLUS ST 6.0X55	50
9423	3	MMS-PLUS P 6.0X50	50
9424	4	MMS-PLUS P 6.0X35	50



KABELBINDERS COLLIERS DE CÂBLAGE

Zwart
Noir



BESTELNUMMER N° DE COMMANDE	Afm. Dim.	
SEL3201	75 x 2,5	100 / 5000
SEL3202	100 x 2,5	100 / 5000
SEL3203	135 x 2,5	100 / 5000
SEL3204	160 x 2,5	100 / 5000
SEL3205	200 x 2,5	100 / 5000
SEL3210	140 x 3,5	100 / 5000
SEL3211	200 x 3,5	100 / 5000
SEL3216	250 x 3,5	100 / 5000
SEL3212	280 x 3,5	100 / 5000
SEL3214	360 x 3,5	100 / 4000
SEL3220	140 x 4,5	100 / 5000
SEL3221	160 x 4,5	100 / 5000
SEL3222	180 x 4,5	100 / 5000
SEL3223	200 x 4,5	100 / 5000
SEL3224	250 x 4,5	100 / 5000
SEL3425	280 x 4,5	100 / 5000
SEL3429	300 x 4,5	100 / 4000
SEL3426	360 x 4,5	100 / 4000
SEL3427	380 x 4,5	100 / 3500
SEL3428	430 x 4,5	100 / 2500
SEL3447	360 x 6,0	100 / 1500
SEL3430	180 x 7,5	100 / 2500
SEL3431	240 x 7,5	100 / 2000
SEL3432	200 X 7,5	100 / 5000
SEL3433	280 x 7,5	100 / 2000
SEL3438	320 x 7,5	100 / 1500
SEL3434	360 x 7,5	100 / 1500
SEL2435	450 x 7,5	100 / 2500
SEL3436	500 x 7,5	100 / 1000
SEL3441	750 x 7,5	100 / 700
SEL3144	430 x 9,0	100 / 1000
SEL3142	550 x 9,0	100 / 700
SEL3143	780 x 9,0	100 / 500
SEL3155	1220 x 9,0	100 / 500
SEL3150	250 x 12,5	50 / 500
SEL3451	500 x 12,5	50 / 500
SEL3452	750 x 12,5	50 / 500
SEL3453	1000 x 12,5	50 / 500

Nylon PA 6.6



KABELBINDERS COLLIERS DE CÂBLAGE

Wit
Blanc



BESTELNUMMER N° DE COMMANDE	Afm. Dim.	
SEL2201	75 x 2,5	100 / 5000
SEL2202	100 x 2,5	100 / 5000
SEL2203	135 x 2,5	100 / 5000
SEL2204	160 x 2,5	100 / 5000
SEL2205	200 x 2,5	100 / 5000
SEL2210	140 x 3,5	100 / 5000
SEL2211	200 x 3,5	100 / 5000
SEL3215	225 x 3,5	100 / 5000
SEL2216	250 x 3,5	100 / 5000
SEL2212	280 x 3,5	100 / 5000
SEL2214	360 x 3,5	100 / 4000
SEL2220	140 x 4,5	100 / 5000
SEL2221	160 x 4,5	100 / 5000
SEL2222	180 x 4,5	100 / 5000
SEL2223	200 x 4,5	100 / 5000
SEL2224	250 x 4,5	100 / 5000
SEL2425	280 x 4,5	100 / 5000
SEL2429	300 x 4,5	100 / 4000
SEL2426	360 x 4,5	100 / 4000
SEL2427	380 x 4,5	100 / 3500
SEL2428	430 x 4,5	100 / 2500
SEL2447	360 X 6,0	50 / 500
SEL2430	180 x 7,5	100 / 2500
SEL2432	200 x 7,5	100 / 5000
SEL2431	240 x 7,5	100 / 2000
SEL2433	280 x 7,5	100 / 2000
SEL2438	320 x 7,5	100 / 1500
SEL2434	360 x 7,5	100 / 1500
SEL2435	450 x 7,5	100 / 2500
SEL2436	500 x 7,5	100 / 1000
SEL3437	540 x 7,5	100 / 2500
SEL2441	750 x 7,5	100 / 700
SEL2144	430 x 9,0	100 / 1000
SEL2142	550 x 9,0	100 / 700
SEL2143	780 x 9,0	100 / 500
SEL2155	1220 x 9,0	100 / 500
SEL2450	250 x 12,5	50 / 500
SEL2451	500 x 12,5	50 / 500
SEL2452	750 x 12,5	50 / 500
SEL2453	1000 x 12,5	50 / 500

Nylon PA 6.6



KABELBINDERS COLLIERS DE CÂBLAGE

Kabelbinders gekleurd

Colliers de câblage colorés



BESTELNUMMER N° DE COMMANDE	Afm. Dim.	Kleur	Couleur	
SEL10202R	100 x 2,5	Rood	Rouge	100 / 5000
SEL10210R	140 x 3,5	Rood	Rouge	100 / 5000
SEL10223R	200 x 4,5	Rood	Rouge	100 / 5000
SEL10425R	280 x 4,5	Rood	Rouge	100 / 5000
SEL11202R	100 x 2,5	Blauw	Bleu	100 / 5000
SEL11210R	140 x 3,5	Blauw	Bleu	100 / 5000
SEL11223R	200 x 4,5	Blauw	Bleu	100 / 5000
SEL11425R	280 x 4,5	Blauw	Bleu	100 / 5000
SEL12202R	100 x 2,5	Groen	Vert	100 / 5000
SEL12210R	140 x 3,5	Groen	Vert	100 / 5000
SEL12223R	200 x 4,5	Groen	Vert	100 / 5000
SEL12425R	280 x 4,5	Groen	Vert	100 / 5000
SEL14202R	100 x 2,5	Geel	Jaune	100 / 5000
SEL14210R	140 x 3,5	Geel	Jaune	100 / 5000
SEL14223R	200 x 4,5	Geel	Jaune	100 / 5000
SEL14425R	280 x 4,5	Geel	Jaune	100 / 5000

Rood / Rouge RAL 3000

Blauw / Bleu RAL 5002

Groen / Vert RAL 6024

Geel / Jaune RAL 1201

Nylon PA 6.6



Kabelstrip wit - met markeerplaat 8 x 25 mm

Collier blanc - avec plaquette d'identification 8 x 25 mm



BESTELNUMMER N° DE COMMANDE	Afm. Dim.	
SEL.2.202T	100 x 2,5	100 / 5000

Nylon PA 6.6



KABELBINDERS COLLIERS DE CÂBLAGE

Centuring Polyamide 12

Centuring Polyamide 12



BESTELNUMMER N° DE COMMANDE	Afm. Dim.	
SEL3320	180 x 9	100 / 3500
SEL3321	265 x 9	100 / 2000
SEL3322	360 x 9	100 / 1400
SEL3323	500 x 9	100 / 1000
SEL3324	750 x 9	100 / 1000



Spantang voor Centuring

Pince à sertir pour Centuring



BESTELNUMMER N° DE COMMANDE	∅	
PIN005	∅	1

Maximale breedte 9 mm
Largeur maximale 9 mm

Inox kabelbinders

Colliers de câblage en Inox



BESTELNUMMER N° DE COMMANDE	Afm. Dim.	
SSCT1	150x4.6	100
SSCT2	200x4.6	100
SSCT3	360x4.6	100
SSCT4	520x4.6	100
SSCT5	360x7.9	100
SSCT6	300x4.6	100
SSCT7	520x7.9	100

Plastic coating voor extra randbescherming.
Coating en plastic pour protection supplémentaire des côtés.
UV resistant, low smoke & HF.

KABELBINDERS COLLIERS DE CÂBLAGE

Spantangen
Pinces à sertir



BESTELNUMMER N° DE COMMANDE	Specificiteit Spécificités	
PIN003-CTTN	*1	1
PIN006-CTTS	*2	1

*1

Tang in metaal - Spantang tot 4,8 mm voor nylon - Snijdt zonder braam.

Pince en métal - Pince à serrage pour nylon jusqu'à 4,8 mm - Coupe sans morfil.

*2

Tang in metaal. Spantang tot 7,9 mm voor metalen kabelbinders - Snijdt zonder braam.

Pince en métal - Pince à serrage pour colliers en métal jusqu'à 7,9 mm - Coupe sans morfil.

Nylon binders met Inox tand - naturel
Colliers en nylon avec dent en acier Inox - naturel



BESTELNUMMER N° DE COMMANDE	Afm. Dim.	
MET22102R	100 x 2,5	100
MET22105R	200 x 2,5	100
MET22110R	140 x 3,5	100
MET22111R	200 x 3,5	100
MET22112R	280 x 3,5	100
MET22123R	200 x 4,5	100
MET22126R	360 x 4,5	100
MET22140R	290 x 4,5	100
MET22534R	360 x 7,5	100



Nylon binders met Inox tand - zwart
Colliers en nylon avec dent en acier Inox - noir



BESTELNUMMER N° DE COMMANDE	Afm. Dim.	
MET32102R	100 x 2,5	100
MET32105R	200 x 2,5	100
MET32110R	140 x 3,5	100
MET32111R	200 x 3,5	100
MET32112R	280 x 3,5	100
MET32123R	200 x 4,5	100
MET32126R	360 x 4,5	100
MET32326R	360 X 4,5	100
MET32140R	290 x 4,5	100



KABELBINDERS COLLIERS DE CÂBLAGE

Nylon binders met Inox tand - zwart
Colliers en nylon avec dent en acier Inox - noir



BESTELNUMMER N° DE COMMANDE	Afm. Dim.	
MET32534R	360 x 7,5	50



Click Tie - herbruikbaar - Rood
Click Tie - réouvrable et réutilisable - Rouge



BESTELNUMMER N° DE COMMANDE	Afm. Dim.	
CLT102110R	120 x 3,5	100 / 5000
CLT102116R	240 x 3,8	100 / 5000
CLT102129R	320 x 4,4	100 / 5000
CLT102149R	500 x 5,6	100 / 5000



Plug voor kabelbinders M8
Cheville pour colliers de serrage M8



BESTELNUMMER N° DE COMMANDE	
MF111	100 / 3500

Plug voor kabelbinders tot 9 mm breed.
Cheville pour collier de serrage jusqu'à 9 mm de largeur.



Basis zwart voor kabelbinders
Base noir pour colliers de serrage



BESTELNUMMER N° DE COMMANDE	
MF112	100 / 9600

Plug voor kabelbinders tot 9 mm breed
Cheville pour colliers de serrage jusqu'à 9 mm de largeur
Nylon PA 6.6



KABELBINDERS COLLIERS DE CÂBLAGE

Zelfklevende 2-weg consoles
Consoles adhésives double direction



BESTELNUMMER N° DE COMMANDE	Afm. Dim.	
SEL2501	ø 20 mm	100 / 3000
SEL2502	ø 28 mm	100 / 3000



Identificatieplaatje
Plaquette d'identification



BESTELNUMMER N° DE COMMANDE	Afm. Dim.	
SEL101	20x40x1,3mm	100 / 3000



Klipconsoles 'Hooks' zelfklevend
Consoles clips 'Hooks' adhésives



BESTELNUMMER N° DE COMMANDE	Afm. Dim.	
SEL2401	10 x 19	100 / 3000
SEL2402	13 x 26	100 / 3000
SEL2403	18 x 26	100 / 3000



KABELSCHOENEN SOULIERS DE CABLE

Niet geïsoleerde kabelschoenen

Souliers de câbles non isolés



Vertind / Etamé

Geleidbaarheid / Conductivité : 99,9 % IACS BS 6017 - BS 1977

REMARQUE : Quand un câble souple est utilisé, il est nécessaire de sélectionner la dimension suivante plus grande.

Dimension en mm² du câble : le nombre du n° de commande avant le / : p.e. D035/10.

OPMERKING : Wanneer soepele kabels gebruikt worden, is het noodzakelijk de volgende grotere maat van kabelschoen te selecteren.

Afmeting in mm² van de kabel : het getal van het bestelnummer voor de / : bv. D035/10.

BESTELNUMMER N° DE COMMANDE	Ø
D006/05	5,2 mm
D006/06	6,5 mm
D006/08	8,4 mm
D010/05	5,2 mm
D010/06	6,5 mm
D010/08	8,4 mm
D010/10	10,5 mm
D016/05	5,2 mm
D016/06	6,5 mm
D016/08	8,4 mm
D016/10	10,5 mm
D025/06	6,5 mm
D025/08	8,4 mm
D025/10	10,5 mm
D035/06	6,5 mm
D035/08	8,4 mm
D035/10	10,5 mm
D035/12	13 mm
D050/06	6,5 mm
D050/08	8,4 mm
D050/10	10,5 mm
D050/12	13 mm
D070/08	8,4 mm
D070/10	10,5 mm
D070/12	13 mm
D070/14	15 mm
D095/08	8,4 mm
D095/10	10,5 mm
D095/12	13 mm
D095/14	15 mm
D120/10	10,5 mm
D120/12	13 mm
D120/14	15 mm
D150/08	8,4 mm
D150/10	10,5 mm
D150/12	13 mm
D150/14	15 mm
D185/10	10,5 mm
D185/12	13 mm
D185/14	15 mm
D240/12	13 mm
D240/14	15 mm
D240/16	17 mm

KABELSCHOENEN SOULIERS DE CABLE

Doorverbinders

Raccords



Afmeting in mm² van de kabel/Dimensions en mm² du câble :

- 2,5 mm² voor DB02
- het getal na DB.. in het bestelnummer/le nombre après DB

BESTELNUMMER N° DE COMMANDE	ø IN	Afm. Dim.
DB02	ø 2,4 mm	1,5 mm ²
DB04	ø 4 mm	2,5 mm ²
DB06	ø 3,8 mm	06 mm ²
DB10	ø 4,5 mm	10 mm ²
DB16	ø 5,4 mm	16 mm ²
DB25	ø 6,8 mm	25 mm ²
DB35	ø 8,2 mm	35 mm ²
DB50	ø 9,5 mm	50 mm ²
DB70	ø 11,2 mm	70 mm ²
DB95	ø 13,5 mm	95 mm ²
DB120	ø 15 mm	120 mm ²
DB150	ø 16,5 mm	150 mm ²
DB185	ø 18,5 mm	185 mm ²
DB240	ø 21 mm	240 mm ²

KABELSCHOENEN SOULIERS DE CABLE

Geïsoleerde kabelschoenen 0,5 à 1,5 mm²

Souliers de câbles isolés 0,5 à 1,5 mm²



DVR



DVF



DVPO/M



DVPO/F



DVFPO



DVABF



DVFPOA



DVBC



DVABM



DVP

De geïsoleerde kabelschoenen zijn in koper en messing met hoge conductiviteit, vertind voor een verhoogde weerstand tegen corrosie.

Les cosses préisolées sont en cuivre et laiton de haute conductivité, étamés pour résistance à la corrosion.

Verpakking / emballage : 100 / 1000

BESTELNUMMER N° DE COMMANDE	Omschrijving	Description	ø
DVR1/03	Ring	Ring	3,2
DVR1/03.7	Ring	Ring	3,7
DVR1/04	Ring	Ring	4,3
DVR1/05	Ring	Ring	5,3
DVR1/06	Ring	Ring	6,4
DVR1/08	Ring	Ring	8,4
DVR1/10	Ring	Ring	10,5
DVR1/12	Ring	Ring	13
DVF1/03	Vork	Fourchette	3,2
DVF1/03.7	Vork	Fourchette	3,7
DVF1/04	Vork	Fourchette	4,3
DVF1/05	Vork	Fourchette	5,3
DVF1/06	Vork	Fourchette	6,4
DVPO1/4.8M	Doorverb. Mannelijk	Raccord mâle	-
DVPO1/6.3M	Doorverb. Mannelijk	Raccord mâle	-
DVPO1/2.8F	Doorverb. vrouwelijk	Raccord fémelle	
DVPO1/4.8F	Doorverb. vrouwelijk	Raccord fémelle	
DVPO1/6.3F	Doorverb. vrouwelijk	Raccord fémelle	
DVFPO1/4.8F	Vrouwelijk geheel geïsoleerd	Fémelle complète isolé	
DVFPO1/6.3F	Vrouwelijk geheel geïsoleerd	Fémelle complète isolé	
DVFPO1/2.8F	Vrouwelijk geheel geïsoleerd	Fémelle complète isolé	
DVPOA1/6.3	Mannelijk + vrouwelijk	Mâle + fémelle	
DVAB1M	Rond mannelijk	Mâle rond	
DVAB1F	Rond vrouwelijk	Fémelle rond	
DVBC1	Doorverb.	Raccord	
DVP1/09	Pin	Embout	9
DVP1/12	Pin	Embout	12

KABELSCHOENEN SOULIERS DE CABLE

Geïsoleerde kabelschoenen 1,5 à 2,5 mm²

Souliers de câbles isolés 1,5 à 2,5 mm²



DVR



DVF



DVPO/M



DVPO/F



DVFPO



DVFPOA



DVABM



DVABF



DVBC



DVP

De geïsoleerde kabelschoenen zijn in koper en messing met hoge conductiviteit, vertind voor een verhoogde weerstand tegen corrosie.

Les cosses préisolées sont en cuivre et laiton de haute conductivité, étamés pour résistance à la corrosion.

Emb./Verp. : 100/1000

BESTELNUMMER N° DE COMMANDE	Omschrijving	Description	ø
DVR2/03	Ring	Plage oeil	3,2 mm
DVR2/03.7	Ring	Plage oeil	3,7 mm
DVR2/04	Ring	Plage oeil	4,3 mm
DVR2/05	Ring	Plage oeil	5,3 mm
DVR2/06	Ring	Plage oeil	6,4 mm
DVR2/08	Ring	Plage oeil	8,4 mm
DVR2/10	Ring	Plage oeil	10,5 mm
DVR2/12	Ring	Plage oeil	13 mm
DVF2/03	Vork	Fourchette	3,2 mm
DVF2/03.7	Vork	Fourchette	3,7 mm
DVF2/04	Vork	Fourchette	4,3 mm
DVF2/05	Vork	Fourchette	5,3 mm
DVF2/06	Vork	Fourchette	6,4 mm
DVPO2/6.3M	Doorverb. mannelijk	Raccord mâle	
DVPO2/2.8F	Doorverb. vrouwelijk	Raccord femelle	
DVPO2/4.8F	Doorverb. vrouwelijk	Raccord femelle	
DVPO2/6.3F	Doorverb. vrouwelijk	Raccord femelle	
DVFP02/4.8F	Vrouwelijk geheel geïsoleerd	Fémelle compl. isolé	
DVFP02/6.3F	Vrouwelijk geheel geïsoleerd	Fémelle compl. isolé	
DVPOA2/6.3	Mannelijk + vrouwelijk	Mâle + femelle	
DVAB2M	Rond mannelijk	Mâle rond	
DVAB2F	Rond vrouwelijk	Fémelle rond	
DVBC2	Doorverb.	Raccord	
DVP2/09	Pin	Embout	9
DVP2/12	Pin	Embout	12

KABELSCHOENEN SOULIERS DE CABLE

Geïsoleerde kabelschoenen 4 à 6 mm²

Souliers de câbles isolés 4 à 6 mm²



BESTELNUMMER N° DE COMMANDE	Omschrijving	Description	ø
DVR5/04	Ring	Plage oeil	4,3 mm
DVR5/05	Ring	Plage oeil	5,3 mm
DVR5/06	Ring	Plage oeil	6,4 mm
DVR5/08	Ring	Plage oeil	8,4 mm
DVR5/10	Ring	Plage oeil	10,5 mm
DVR5/12	Ring	Plage oeil	13 mm
DVF5/ 03	Vork	Fourchette	3,7 mm
DVF5/ 04	Vork	Fourchette	4,3 mm
DVF5/05	Vork	Fourchette	5,3 mm
DVF5/06	Vork	Fourchette	6,4 mm
DVF5/08	Vork	Fourchette	8 mm
DVP O 5 /6 .3 M	Doorverb. mannelijk	Raccord mâle	
DVP O 5 /6 .3 F	Doorverb. vrouwelijk	Raccord femelle	
DVP O 5 /9 .5 F	Doorverb. vrouwelijk	Raccord femelle	
DVFP O5 /6.3F	Vrouwelijk geheel geïsoleerd	Fémelle complètement isolé	
DVFP O5 /9.5F	Vrouwelijk geheel geïsoleerd	Fémelle complètement isolé	
DVBC 5	Doorverb.	Raccord	
DVP 5/ 1 4	Pin	Embout	14

De geïsoleerde kabelschoenen zijn in koper en messing met hoge conductiviteit, vertind voor een verhoogde weerstand tegen corrosie.

Les cosses préisolées sont en cuivre et laiton de haute conductivité, étamés pour résistance à la corrosion.

Emb./ Verp. : 100/1000

PVC KANALEN CANAUX PVC

Type G - Grijs

Type G - Gris



BESTELNUMMER N° DE COMMANDE	Breedte x Hoogte Largeur x Hauteur	
G16	25x30 mm	80 m
G23	40x30 mm	48 m
G24	60x30 mm	32 m
G13	25x40 mm	60 m
G8	40x40 mm	40 m
G4	60x40 mm	24 m
G26	80x40 mm	24 m
G27	100x40 mm	16 m
G28	120x40 mm	20 m
G5	40x60 mm	36 m
G9	60x60 mm	24 m
G6	80x60 mm	24 m
G17	100x60 mm	20 m
G10	120x60 mm	16 m
G30	150x60 mm	12 m
G31	200x60 mm	8 m
G50	250x70 mm	8 m
G14	25x80 mm	32 m
G15	40x80 mm	24 m
G11	60x80 mm	24 m
G12	80x80 mm	24 m
G19	100x80 mm	16 m
G32	120x80 mm	16 m
G33	150x80 mm	12 m
G48	200x80 mm	8 m
G35	40x100 mm	16 m
G18	60x100 mm	16 m
G37	100x100 mm	16 m
G38	120x100 mm	8 m
G39	150x100 mm	8 m
G40	200x100 mm	8 m
G43	100x150 mm	8 m

Lengte : 2 meter

Kleur : Grijs RAL 7030

Deksel inbegrepen

Longueur : 2 mètres

Couleur : Gris RAL 7030

Couvercle inclus

LIJST VAN DE TOEBEHOREN - ZIE WWW.GSV.BE

LISTE DES ACCESSOIRES - SUR WWW.GSV.BE

PVC KANALEN CANAUX PVC

Type G - 1,3 m - Grijs

Type G - 1,3 m - Gris



BESTELNUMMER N° DE COMMANDE	Breedte x Hoogte Largeur x Hauteur	
G4EK	60x40 mm	15,6 m
G17EK	100x60 mm	13 m
G31EK	200x60 mm	5,2 m
G40EK	200x100 mm	5,2 m
G50EK	250x70 mm	5,2 m

Lengte : 1,3 meter

Kleur : Grijs RAL 7030

Deksel inbegrepen

Longueur : 1,3 mètres

Couleur : Gris RAL 7030

Couvercle inclus

LIJST VAN DE TOEBEHOREN - ZIE WWW.GSV.BE

LISTE DES ACCESSOIRES - SUR WWW.GSV.BE

OP AANVRAAG / SUR DEMANDE

Type G - Wit

Type G - Blanc



BESTELNUMMER N° DE COMMANDE	Breedte x Hoogte Largeur x Hauteur	
G16BEU	25x30 mm	80 m
G23BEU	40x30 mm	48 m
G8BEU	40x40 mm	40 m
G4BEU	60x40 mm	24 m
G27BEU	100x40 mm	16 m
G9BEU	60x60 mm	24 m
G6BEU	80x60 mm	24 m
G17BEU	100x60 mm	20 m
G10BEU	120x60 mm	16 m
G30BEU	150x60 mm	12 m
G31BEU	200x60 mm	8 m
G50BEU	250x70 mm	8 m
G19BEU	100x80 mm	16 m
G33BEU	150x80 mm	12 m
G48BEU	200x80 mm	8 m
G40BEU	200x100 mm	8 m

Lengte : 2 meter Kleur : Wit RAL 9010

Deksel inbegrepen

Longueur : 2 mètres

Couleur : Blanc RAL 9010

Couvercle inclus

LIJST VAN DE TOEBEHOREN - ZIE WWW.GSV.BE

LISTE DES ACCESSOIRES - SUR WWW.GSV.BE

PVC KANALEN CANAUX PVC

Type G - 1,3 m - Wit
Type G - 1,3 m - Blanc



BESTELNUMMER N° DE COMMANDE	Breedte x Hoogte Largeur x Hauteur	
G17EKBEU	100x60 mm	13 m
G31EKBEU	200x60 mm	5,2 m
G40EKBEU	200x100 mm	5,2 m
G50EKBEU	250x70 mm	5,2 m

Lengte : 1,3 meter
Kleur : Wit RAL 9010
Compleet met deksel
Longueur : 1,3 mètres
Couleur : Blanc RAL 9010
Complet avec couvercle
LIJST VAN DE TOEBEHOREN - ZIE WWW.GSV.BE
LISTE DES ACCESSOIRES - SUR WWW.GSV.BE
*OP AANVRAAG - SUR DEMANDE

Type G - 1,5 m - Wit
Type G - 1,5 m - Blanc



BESTELNUMMER N° DE COMMANDE	Breedte x Hoogte Largeur x Hauteur	
G31KBEU	200x60 mm	6 m
G50KBEU	250x70 mm	6 m

Lengte : 1,5 meter
Kleur : Wit RAL 9010
Compleet met deksel
Longueur : 1,5 mètres
Couleur : Blanc RAL 9010
Complet avec couvercle
LIJST VAN DE TOEBEHOREN - ZIE WWW.GSV.BE
LISTE DES ACCESSOIRES - SUR WWW.GSV.BE

Type E - 12-8 mm
Type E - 12-8 mm



BESTELNUMMER N° DE COMMANDE	Breedte x Hoogte Largeur x Hauteur	
E20	15 x 17 mm	120 m
E22	15 x 30 mm	80 m
E16	25 x 30 mm	80 m
E23	40 x 30 mm	48 m
E24	60 x 30 mm	32 m
E25	15 x 40 mm	72 m
E13	25 x 40 mm	60 m
E8	40 x 40 mm	40 m
E4	60 x 40 mm	24 m

Lengte : 2 meter
Kleur : Grijs RAL 7030
Deksel inbegrepen
Longueur : 2 mètres
Couleur : Gris RAL 7030
Couvercle inclus

PVC KANALEN CANAUX PVC

Type E - 12-8 mm

Type E - 12-8 mm

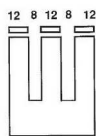

BESTELNUMMER N° DE COMMANDE	Breedte x Hoogte Largeur x Hauteur	
E26	80 x 40 mm	24 m
E27	100 x 40 mm	16 m
E28	120 x 40 mm	16 m
E7	25 x 60 mm	40 m
E5	40 x 60 mm	36 m
E9	60 x 60 mm	24 m
E6	80 x 60 mm	24 m
E17	100 x 60 mm	20 m
E10	120 x 60 mm	16 m
E30	150 x 60 mm	12 m
E31	200 x 60 mm	8 m
E14	25 x 80 mm	32 m
E15	40 x 80 mm	24 m
E11	60 x 80 mm	24 m
E12	80 x 80 mm	24 m
E19	100 x 80 mm	16 m
E32	120 x 80 mm	16 m
E33	150 x 80 mm	12 m
E48	200 x 80 mm	8 m
E34	25 x 100 mm	24 m
E35	40 x 100 mm	16 m
E18	60 x 100 mm	16 m
E36	80 x 100 mm	16 m
E37	100 x 100 mm	16 m
E38	120 x 100 mm	8 m
E39	150 x 100 mm	8 m
E40	200 x 100 mm	8 m
E43	100 x 150 mm	8 m

Lengte : 2 meter
 Kleur : Grijs RAL 7030
 Deksel inbegrepen
 Longueur : 2 mètres
 Couleur : Gris RAL 7030
 Couvercle inclus

PVC KANALEN CANAUX PVC

Type E - DIN - 7,5-5 mm

Type E - DIN - 7,5-5 mm

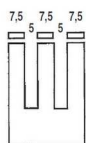

BESTELNUMMER N° DE COMMANDE	Breedte x Hoogte Largeur x Hauteur	
ED2525	25 x 25 mm	84 m
ED2537	25 x 37,5 mm	64 m
ED3737	37,5 x 37,5 mm	48 m
ED2550	25 x 50 mm	52 m
ED3750	37,5 x 50 mm	32 m
ED5050	50 x 50 mm	24 m
ED7550	75 x 50 mm	24 m
ED10050	100 x 50 mm	16 m
ED2575	25 x 75 mm	32 m
ED3775	37,5 x 75 mm	32 m
ED5075	50 x 75 mm	24 m
ED7575	75 x 75 mm	16 m
ED10075	100 x 75 mm	16 m
ED12575	125 x 75 mm	12 m

Lengte/Longueur : 2 m

Kleur/Couleur : Grijs/Gris RAL 7030

Deksel inbegrepen/ Couvercle Inclus

OP AANVRAAG / SUR DEMANDE

Verkrijgbaar in halogeenvrije uitvoering.

Disponible en version sans halogène.

Type E - 6-4 mm

Type E - 6-4 mm

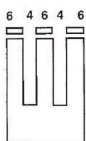

BESTELNUMMER N° DE COMMANDE	Breedte x Hoogte Largeur x Hauteur	
E164	25 x 30 mm	80 m
E134	25 x 40 mm	60 m
E84	40 x 40 mm	40 m
E44	60 x 40 mm	24 m
E264	80 x 40 mm	24 m
E74	25 x 60 mm	40 m
E54	40 x 60 mm	36 m
E94	60 X 60 mm	24 m
E64	80 x 60 mm	24 m
E174	100 x 60 mm	20 m
E104	120 x 60 mm	16 m
E144	25 x 80 mm	32 m
E154	40 x 80 mm	24 m
E114	60 x 80 mm	24 m

Lengte : 2 meter

Kleur : Grijs RAL 7030

Deksel inbegrepen

Longueur : 2 mètres

Couleur : Gris RAL 7030

Couvercle inclus

PVC KANALEN CANAUX PVC

Type E - 6-4 mm

Type E - 6-4 mm

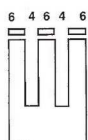

BESTELNUMMER N° DE COMMANDE	Breedte x Hoogte Largeur x Hauteur	
E124	80 x 80 mm	24 m
E194	100 x 80 mm	16 m
E324	120 x 80 mm	16 m
E344	25 x 100 mm	24 m
E354	40 x 100 mm	16 m
E184	60 x 100 mm	16 m
E364	80 x 100 mm	16 m
E374	100 x 100 mm	16 m

Lengte : 2 meter
 Kleur : Grijs RAL 7030
 Deksel inbegrepen
 Longueur : 2 mètres
 Couleur : Gris RAL 7030
 Couvercle inclus

Dwarsclips voor type E

Traverses pour type E



BESTELNUMMER N° DE COMMANDE	Breedte x Hoogte Largeur x Hauteur	
PTR	100 mm	25 / 100
TR06	60 mm	1
TR08	80 mm	1
TR10	100 / 120 mm	1

Klinknagels en Drevel voor dito

Rivets et Chasse pour dito





BESTELNUMMER N° DE COMMANDE	Specificiteit Spécificités	Breedte x Hoogte Largeur x Hauteur	
RIV1	Zwart/ Noir	ø 6,5-7 mm	200
RIV2	Groen/ Vert	ø 4,5-5,5 mm	200
PRRIV1	Tool	RIV1	1
PRRIV2	Tool	RIV2	1

PVC KANALEN CANAUX PVC

Type E - 6-6,5 mm - LSOH

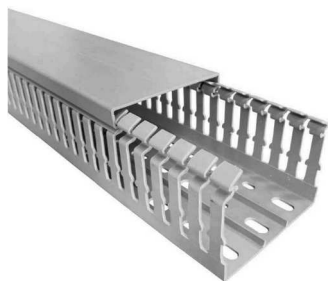
Type E - 6-6,5 mm - LSOH



BESTELNUMMER N° DE COMMANDE	Breedte x Hoogte Largeur x Hauteur	
V6H2525	25 x 25 mm	50
V6H4025	25 x 40 mm	48
V6H4040	40 x 40 mm	50
V6H4060	60 x 40 mm	50
V6H4080	80 x 40 mm	30
V6H6025	25 x 60 mm	60
V6H6040	40 x 60 mm	40
V6H6060	60 x 60 mm	24
V6H6080	80 x 60 mm	20
V6H60100	100 x 60 mm	16
V6H60120	120 X 60 mm	12
V6H8025	25 x 80 mm	20
V6H8040	40 x 80 mm	20
V6H8060	60 x 80 mm	20
V6H8080	80 x 80 mm	12
V6H80100	100 x 80 mm	12
V6H80120	120 x 80 mm	16
V6H10060	60 x 100 mm	16
V6H10080	80 x 100 mm	16
V6H100100	100 x 100 mm	12

Lengte : 2 meter Kleur :
Grijs RAL 7035
Deksel inbegrepen
Longueur : 2 mètres
Couleur : Gris RAL 7035
Couvercle inclus



Kniptang voor bedradingskanalen type E

Pince pour goulottes type E



BESTELNUMMER N° DE COMMANDE	
ECUT	1

PVC KANALEN CANAUX PVC

Snijmachine voor type E

Machine à couper pour goulottes type E



BESTELNUMMER N° DE COMMANDE	
WAB05200	1
ETC120	1

Maximale afmeting : 120 x 120 mm
 Zowel voor PVC als HF
 Dimension maximale : 120 x 120 mm
 Pour PVC comme pour HF

Deksels voor type E en G - Grijs

Couvercles pour type E et G - Gris



BESTELNUMMER N° DE COMMANDE	Breedte x Hoogte Largeur x Hauteur	Lengte Longueur
GCOP025	25 mm	2 m
GCOP040	40 mm	2 m
GCOP060	60 mm	2 m
GCOP080	80 mm	2 m
GCOP100	100 mm	2 m
GCOP120	120 mm	2 m
GCOP150	150 mm	2 m
GCOP200	200 mm	2 m

RAL 7030

Deksels voor type G - Wit

Couvercles pour type G - Blanc



BESTELNUMMER N° DE COMMANDE	Breedte x Hoogte Largeur x Hauteur	Lengte Longueur
GCOP100BEU	100 mm	2 m
GCOP120BEU	120 mm	2 m
GCOP150BEU	150 mm	2 m
GCOP200BEU	200 mm	2 m

RAL 9010

PVC KANALEN CANAUX PVC

Scheidingschotten voor type E en G
Séparations pour type E et G



BESTELNUMMER N° DE COMMANDE	Breedte x Hoogte Largeur x Hauteur	Lengte Longueur	
S1	40 mm	2 m	60 m
S2	60 mm	2 m	50 m

RAL 7030

Kabelhouders voor type E en G
Clips de câble pour type E et G



BESTELNUMMER N° DE COMMANDE	Breedte x Hoogte Largeur x Hauteur	
FCV12040	40/120x40 mm	100
FCV12060	40/200x60 mm	100

Kanalen voor Airco - Wit

Canaux pour Air Conditionné - Blanc



BESTELNUMMER N° DE COMMANDE	Afm. Dim.	
CON30	35 x 30 mm	64 m
CON70	70 x 55 mm	24 m
CON90	90 x 65 mm	16 m
CON125	125 x 75 mm	8 m

UV bestendig Class1

Résistance UV Class1

Deksel inbegrepen

Lengte : 2 meter

Kleur : Wit RAL 9010

Couvercle inclus

Longueur : 2 mètres

Couleur : Blanc RAL 9010

LIJST VAN DE TOEBEHOREN - ZIE WWW.GSV.BE

LISTE DES ACCESSOIRES - SUR WWW.GSV.BE

VLOERKANALEN CANAUX DE SOL

Vloerkanalen
Canaux de sol



BESTELNUMMER N° DE COMMANDE	Afm. Dim.	
ZBFG	75 x 16 mm	40 m
ZBFB	75 x 16 mm	40 m

Lengte / Longueur : 2 m

ZBFG : Couleur/Couleur = grijs/gris

ZBFB : Couleur/Couleur = wit/blanc

*FINAL STOCK

MINIKANALEN MINI GOULOTTE

Zelfklevende mini kanalen
Canaux mini autoadhésifs

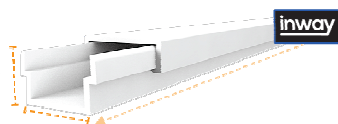

BESTELNUMMER N° DE COMMANDE	Afm. Dim.	
J1207PAD	12 x 7 mm	160 m
J1610PAD	16 x 10 mm	90 m

Met clic-deksel inbegrepen
Lengte : 2 meter
Avec couvercle clic
Longueur : 2 mètres
Wit / Blanc

Minikanalen type BS
Canaux mini type BS



BESTELNUMMER N° DE COMMANDE	Afm. Dim.	
BS11BEU	16 x 16 mm	92 m
BS21BEU	25 x 16 mm	72 m
BS61BEU	60 x 16 mm	36 m

Deksel inbegrepen
Lengte : 2 meter
Couvercle inclus
Longueur : 2 mètres

TYPE G
TYPE G



BESTELNUMMER N° DE COMMANDE	Afm. Dim.	RAL	
G20BEU	15 x 18 mm	RAL 9010	120 m
G41BEU	20 x 10 mm	RAL 9010	120 m
G44BEU	25 x 20 mm	RAL 9010	60 m
G45BEU	40 x 20 mm	RAL 9010	42 m

Deksel inbegrepen
Lengte : 2 meter
Couvercle inclus
Longueur : 2 mètres
Wit - Blanc

MINIKANALEN MINI GOULOTTE

Toebehoren voor mini TYPE G

Accessoires pour MINI TYPE G



BESTELNUMMER N° DE COMMANDE	Omschrijving	Description	Afm. Dim.	
41E	Buitenhoek	Angle Exterieur	20 x 10 mm	10
44E	Buitenhoek	Buitenhoek	25 x 20 mm	5
GT248EB	Buitenhoek	Buitenhoek	40 x 20 mm	5
41I	Binnenhoek	Angle intérieur	20 x 10 mm	10
44I	Binnenhoek	Angle intérieur	25 x 20 mm	5
GT248IB	Binnenhoek	Angle intérieur	40 x 20 mm	5
41L	Vlakke Hoek	Angle Exterieur	20 x 10 mm	10
44L	Vlakke Hoek	Angle Exterieur	25 x 20 mm	5
GT248LB	Vlakke Hoek	Angle Exterieur	40 x 20 mm	5
41T	T Stuk	Dérivation T	20 x 10 mm	10
44T	T Stuk		25 x 20 mm	5
GT248TB	T Stuk	Dérivation T	40 x 20 mm	5
41G	Koppelstuk	Raccord	20 x 10 mm	10
44G	Koppelstuk	Raccord	25 x 20 mm	5
GT248GB	Koppelstuk	Raccord	40 x 20 mm	5
41S	Eindstuk	Embout	20 x 10 mm	10
GT16A	Eindstuk	Embout	25 x 20 mm	5
20BLI	Set voor G20B*	Set pour G20B*	15 x 18 mm	1
GT248AB	Eindstuk	Embout	40 x 20 mm	5

Set : 20BLI = Blisterverpakking met toebehoren voor de G20B met : 1 Buitenhoek + 1 Binnenhoek + 2 Vlakke hoeken + 1 T-stuk + 1 Koppeling + 1 Eindstuk`

Set : 20BLI = Emballage blister avec les accessoires pour la G20B incluant : 1 Angle extérieur + 1 Angle intérieur + 2 Angles plat + 1 Déviation-T + 1 Raccord + 1 Pièce terminale

MINIKANALEN MINI GOULOTTE

TYPE INWAY

TYPE INWAY

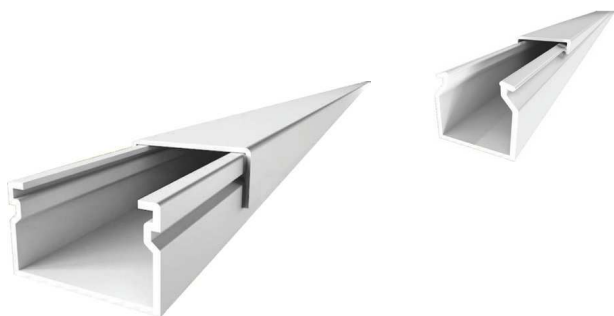

BESTELNUMMER N° DE COMMANDE	Afm. Dim.	RAL	
IW4017B	40 X 17 mm	RAL 9010	32m
IW2010	20 X 10 mm	RAL 9010	80m

Deksel inbegrepen / Couverture inclus
Lengte / Longueur : 2 meter

Mini Inway - Toebehoren

Mini Inway - Accessoires



BESTELNUMMER N° DE COMMANDE	Omschrijving	Description	Afm. Dim.
IWAE2012B	Buitenhoek	Angle extérieur	20 x 12,5 mm
IWAE4017B	Buitenhoek	Angle extérieur	40 x 17 mm
IWAI2012B	Binnenhoek	Angle intérieur	20 x 12,5 mm
IWAI4017B	Binnenhoek	Angle intérieur	40 x 17 mm
IWAP2012B	Vlakke hoek	Angle Plat	20 x 12,5 mm
IWAP4017B	Vlakke hoek	Angle Plat	40 x 17 mm
IWGT2012B	T	Dérivation "T"	20 x 12,5 mm
IWGT4017B	T	Dérivation "T"	40 x 17 mm
IWGU2012B	Koppelstuk	Joint	20 x 12,5 mm
IWGU4017B	Koppelstuk	Joint	40 x 17 mm
IWTT2012B	Eindstuk	Embout	20 x 12,5 mm
IWTT4017B	Eindstuk	Embout	40 x 17 mm



MINIKANALEN MINI GOULOTTE

TYPE INWAY BLACK

TYPE INWAY BLACK



BESTELNUMMER N° DE COMMANDE	Afm. Dim.	RAL	
IW2012.5Black	20 X 12,5 mm	RAL 9005	80 m
IW4017Black	40 x 17 mm	RAL 9005	30 m

Deksel inbegrepen / Couverture inclus
Lengte / Longueur : 2 meter

Mini Inway Black - Toebehoren

Mini Inway Black - Accessoires



BESTELNUMMER N° DE COMMANDE	Omschrijving	Description	Afm. Dim.
IWAE2012Black	Buitenhoek	Angle extérieur	20 x 12,5 mm
IWAE4017Black	Buitenhoek	Angle extérieur	40 x 17 mm
IWAI2012Black	Binnenhoek	Angle intérieur	20 x 12,5 mm
IWAI4017Black	Binnenhoek	Angle intérieur	40 x 17 mm
IWAP2012Black	Vlakke hoek	Angle Plat	20 x 12,5 mm
IWAP4017Black	Vlakke hoek	Angle Plat	40 x 17 mm
IWGT2012Black	"T" stuk	Dérivation "T"	20 x 12,5 mm
IWGT4017Black	"T" stuk	Dérivation "T"	40 x 17 mm
IWGU2012Black	Koppelstuk	Joint	20 x 12,5 mm
IWGU4017Black	Koppelstuk	Joint	40 x 17 mm
IWTT2012Black	Eindstuk	Embout	20 x 12,5 mm
IWTT4017Black	Eindstuk	Embout	40 x 17 mm



MINI KANALEN LSOH GOULOTTES MINI LSOH

TYPE INWAY LSOH

TYPE INWAY LSOH

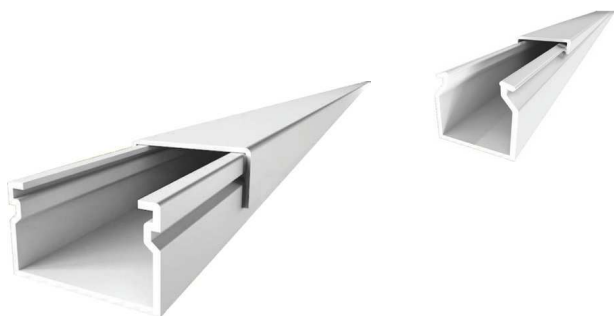

BESTELNUMMER N° DE COMMANDE	Afm. Dim.	RAL	
IW2012.5BLH	20 x 12,5 mm	RAL 9010	80m
IW2020LH	20 x 20 mm	RAL 9010	50m
IW4017LH	40 X 17 mm	RAL 9010	30m
IW4040BLH	40 x 40 mm	RAL 9010	46m
IW6040LH	60 x 40 mm	RAL 9010	32m

Deksel inbegrepen
Lengte : 2 meter
Couvercle inclus
Longueur : 2 mètres



TYPE INWAY BLACK LSOH

TYPE INWAY BLACK LSOH

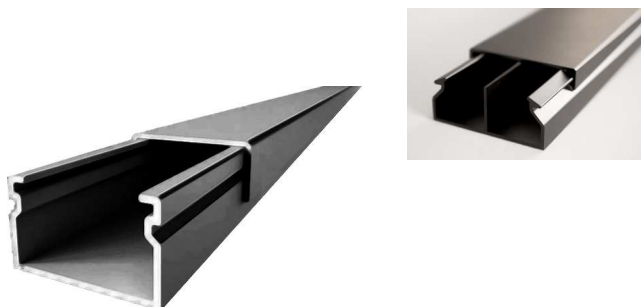

BESTELNUMMER N° DE COMMANDE	Afm. Dim.	RAL	
IW2012.5LHBlack	20 X 12,5 mm	RAL 9005	80 m
IW4017LHBlack	40 x 17 mm	RAL 9005	30 m

Deksel inbegrepen
Lengte : 2 meter
Couvercle inclus
Longueur : 2 mètres



LHD

LHD



BESTELNUMMER N° DE COMMANDE	Afm. Dim.	RAL	
LHD2010HF	20 x 10 mm	RAL 9003	96 m
LHD2020HF	20 x 20 mm	RAL 9003	48 m
LHD4020HF	40 x 20 mm	RAL 9003	24 m
LHD4040HF	40 x 40 mm	RAL 9003	20 m

Deksel inbegrepen
Lengte : 2 meter
Couvercle inclus
Longueur : 2 mètres

LIJST VAN DE TOEBEHOREN - ZIE WWW.GSV.BE
LISTE DES ACCESSOIRES - SUR WWW.GSV.BE



MINI KANALEN LSOH GOULOTTES MINI LSOH

Buitenhoek
Angle extérieur



BESTELNUMMER N° DE COMMANDE	Afm. Dim.	
LHD8926HF	20 x 10 mm	1/10
LHD8626HF	20 x 20 mm	1/10
LHD8636HF	40 x 20 mm	1/10
LHD8646HF	40 x 40 mm	1/10



Binnenhoek
Angle intérieur



BESTELNUMMER N° DE COMMANDE	Afm. Dim.	
LHD8925HF	20 x 10 mm	1/10
LHD8625HF	20 x 20 mm	1/10
LHD8635HF	40 x 20 mm	1/10
LHD8645HF	40 x 40 mm	1/10
SAI160BEU	160 mm	1/10



Vlakke hoek
Angle plat



BESTELNUMMER N° DE COMMANDE	Afm. Dim.	
LHD8923HF	20 x 10 mm	1/10
LHD8623HF	20 x 20 mm	1/10
LHD8633HF	40 x 20 mm	1/10
LHD8643HF	40 x 40 mm	1/10



T-stuk
Déviation-T



BESTELNUMMER N° DE COMMANDE	Afm. Dim.	
LHD8924HF	20 x 10 mm	1/10
LHD8624HF	20 x 20 mm	1/10
LHD8634HF	40 x 20 mm	1/10
LHD8644HF	40 x 40 mm	1/10



WANDKANALEN INWAY GOULOTTES INWAY

Wandkanalen PVC White
Goulotte PVC White

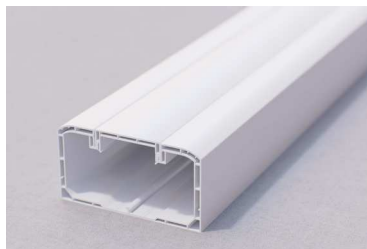

BESTELNUMMER N° DE COMMANDE	Afm. Dim.	Lengte Longueur	
IW10054B	100 x 54 mm	2m	12 m

RAL9003
Deksel inbegrepen
Couvercle inclus

Wandkanalen PVC - Black
Goulotte PVC - Black

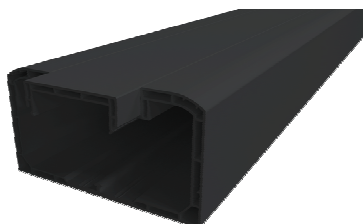

BESTELNUMMER N° DE COMMANDE	Afm. Dim.	Lengte Longueur	
IW10054Black	100 x 54 mm	2m	12 m

RAL9004
Deksel inbegrepen
Couvercle inclus

Wandkanalen LSOH
Goulotte LSOH

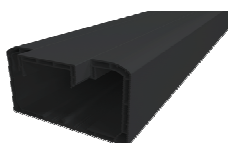
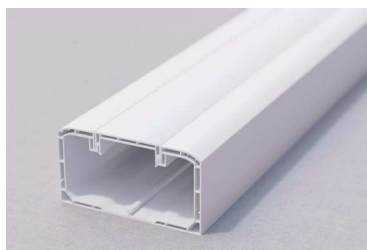

BESTELNUMMER N° DE COMMANDE	Afm. Dim.	RAL	
IW10054BLH	100 x 54 mm	RAL9003	12 m
IW10054LHBLACK	100 x 54 mm	RAL9005	12 m

Deksel inbegrepen
Lengte : 2 meter
Couvercle inclus
Longueur : 2 mètres



WANDKANALEN INWAY GOULOTTES INWAY

Toebehoren Wandkanalen INWAY

Accessoires Goulottes Murales INWAY



BESTELNUMMER N° DE COMMANDE	Omschrijving	Description	
IWAE10054B	Verstelbare buitenhoek	Angle extérieur flexible	6
IWAE10054Black	Verstelbare buitenhoek	Angle extérieur flexible	6
IWAI10054B	Verstelbare binnenhoek	Angle intérieur flexible	6
IWAI10054Black	Verstelbare binnenhoek	Angle intérieur flexible	6
IWAP10054B	Vlakke hoek	Angle plat	8
IWAP10054Black	Vlakke hoek	Angle plat	8
IWGT10054B	T-stuk	Déviation-T	6
IWGT10054Black	T-stuk	Déviation-T	6
IWGUB100	Verbinding voor basis en deksel	Joint pour base et couvercle	100
IWGUB100Black	Verbinding voor basis en deksel	Joint pour base et couvercle	100
IWS10040B	Scheidings	Séparateur	8
IWS10040Black	Scheidings	Séparateur	8
IWTT10054B	Eindstuk	Embout	12
IWTT10054Black	Eindstuk	Embout	12



WANDKANALEN GOULOTTES MURALES

Wandkanaal SYS45 RAPID

Goulottes SYS45 RAPID



BESTELNUMMER N° DE COMMANDE	Afm. Dim.	RAL	
SYS751	75 x 50 mm	RAL 9010	24 m
SYS1252	125 x 50 mm	RAL 9010	16 m
SYS1603	160 x 50 mm	RAL 9010	12 m
SYS10051	100 x 50 mm	RAL 9010	16 m

Deksel inbegrepen

Lengte : 2 meter

Couvercle inclus

Longueur : 2 mètres

LIJST VAN DE TOEBEHOREN - ZIE WWW.GSV.BE

LISTE DES ACCESSOIRES - SUR WWW.GSV.BE

Deksels voor wandkanalen SYS45 RAPID

Couvercles pour goulottes SYS45 RAPID



BESTELNUMMER N° DE COMMANDE	Afm. Dim.	RAL	
SCO45	45 mm	RAL 9010	64 m

Lengte / Longueur : 2 mètres

Verbindingsstuk basis

Joint de fond



BESTELNUMMER N° DE COMMANDE	
SGACBEU	1/50

WANDKANALEN GOULOTTES MURALES

Dekselverbinder
Joint de couvercle



BESTELNUMMER N° DE COMMANDE	
SGCOBEU	1/20

Koppel stuk
Joint

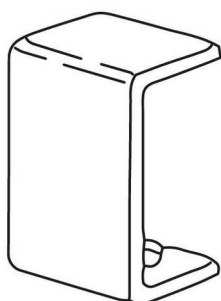

BESTELNUMMER N° DE COMMANDE	Afm. Dim.	
LD125A	125 X 50mm	30

Koppel stuk SYS45 voor 125 * 50
Joint pour SYS45 125 * 50

Buitenhoek
Angle extérieur



BESTELNUMMER N° DE COMMANDE	Afm. Dim.	
LD075EBEU	75 mm	1/16
LD105EBEU	100 mm	1/15
LD125EBEU	125 mm	1/10
SAE160BEU	160 mm	1/4

Binnenhoek
Angle intérieur



BESTELNUMMER N° DE COMMANDE	Afm. Dim.	
LD075IBEU	75 mm	1/16
LD125IBEU	125 mm	1/10
SAI160BEU	160 mm	1/10

WANDKANALEN GOULOTTES MURALES

Vlakke hoek
Angle plat



BESTELNUMMER N° DE COMMANDE	Afm. Dim.	
LD075LBEU	75 mm	1/20
LD105LBEU	100 mm	1/10
LD125LBEU	125 mm	1/8
SAP160BEU	160 mm	1/10

T-stuk
Déviation-T



BESTELNUMMER N° DE COMMANDE	Afm. Dim.	
LHD8924HF	20 x 10 mm	1/10
LHD8624HF	20 x 20 mm	1/10
LHD8634HF	40 x 20 mm	1/10
LHD8644HF	40 x 40 mm	1/10
LD075TBEU	75 mm	1/12
LD105TBEU	100 mm	1/15
LD125TBEU	125 mm	1/10

Eindstuk
Embout



BESTELNUMMER N° DE COMMANDE	Afm. Dim.	
LD075ABEU	75 mm	1/20
STT125BEU	125 mm	1/10
STT160BEU	160 mm	1/10

KABELGELEIDERS CONDUITS POUR CABLES

Spiralen - Transparant
Spirales - Transparent



BESTELNUMMER N° DE COMMANDE	∅	
CP03	3 mm	50 m
CP06	6 mm	25 m
CP08	8 mm	25 m
CP10	10 mm	25 m
CP12	12 mm	25 m
CP20	20 mm	10 m

Spiralen Zwart
Spirales Noir



BESTELNUMMER N° DE COMMANDE	∅	
CPN03	3 mm	50 m
CPN06	6 mm	25 m
CPN08	8 mm	25 m
CPN10	10 mm	25 m
CPN12	12 mm	25 m
CPN20	20 mm	10 m

Polyester beschermkous
Gaine de protection polyester



BESTELNUMMER N° DE COMMANDE	∅	
Guest05	5-10 mm	200 m
Guest10	10-18 mm	200 m
Guest20	20-30 mm	100 m
Guest30	30-45 mm	100 m
Guest50	50-75 mm	50 m

Mini bedradingskanalen
Canaux de câblage mini

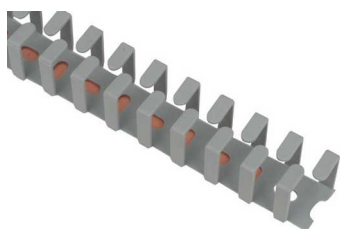

BESTELNUMMER N° DE COMMANDE	Afm. Dim.	
FLX10	13 x 15 mm	25 m
FLX20	20 x 24 mm	25 m
FLX30	29 x 33 mm	25 m
FLX40	40 x 44 mm	25 m

Lengte / longueur : 500 mm

AARDINGSMATERIAAL MATERIEL DE MISE A LA TERRE

Aardstaven kruisvorm met vlag

Piquets de terre en forme de croix avec drapeau



BESTELNUMMER N° DE COMMANDE	Afm. Dim.	Lengte Longueur	
AML511		1,0 m	5
AML512		1,5 m	5
AML513		2,0 m	5
AML514		2,5 m	5
AML515		3,0 m	5
AML512-E	1500 mm*		5

50 x 50 x 3 mm

Warm verzinkt / Galvanisé chaud

* Zonder vlag / Sans drapeau

Klemschroeven voor aardstaaf

Boulons de serrage pour piquet de terre



BESTELNUMMER N° DE COMMANDE	Omschrijving	Description	
AMM1	Enkel	Simple	10
AMM2	Dubbel	Double	10

Bandaardingsklem

Bandes pour mise à la terre



BESTELNUMMER N° DE COMMANDE	Afm. Dim.	
AM370	12 cm	10/300
AM371	19 cm	10/300
AM374	42 cm	10/160
AM376	58 cm	20/200

Voor / Pour : 1 x 2,5 mm² à 2 x 6 mm²

Vernikkelde klem + schroef. Inox band.

Clame + écrous nickelées. Bande en inox.

AARDINGSMATERIAAL MATERIEL DE MISE A LA TERRE

Moerklemmen (Splitklemmen)
Connecteurs de dérivation



BESTELNUMMER N° DE COMMANDE	∅	
AM9200026	6 - 10 mm ²	100
AM9200027	16 mm ²	100
AM9200028	25 mm ²	100
AM9200029	35 mm ²	50
AM9200030	50 mm ²	50

Messing vernikkeld
Laiton nickelé

Aardstaven met kopermantel om te vijzen - 30 μ
Piquets manteau de cuivre pour visser - 30 μ



BESTELNUMMER N° DE COMMANDE	∅ IN	∅	Lengte Longueur	
AM117	14,2 mm	16 mm	1500 mm	10 / 500
AM118	14,2 mm	16 mm	2000 mm	10
AM127	16,0 mm	18 mm	1500 mm	10
AM128	16,0 mm	18 mm	2000 mm	10

Aardstaven met kopermantel om te vijzen - 100 μ
Piquets manteau de cuivre pour visser - 100 μ



BESTELNUMMER N° DE COMMANDE	∅ IN	∅	Lengte Longueur	
AM117-100	14,2 mm	16 mm	1500 mm	10 / 500
AM118-100	14,2 mm	16 mm	2000 mm	10
AM127-100	16,0 mm	18 mm	1500 mm	10
AM128-100	16,0 mm	18 mm	2000 mm	10

Aardstaven met kopermantel om te vijzen - 250 μ
Piquets manteau de cuivre pour visser - 250 μ



BESTELNUMMER N° DE COMMANDE	∅ IN	∅	Lengte Longueur	
AM117-250	14,2 mm	16mm	1500 mm	*
AM118-250	14,2 mm	16mm	2000 mm	*

AARDINGSMATERIAAL MATERIEL DE MISE A LA TERRE

Moffen om te vijzen
Manchons à visser



BESTELNUMMER N° DE COMMANDE	∅	
AMM116	16 mm	1/130
AMM126	18 mm	1/120
AMMB116	16 mm	1/240

Messing / Laiton

Aardstaven met kopermantel conisch - 30 µ
Piquets manteau cuivre conique - 30 µ



BESTELNUMMER N° DE COMMANDE	Specificiteit Spécificités	∅	Lengte Longueur	
AM114SS	30 µm	14,0 mm	1500 mm	10 / 500

Moffen conisch
Manchons cône



BESTELNUMMER N° DE COMMANDE	∅	
AMM116-C	14 mm	1/100

Messing / Laiton

Klemmen
Clames



BESTELNUMMER N° DE COMMANDE	∅	GRONDST	MATIERE	
AMSB116	16 mm	Verkoperd metaal	Acier cuivré	1/250
AMSB126	18 mm	Verkoperd metaal	Acier cuivré	1/100

1 Messing / Laiton

AARDINGSMATERIAAL MATERIEL DE MISE A LA TERRE

Klemmen
Clames



BESTELNUMMER N° DE COMMANDE	∅	GRONDST	MATIERE	
AMS116-2	16 mm	Messing	Laiton	20/300
AMS126	18 mm	Messing	Laiton	1/100
AMS116	16 mm	Messing	Laiton	1/250

1 Messing / Laiton

Handslagijzers
Têtes de frappe



BESTELNUMMER N° DE COMMANDE	Specificiteit Spécificités	∅	
AMT116	*1	16 mm	1/100
AMT126	*1	18 mm	1/100

Handslagbouten
Boulons de frappe



BESTELNUMMER N° DE COMMANDE	∅	
AMDS16	16 mm	1/100
AMDS18	18 mm	1/100

Aardingsonderbrekers
Coupures de terre



BESTELNUMMER N° DE COMMANDE	
AM0301	25

AARDINGSMATERIAAL MATERIEL DE MISE A LA TERRE

Rail
Rail



BESTELNUMMER N° DE COMMANDE	
AM0303	20

Aardingsonderbrekers + rail
Coupures de terre + rail

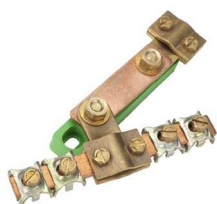

BESTELNUMMER N° DE COMMANDE	
AM0305	14

Hoofdaardrail
Barrette de terre Principale

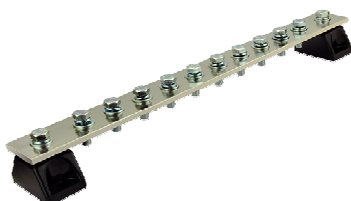

BESTELNUMMER N° DE COMMANDE	A	FASES PHASES	Lengte Longueur
AM0306	200A	10 x M8	400 mm

Koper vernikkeld / Cuivre nickelé



Klauw
Griffe



BESTELNUMMER N° DE COMMANDE	
AMK0310	100

AARDINGSMATERIAAL MATERIEL DE MISE A LA TERRE

Klauwklemmen
Borniers à griffes



BESTELNUMMER N° DE COMMANDE	Specificiteit Spécificités	∅	
AMCC1016	*1	< 16 mm ²	1
AMCC2550	*1	< 50 mm ²	1
AMCC-D-1016	*2	< 16 mm ²	1
AMCC-D-2550	*2	< 50 mm ²	1

*1 Enkel / Simple
*2 Dubbel / Double

Design radiator klemmen
Clame de terre pour écrou de radiateur



BESTELNUMMER N° DE COMMANDE	Afm. Dim.	GRONDST	MATIERE	
AM9260030	30 mm	Messing -Vernikkelc	Laiton Nickelé	5

Stekkers Fiches

C310W
C310B



BESTELNUMMER N° DE COMMANDE	Specificiteit Spécificités	
C310B	Black	1/25
C310W	White	1/25

IP20 - 250V - IEC60884 - DIN49441
10/16 A
Rubber / Caoutchouc

C311W
C311B



BESTELNUMMER N° DE COMMANDE	Specificiteit Spécificités	
C311B	Black	1/24
C311W	White	1/24

IP20 - 250V - IEC60884 - DIN49441
IP20 - 250V - IEC60884 - DIN49441
10/16 A
Rubber / Caoutchouc

C404
C404



BESTELNUMMER N° DE COMMANDE	
C404	1/40

250V - Norm7 - TUV ; 10/16A - IP44

C403
C403



BESTELNUMMER N° DE COMMANDE	
C403	1/50

10/16A₁ IP44
Normes
250V - Norm7 - TUV

Stekkers Fiches

C300W

C300B



BESTELNUMMER N° DE COMMANDE	Specificiteit Spécificités	
C300B	Black	1/25
C300W	White	1/25

IP20 - 250V - IEC60884 - DIN49441
16 A
PVC

Stekker

Fiches plates



BESTELNUMMER N° DE COMMANDE	Specificiteit Spécificités	
C320B	Black	1/48
C320W	White	1/48
C321B	Black	1/48
C321W	White	1/48

320* 321*
Mannelijk Vrouwelijk
Mâle Femelle
PVC
10A - 250V - IEC 60884 - UNE ESC10a

CEE STEKKER - IP44 PRISES CEE - IP44

Stekkers

Fiches mâles



BESTELNUMMER N° DE COMMANDE	A	Polen Poles	Spanning Tension	
9316-4	16 A	3	230 V	10
9416-4	16 A	4	400 V	10
9516-4	16 A	5	400 V	10
9332-4	32 A	3	230 V	10
9432-4	32 A	4	400 V	10
9532-4	32 A	5	400 V	10



Koppelstekkers

Fiches femelles



BESTELNUMMER N° DE COMMANDE	A	Polen Poles	Spanning Tension	
9316-3	16 A	3	230 V	10
9416-3	16 A	4	400 V	10
9516-3	16 A	5	380 V	10
9332-3	32 A	3	230 V	10
9432-3	32 A	4	400 V	10
9532-3	32 A	5	400 V	10



Wanddozen

Prises murales



BESTELNUMMER N° DE COMMANDE	A	Polen Poles	Spanning Tension	
9316-2	16 A	3	230 V	10
9416-2	16 A	4	400 V	5
9516-2	16 A	5	400 V	5
9332-2	32 A	3	230 V	5
9432-2	32 A	4	400 V	5
9532-2	32 A	5	400 V	5



CEE STEKKER - IP44 PRISES CEE - IP44

Inbouwdozen

Prises à encastrer



BESTELNUMMER N° DE COMMANDE	A	Polen Poles	Spanning Tension	
9316-1	16 A	3	230 V	10
9416-1	16 A	4	400 V	10
9516-1	16 A	5	400 V	10
9332-1	32 A	3	230 V	10
9432-1	32 A	4	400 V	10
9532-1	32 A	5	400 V	10

5polen/poles = 3polen/poles + T + N

4polen/poles = 3polen/poles + T

3polen/poles = 2polen/poles + T



CEE STEKKERS - IP67 PRISES CEE - IP67

Stekkers

Fiches mâles



BESTELNUMMER N° DE COMMANDE	A	Polen Poles	Spanning Tension	
679316-4	16 A	3	250 V	10
679416-4	16 A	4	415 V	10
679516-4	16 A	5	415 V	10
679332-4	32 A	3	250 V	10
679432-4	32 A	4	415 V	10
679532-4	32 A	5	415 V	10
679363-8	63 A	3	250 V	1
679463-8	63 A	4	415 V	1
679563-8	63 A	5	415 V	1

IP67



Koppelstekkers

Fiches femelles



BESTELNUMMER N° DE COMMANDE	A	Polen Poles	Spanning Tension	
679316-3	16 A	3	250 V	10
679416-3	16 A	4	415 V	10
679516-3	16 A	5	415 V	10
679332-3	32 A	3	250 V	10
679432-3	32 A	4	415 V	10
679532-3	32 A	5	415 V	10
679363-7	63 A	3	250 V	1
679463-7	63 A	4	415 V	1
679563-7	63 A	5	415 V	1

IP67



Wanddozen

Prises murales



BESTELNUMMER N° DE COMMANDE	A	Polen Poles	Spanning Tension	
679316-2	16 A	3	250 V	10
679416-2	16 A	4	415 V	10
679516-2	16 A	5	415 V	10
679332-2	32 A	3	250 V	10

IP67



CEE STEKKERS - IP67 PRISES CEE - IP67

Wanddozen
Prises murales



BESTELNUMMER N° DE COMMANDE	A	Polen Poles	Spanning Tension	
679432-2	32 A	4	415 V	10
679532-2	32 A	5	415 V	10
679363-6	63 A	3	250 V	1
679463-6	63 A	4	415 V	1
679563-6	63 A	5	415 V	1

IP67



Inbouwdozen
Prises à encastrer



BESTELNUMMER N° DE COMMANDE	A	Polen Poles	Spanning Tension	
679316-1	16 A	3	250 V	10
679416-1	16 A	4	415 V	10
679516-1	16 A	5	415 V	10
679332-1	32 A	3	250 V	10
679432-1	32 A	4	415 V	10
679532-1	32 A	5	415 V	8
679363-5	63 A	3	250 V	2
679463-5	63 A	4	415 V	2
679563-5	63 A	5	415 V	2

IP67

5polen/poles = 3polen/poles + T + N

4polen/poles = 3polen/poles + T

3polen/poles = 2polen/poles + T



VERLENGSNOER EN STOPCONTACTEN ENROULEUR ET PRISES

VERLENGSNOER RUBBER
RALLONGE CAOUTCHOUC



BESTELNUMMER N° DE COMMANDE	Lengte Longueur	
MFVS10	10m	1
MFVS15	15m	1
MFVS20	20m	1
MFVS25	25m	1
MFVS30	30m	1
MFVS40	40m	1
MFVS50	50m	1

H07RN-F, 3G2.5, IP44, 16A, 250V

PROFESSIONELE KABELHASPEL
ENROULEUR PROFESSIONNEL



BESTELNUMMER N° DE COMMANDE	Lengte Longueur	
MFR253G25	25m	1
MFR403G25	40m	1

4 prises/stopcontacten, IP44, H07RN-F, 25m, 3G2.5, 16A, 250V, 3600W

PROFESSIONELE MEERVOUDIGE STEKKERBLOK
SOCLE MULTIPRISES PROFESSIONNEL



BESTELNUMMER N° DE COMMANDE	
MFM46	1

4 prises/stopcontacten, IP44, H07RN-F, 6m, 3G2.5, 16A, 250V

INBOUW STOPCONTACT MET KLAPDEKSEL
PRISE A CLAPET A ENCASTRER

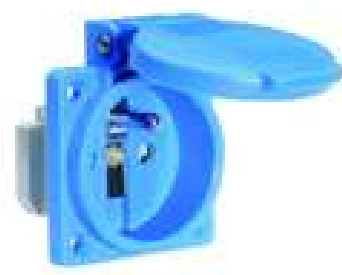

BESTELNUMMER N° DE COMMANDE	
MFPS17	1

blauw, penaaarding, IP44, 16A, 250V
bleu, broche de terre

VERLENGSNOER EN STOPCONTACTEN ENROULEUR ET PRISES

DOOS VOOR STEKKERVERBINDING, IP44
BOÎTIER POUR RACCORD DE PRISES, IP44



BESTELNUMMER
N° DE COMMANDE

MFBOX01



1

CE, RoHS, REACH, PAHS

GEREEDSCHAP OUTILLAGE

W4-16



BESTELNUMMER N° DE COMMANDE	∅	
W4-16	4 - 16 mm ²	1/12

Met haakkling voor verwijdering van de isolatie.
Avec lame spéciale pour écarter l'isolation.

W8-28



BESTELNUMMER N° DE COMMANDE	∅	
W8-27	8 - 28 mm ²	1/12

Met haakkling voor verwijdering van de isolatie.
Avec lame spéciale pour écarter l'isolation.

W50



BESTELNUMMER N° DE COMMANDE	∅ IN	∅	
W50	35 - 50	35 - 50 mm ²	1/12

W1000



BESTELNUMMER N° DE COMMANDE	
W1000	1/12

Met haakkling voor verwijdering van de isolatie.
Avec lame spéciale pour écarter l'isolation.

GEREEDSCHAP OUTILLAGE

WBLI28H4



BESTELNUMMER N° DE COMMANDE	∅	
WBLI28H4	4 - 28 mm	1/12

Met haakkling voor verwijdering van de isolatie.
Avec lame spéciale pour écarter l'isolation.

WBLIS428



BESTELNUMMER N° DE COMMANDE	∅	
WBLIS428	4 - 28 mm	1/12

Gemoderniseerde versie van de BLI28H. Met inklapbaar mes.
Version modernisée du BLI28H. Avec lame retractable,

W10



BESTELNUMMER N° DE COMMANDE	
W10	1

Vervangmesje voor 16 - 27 - 50 - BLI28H
Lame de réchange pour 16 - 27 - 50 - BLI28H

W10.1



BESTELNUMMER N° DE COMMANDE	
W10.1	1

Vervangmesje voor BLIS428
Lame de réchange pour BLIS428

W100



BESTELNUMMER N° DE COMMANDE	
W100	1/12

Ontmantelmes + striptang.
Couteau à démanteler + dénuder.

WBLI13



BESTELNUMMER N° DE COMMANDE	∅	
WBLI13	6 - 13 mm	1/ 12

Ontmantelingsmes ronde kabel van 3 x 1,5 mm tot 5 x 2,5 mm.
Buitendiameter : 6 tot 13 mm.
Couteau à démanteler pour câble ronds de 3 x 1,5 mm² à 5 x 2,5 mm.
Diamètre extérieur : 6 à 13 mm.

W16



BESTELNUMMER N° DE COMMANDE	∅ IN	∅	
W16	4 - 16	8 - 13 mm ²	1/12

Quadro Ontmantelingsmes, haakmes inklapbaar, strippen 0,5 tot 6mm²
Quadro Couteau a demanteler, lame en crochet retractable, dénudeur
0,5 jusqu'au 6mm²

W30



BESTELNUMMER N° DE COMMANDE	∅	
W30	4 - 10 mm	1/12

Data - Strip Ontmantelingsmes voor data kabel, strippen 0,2 - 0,8mm²
Data Strip - Couteau à demanteler pour câble data, coupe-fil jusqu'à ∅ 8 mm, dénudeur 0,2 - 0,8 mm²

GEREEDSCHAP OUTILLAGE

W25



BESTELNUMMER N° DE COMMANDE	∅	
W25	25 mm	1/6

Ontmantelingsmes voor grondkabel, $\varnothing = 25\text{mm}$ (zowel dwars als in de lengte), tot manteldikte 5mm
 Couteau à demanteler pour cable de sol, $\varnothing = 25\text{ mm}$ (circulaire et longitudinal), jusqu'à 5mm d'épaisseur

Striptang SUPER
 Pince à dénuder SUPER



BESTELNUMMER N° DE COMMANDE	∅	
WBL15	0,2-6 mm	1/6

Tang DUO CRIMP
 Pince DUO CRIMP



BESTELNUMMER N° DE COMMANDE	∅	
W300	0,5-6 mm	1/6

MULTI-STRIPPER
 MULTI-STRIPPER



BESTELNUMMER N° DE COMMANDE	∅	
W400	8-13 mm	1/6

GEREEDSCHAP OUTILLAGE

MULTI-STRIPPER PLUS
MULTI-STRIPPER PLUS



BESTELNUMMER N° DE COMMANDE	∅	
W500	0,5-6 mm	1/12

Strippen + knippen + krimpen.
Dénuder + couper +sertir.

Striptangen SOLAR
Pincès à dénuder SOLAR



BESTELNUMMER N° DE COMMANDE	∅	
WBLI3SOLAR	1,5 - 6 mm ²	1
WBLI7SOLAR	1,5 - 6 mm ²	1

Speciaal voor zonne-energietechniek.
Spécialement pour le technique énergie solaire.

Krimptangen voor geïsoleerde kabelschoenen
Pincès à sertir pour souliers de cable isolés



BESTELNUMMER N° DE COMMANDE	∅	
DHCR15	1,5 - 4 mm ²	1

Krimptang voor niet-geïsoleerde kabelschoenen
Pince à sertir pour souliers de cable non-isolés



BESTELNUMMER N° DE COMMANDE	∅	
DHC95	10 - 95 mm ²	1

GEREEDSCHAP OUTILLAGE

Buistang Voor het knippen van PVC-buizen 16 mm en 20 mm
Pince pour couper tubes Pour couper tubes en PVC de 16 mm et



BESTELNUMMER N° DE COMMANDE	
KT3204	1

Voor het knippen van PVC-buizen
16 mm en 20 mm.
Pour couper tubes en PVC de
16 mm et 20 mm.

Reserve onderbasis tang 3204
Base de rechange pour pince 3204



BESTELNUMMER N° DE COMMANDE	
KT3002-3204	1

Reservemesje tangen 3204 en 3704
Lame de rechange pour pinces 3204 et 3704



BESTELNUMMER N° DE COMMANDE	
KT3001	1

Flextang Voorbekabelde Ribbuis
Pince Pour Tube Flex



BESTELNUMMER N° DE COMMANDE	∅	
KT3704	16 - 20 mm (21 mm)	1

Voor ontmanteling van voorbekabelde ribbel-buis.
Pour démanteler tubes annelés pré-câblés.
16 - 20 mm (21 mm)

GEREEDSCHAP OUTILLAGE

Onderbasis Voor Tang 3704

Base Pour Pince 3704



BESTELNUMMER N° DE COMMANDE	
KT3002-3704	1

Reservemesje tangen 3204 en 3704

Lame de rechange pour pinces 3204 et 3704



BESTELNUMMER N° DE COMMANDE	
KT3001	1

Kanaaltang

Pince de canal



BESTELNUMMER N° DE COMMANDE	
KT3604	1

Trekveren Spiraal ø 5,5 mm, versterkt

Tire-fils Spirale ø 5,5 mm, renforcé



BESTELNUMMER N° DE COMMANDE	Lengte Longueur	
305505	5 m	1/20
305510	10 m	1/15
305515	15 m	1/10
305520	20 m	1/8
305525	25 m	1/6
305530	30 m	1/5

GEREEDSCHAP OUTILLAGE

Plat



BESTELNUMMER N° DE COMMANDE	Lengte Longueur	
11405	5 m	1/10
11410	10 m	1/10
11415	15 m	1/10
11420	20 m	1/10
11425	25 m	1/10
11430	30 m	1/10

Nylon dia. 4 mm



BESTELNUMMER N° DE COMMANDE	Lengte Longueur	
11605	5 m	1/25
11610	10 m	1/20
11615	15 m	1/12
11620	20 m	1/10
11625	25 m	1/8
11630	30 m	1/6

Glasfiber
Fibre de verre

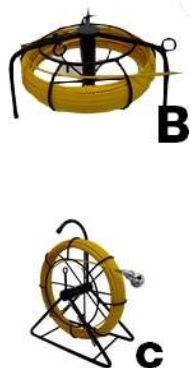

BESTELNUMMER N° DE COMMANDE	ø IN	Lengte Longueur	PIC
37000	3,5 mm	30 m	A
37010	4,5 mm	50 m	A
37020	6 mm	60 m	A
37030	6 mm	80 m	A
37040	6 mm	100 m	A
37050	9 mm	60 m	A
37060	9 mm	100 m	A
37070	9 mm	120 m	A
37080	11 mm	150 m	A
37090	3,5 mm	30 m	B
37100	4,5 mm	50 m	C
37110	6 mm	60 m	C
37120	6 mm	80 m	C
37130	6 mm	100 m	C
37140	9 mm	60 m	C
37150	9 mm	100 m	C

Op bestelling / sur commande



GEREEDSCHAP OUTILLAGE

Glasfiber
Fibre de verre

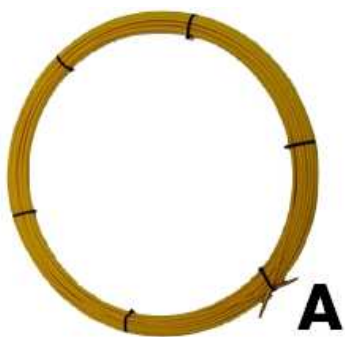

BESTELNUMMER N° DE COMMANDE	ø IN	Lengte Longueur	PIC
37160	9 mm	120 m	C
37170	11 mm	150 m	C

Op bestelling / sur commande



Spirado



BESTELNUMMER N° DE COMMANDE	
Spirado	1

Spiratrek



BESTELNUMMER N° DE COMMANDE	
Spiratrek	1

Buigveren
Ressorts à courber



BESTELNUMMER N° DE COMMANDE	ø	Lengte Longueur	
310816	16 mm	80 cm	1
310820	20 mm	80 cm	1
310825	25 mm	80 cm	1
311616	16 mm	160 cm	1
311620	20 mm	160 cm	1

Versterkte uitvoering.
Staaldraad 2 x 2 mm.
Exécution renforcée.
Fil en acier 2 x 2 mm.

GEREEDSCHAP OUTILLAGE

Buigveren

Ressorts à courber



BESTELNUMMER N° DE COMMANDE	∅	Lengte Longueur	
311625	25 mm	160 cm	1

Versterkte uitvoering.
Staaldraad 2 x 2 mm.
Exécution renforcée.
Fil en acier 2 x 2 mm.

Fitting in thermoplast E27
Soquet thermoplastique E27



BESTELNUMMER N° DE COMMANDE	Kleur	Couleur	
755	Zwart	Noir	50 / 500



Kelderverlichtingen
Hublots



BESTELNUMMER N° DE COMMANDE	Specificiteit Spécificités	VERMOGEN PUISSANCE	
460	1	100 W	1/30
470	2	100 W	1/18
471	3	60 W	1/24

Voet : PVC
Glas : Polycarbonaat / onbreekbaar.
Pied : PVC
Verre : Polycarbonate / incassable



BEUGELS MET RUBBER COLLIERS ISOPHONIQUES

Met Scharnier
Avec Charnière



BESTELNUMMER N° DE COMMANDE	∅	
PC0015	11-15 mm	100
PC0018	15-19 mm	100
PC0022	21-23 mm	100
PC0028	26-28 mm	100
PC0035	32-35 mm	100
PC0042	40-43 mm	50
PC0048	48-51 mm	50
PC0054	51-56 mm	50
PC0060	57-60 mm	50
PC0064	62-65 mm	50
PC1075	75-80 mm	25
PC0090	87-92 mm	25
PC0110	107-112 mm	25

Snelmontage met rubber
Fixation rapide avec caoutchouc

Met twee vijzen
Avec deux vis



BESTELNUMMER N° DE COMMANDE	∅	
PC1100	99-105 mm	25
PC1115	113-118 mm	25
PC1125	125-130 mm	25
PC1133	132-137 mm	25
PC1140	138-142 mm	25
PC1150	148-152 mm	25
PC1160	159-166 mm	25

METALEN KANALEN CHEMINS DE CÂBLE EN METAL

Metalen kanalen geperforeerd
Chemins de câble perforés



BESTELNUMMER N° DE COMMANDE	Afm. Dim.	
MT6075075	60x75x0,75mm	24 m
MT60100075	60x100x0,75mm	18 m
MT60200075	60x200x0,75mm	18 m
MT60300075	60x300x0,75mm	12 m

LIJST VAN DE TOEBEHOREN - ZIE WWW.GSV.BE
LISTE DES ACCESSOIRES - SUR WWW.GSV.BE
Lengte/Longueur : 3 m

C - Beugel voor plafond
Fixation en C pour plafond

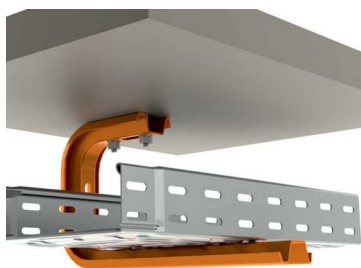

BESTELNUMMER N° DE COMMANDE	Afm. Dim.	
MTCTS100	161 x 172 mm	12
MTCTS200	261 x 172 mm	12
MTCTS300	361 x 172 mm	6

L - beugel voor Wand
Fixation en L Murale



BESTELNUMMER N° DE COMMANDE	Afm. Dim.	
MTLTS100	145 x 150 mm	20
MTLTS150	195 x 150 mm	20
MTLTS200	245 x 150 mm	20
MTLTS300	345 x 150 mm	20

Draadgoten Easy Connect - EZ
Chemins de câble Easy Connect - EZ

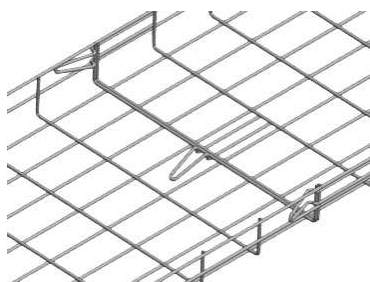

BESTELNUMMER N° DE COMMANDE	Afm. Dim.	
EC60060EZ	60x060mm	36 / 1008 m
EC60100EZ	60x100mm	24 / 924 m

Standaard uitvoering / Finition standard
Quick Connection: met snelkoppeling / avec connexion rapide
LIJST VAN DE TOEBEHOREN - ZIE WWW.GSV.BE
LISTE DES ACCESSOIRES - SUR WWW.GSV.BE



METALEN KANALEN CHEMINS DE CÂBLE EN METAL

Draadgoten Easy Connect - EZ
Chemins de câble Easy Connect - EZ

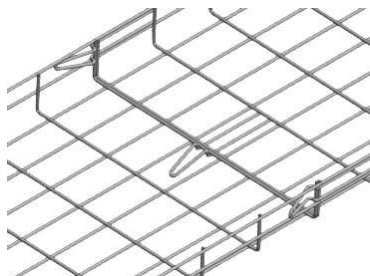



BESTELNUMMER N° DE COMMANDE	Afm. Dim.	
EC60150EZ	60x150mm	18 / 630 m
EC60200EZ	60x200mm	12/24/498 m
EC60300EZ	60x300mm	12 / 324 m
EC60400EZ	60x400mm	12 / 240 m
EC60500EZ	60x500mm	6 / 204 m
EC60600EZ	60x600mm	6 / 180 m

Standaard uitvoering / Finition standard
Quick Connection: met snelkoppeling / avec connexion rapide
LIJST VAN DE TOEBEHOREN - ZIE WWW.GSV.BE
LISTE DES ACCESSOIRES - SUR WWW.GSV.BE

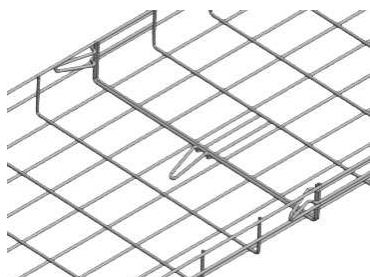

Draadgoten Easy Connect - HDG
Chemins de câble Easy Connect - HDG



BESTELNUMMER N° DE COMMANDE	Afm. Dim.	
EC60060HDG	H60 x W60 mm	24 M / 1008 M
EC60100HDG	H60 x W100 mm	24 M / 924 M
EC60150HDG	H60 x W150 mm	18M / 630 M
EC60200HDG	H60 x W200 mm	18M / 498M
EC60300HDG	H60 x W300 mm	12M / 324M
EC60400HDG	H60 x W400 mm	12M / 240M
EC60500HDG	H60 x W500 mm	6M / 204M
EC60600HDG	H60 x W600 mm	6M / 180M

Hot Dip Galva
Quick Connection: met snelkoppeling / avec connexion rapide

Draadgoten Easy Connect - Inox 304
Chemins de câble Easy Connect - Inox 304

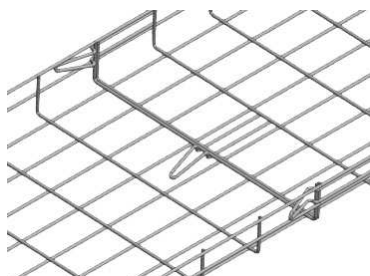

BESTELNUMMER N° DE COMMANDE	Afm. Dim.	
EC60060IN	H60 x W60 mm	24 M / 1008 M
EC60100IN	H60 x W100 mm	24 M / 924 M
EC60150IN	H60 x W150 mm	18M/ 630 M
EC60200IN	H60 x W200 mm	18M / 498M
EC60300IN	H60 x W300 mm	12M / 324M
EC60400IN	H60 x W400 mm	12M / 240M
EC60500IN	H60 x W500 mm	6M / 204M
EC60600IN	H60 x W600 mm	6M / 180M

Inox 304
Quick Connection: met snelkoppeling / avec connexion rapide

METALEN KANALEN CHEMINS DE CÂBLE EN METAL

C - Beugel voor plafond
Fixation en C pour plafond



BESTELNUMMER N° DE COMMANDE	Afm. Dim.	
SOPC10SG	180x115x215mm	8
SOPC15SG	180x115x265mm	8
SOPC20SG	180x115x315mm	8
SOPC30SG	180x115x415mm	8



L - beugel voor Wand
Fixation en L Murale

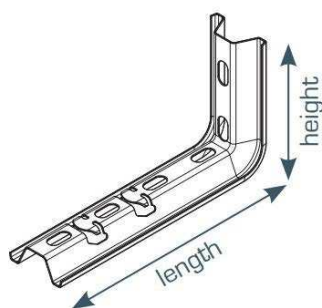

BESTELNUMMER N° DE COMMANDE	Afm. Dim.	
SOC10SG	115x215mm	10
SOC15SG	115x265mm	10
SOC20SG	115x315mm	10
SOC30SG	115x415mm	10



Snel Verbinder
Connecteur Rapide

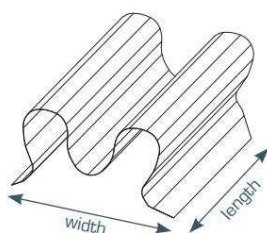

BESTELNUMMER N° DE COMMANDE	Afm. Dim.	
MCLIC390SZ	13x23mm	100

Index

0

010TARM016 36
010TARM020 36
010TARM025 36
010TARM032 36
010TARM040 36
010TARM050 36
010TARM063 36
020CARM016 36
020CARM020 36
020CARM025 36
020CARM032 36
020CARM040 36
020CARM050 36
020CARM063 36
020MARM016 37
020MARM020 37
020MARM025 37
020MARM032 37
020MARM040 37
020MARM050 37
020MARM063 37
031G 49
031T 49
040CDTM254 19
040CDTM255 19
040CDTM256 19
040CDTM257 19
040CDTM258 19
060TARMi20 36
060TARMi25 36
060TARMi32 36
060TARMi40 36
060TARMi50 36
061CARMi20 37
061CARMi25 37
061CARMi32 37
061CARMi40 37
061CARMi50 37
061MACMI20 37
061MACMI25 37
061MACMI32 37
061MACMI40 37
061MACMI50 37

1

10012 73
108 48
11405 135
11410 135
11415 135
11420 135
11425 135
11430 135
11605 135
11610 135
11615 135
11620 135
11625 135
11630 135

2

2012 78
2014 78
2016 78
2035 48
2036 48
2036 Black ... 39
2036D 49
2037 48
2037 Black ... 39
2037D 49

2

2038 48
2039 48
204 48
204 Black 39
204 White 39
20436 50
2047 54
2048 54
204D 49
2050 54
2051 54
208 48
208 Black 39
209 48
20BLI 103
210 48
211 48
211D 49
219B 12
220A 11
220AM 11
220B 12
222A 11
222AM 11
222B 12
223A 11
223AM 11
223ATA 11
223ATAM 11
223B 12
223BTA 12
223LTATR 14
224A 11
224AM 11
224B 12
224LTR 14
226B 12
242MF 14, 15
242MFTR 15
250001 72
250002 72
250005 72
250-11AM 26
250-5AM 26
250-9AM 26
250-9B 27
251001 72
251001C 72
251002 72
251002C 72
273MF 27
28.41 14
28.43 14
28.43-PLEXI . 14
28.51 14
28.53 15
28.61 14
28.998 15
28.999 15
28481 61
28483 61

3

3004-18 67
3005-18 67
3006-18 67
300620W 68
3007-18 67
3007-18Black 40, 67
300720W 68

3

3008-20 67
3009-20 67
3010-35 67
3011-35 67
3012-35 67
3014-40 67
3016-40 67
3018-40 67
3020-40 67
305505 134
305510 134
305515 134
305520 134
305525 134
305530 134
310816 136
310820 136
310825 136
311616 136
311620 136
311625 137
316 23
318 23
350001 72
350002 72
36.81 26
37000 135
37010 135
37020 135
37030 135
37040 135
37050 135
37060 135
37070 135
37080 135
37090 135
37100 135
37110 135
37120 135
37130 135
37140 135
37150 135
37160 136
37170 136
397-3A 21
397-5 21
398-5 21
399-5 21

4

411620 69
41E 103
41G 103
41I 103
41L 103
41S 103
41T 103
424 22
426 22
428 22
429 22
430 23
430V 23
431 23
431V 23
44E 103
44G 103
44I 103
44L 103
44T 103

4

4570 78
460 138
470 138
471 138

5

501018 73
501025 73
501030 73
501040 73
50704 20
50706 20
50710 20
50716 20
50725 20
512 53
512-2 53
513 53
513-2 53
514 53
515 53
515-2 53
516 53
516-2 53
517 53
517-2 53
518 53
518-2 53
519 53
520 53
5605-16 60
5605-22 60
5605-28 60
5605-38 60
5605-50 60
5605-60 60
5720 76
5721 76
5722 76
5725 76
5726 76
5727 76

6

601620 69
601922 69
602125 69
611620 69
611922 69
612125 69
679316-1 125
679316-2 124
679316-3 124
679316-4 124
679332-1 125
679332-2 124
679332-3 124
679332-4 124
679363-5 125
679363-6 125
679363-7 124
679363-8 124
679416-1 125
679416-2 124
679416-3 124
679416-4 124
679432-1 125
679432-2 125
679432-3 124
679432-4 124
679463-5 125

Index

6

679463-6 125
679463-7 124
679463-8 124
679516-1 125
679516-2 124
679516-3 124
679516-4 124
679532-1 125
679532-2 125
679532-3 124
679532-4 124
679563-5 125
679563-6 125
679563-7 124
679563-8 124

7

700-02 67
700-05 67
700-08 67
700-08 Black 67
700-11 67
700-16 67
700-23 67
701516 55
701920 55
702-0 68
702-1 68
702-2 68
702225 55
702-2W 40
702-3 68
703235 55
710-15 54
710-30 54
745-4C LG ... 30
745-8C LG ... 30
745-CRF748 . 30
745-EPS4M .. 30
745-EPS8M .. 30
745-LAN 30
755 138

9

9004121 64
9004510 65
905 53
90507 42
90509 42
90511 42
90513 42
90516 42
90521 42
90529 42
90536 42
90548 42
905M12-DMRI 44
905M16-DMRI 44
905M20-DMRI 44
905M25-DMRI 44
906 53
90607 43
90609 43
90611 43
90613 43
90616 43
906-2 54
90621 43
90629 43
90636 43
90648 43

9

907 53
90707 43
90709 43
90711 43
90713 43
90716 43
90721 43
90729 43
90736 43
90748 43
907M12 45
907M16 45
907M20 45
907M20 Black 38
907M25 45
907M32 45
907M40 45
907M50 45
907M63 45
908 53
908M16 45
908M20 45
908M25 46
908M32 46
908M40 46
908M50 46
909M16 46
909M20 46
90HS4 73
90HSM6 73
90HSXXX 73
9100001 57
9100002 57
9100004 57
9100005 57
9100007 57
9100026 57
9100029 57
9100030 57
9100031 57
9100037 57
9100038 57
9100046 57
9100047 57
9100056 58
9100057 58
9100066 57
9100067 57
9100116 57
9100120 57
9100126 57
9100132 57
9100140 57
9100150 57
9100707 57
9100900 56
9100903 58
9200900 75
9230460 59
9316-1 123
9316-2 122
9316-3 122
9316-4 122
9332-1 123
9332-2 122
9332-3 122
9332-4 122
9401001 71
9401051 77

9

9401052 77
9416-1 123
9416-2 122
9416-3 122
9416-4 122
9421 78
9422 78
9423 78
9424 78
9432-1 123
9432-2 122
9432-3 122
9432-4 122
950418 73
9516-1 123
9516-2 122
9516-3 122
9516-4 122
9532-1 123
9532-2 122
9532-3 122
9532-4 122
960418 73
9700012 56
9700016 56
9700020 56
9700025 56
9700028 56
9700316 56
9700320 56
9700325 56
9700806 59
9700808 59
9700810 59
9700812 59
9700814 59
9700816 59
9700817 60
9700819 59
9700820 60
9700825 59
9700826 59
9700828 59
9700830 59
9700832 59
9700834 59
9700836 59
9700839 59
9700845 59
9700850 59
9700855 59
9700860 59
9700875 60
9700880 60
9700916 57
9700920 57
9700925 57
9701016 56
9701020 56
9701025 56
9702816 59
9702817 60
9702819 59
9702820 60
9702836 60
9702839 60
9702845 61
9707-ORL01 . 42
9709-ORL02 . 42

9

9711-ORL03 . 42
9713-ORL04 . 42
9716-ORL05 . 42
9721-ORL06 . 42
9729-ORL07 . 42
9736-ORL08 . 42
9748-ORL10 . 42

A

AM0301 117
AM0303 118
AM0305 118
AM0306 118
AM114SS 116
AM117 115
AM117-100 ... 115
AM117-250 ... 115
AM118 115
AM118-100 ... 115
AM118-250 ... 115
AM127 115
AM127-100 .. 115
AM128 115
AM128-100 .. 115
AM370 114
AM371 114
AM374 114
AM376 114
AM9200026 .. 115
AM9200027 .. 115
AM9200028 .. 115
AM9200029 .. 115
AM9200030 .. 115
AM9260030 .. 119
AMCC1016 .. 119
AMCC2550 .. 119
AMCC-D-101E 119
AMCC-D-255C 119
AMDS16 117
AMDS18 117
AMK0310 118
AML511 114
AML512 114
AML512-E 114
AML513 114
AML514 114
AML515 114
AMM1 114
AMM116 116
AMM116-C ... 116
AMM126 116
AMM2 114
AMMB116 116
AMS116 117
AMS116-2 117
AMS126 117
AMSB116 116
AMSB126 116
AMT116 117
AMT126 117

B

BA43-06 71
BA43-08 71
BA43-10 71
BA43-12 71
BM12 44
BM16 44
BM20 44
BM20 Black .. 40
BM20 White . 40

Index

B

BM20LA 18
 BM25 44
 BM25LA 18
 BM32 44
 BM40 44
 BM50 44
 BM63 44
 BS115 22
 BS118 22
 BS11BEU 102
 BS21BEU 102
 BS61BEU 102

C

C16VD 34
 C16VD R 34
 C20VD 34
 C20VD R 34
 C25VD 34
 C25VD R 34
 C25VDLHBLA 34
 C300B 121
 C300W 121
 C310B 120
 C310W 120
 C311B 120
 C311W 120
 C320B 121
 C320W 121
 C321B 121
 C321W 121
 C32VD 34
 C32VD R 34
 C403 120
 C404 120
 C40VD 34
 C40VD R 34
 C500 27
 C50VD 34
 C50VD R 34
 CD12-11DT .. 64
 CD12-14DT .. 64
 CD12-18DT .. 64
 CD12-24DT .. 64
 CD12-30DT .. 64
 CD12-9DT 63
 CD4-11DT 63
 CD4-14DT 64
 CD4-18DT 64
 CD4-24DT 64
 CD4-30DT 64
 CD4-9DT 63
 CD7-5-11DT . 64
 CD7-5-14DT . 64
 CD7-5-18DT . 64
 CD7-5-24DT . 64
 CD7-5-30DT . 64
 CD7-5-9DT ... 63
 CFR748 30
 CLT102110R 84
 CLT102116R 84
 CLT102129R 84
 CLT102149R 84
 CON125 100
 CON30 100
 CON70 100
 CON90 100
 CP03 113
 CP06 113
 CP08 113

C

CP10 113
 CP12 113
 CP20 113
 CPN03 113
 CPN06 113
 CPN08 113
 CPN10 113
 CPN12 113
 CPN20 113

D

D006/05 86
 D006/06 86
 D006/08 86
 D010/05 86
 D010/06 86
 D010/08 86
 D010/10 86
 D016/05 86
 D016/06 86
 D016/08 86
 D016/10 86
 D025/06 86
 D025/08 86
 D025/10 86
 D035/06 86
 D035/08 86
 D035/10 86
 D035/12 86
 D050/06 86
 D050/08 86
 D050/10 86
 D050/12 86
 D070/08 86
 D070/10 86
 D070/12 86
 D070/14 86
 D095/08 86
 D095/10 86
 D095/12 86
 D095/14 86
 D120/10 86
 D120/12 86
 D120/14 86
 D150/08 86
 D150/10 86
 D150/12 86
 D150/14 86
 D185/10 86
 D185/12 86
 D185/14 86
 D240/12 86
 D240/14 86
 D240/16 86
 DB02 87
 DB04 87
 DB06 87
 DB10 87
 DB120 87
 DB150 87
 DB16 87
 DB185 87
 DB240 87
 DB25 87
 DB35 87
 DB50 87
 DB70 87
 DB95 87
 DHC95 132
 DHCR15 132

D

DVAB1F 88
 DVAB1M 88
 DVAB2F 89
 DVAB2M 89
 DVBC 5 90
 DVBC1 88
 DVBC2 89
 DVF1/03 88
 DVF1/03.7 ... 88
 DVF1/04 88
 DVF1/05 88
 DVF1/06 88
 DVF2/03 89
 DVF2/03.7 ... 89
 DVF2/04 89
 DVF2/05 89
 DVF2/06 89
 DVF5/ 03 90
 DVF5/ 04 90
 DVF5/05 90
 DVF5/06 90
 DVF5/08 90
 DVFP O5 /6.3 90
 DVFP O5 /9.5 90
 DVFPO1/2.8F 88
 DVFPO1/4.8F 88
 DVFPO1/6.3F 88
 DVFPO2/4.8F 89
 DVFPO2/6.3F 89
 DVP 5/ 1 4 ... 90
 DVP O 5 /6 .3 90
 DVP O 5 /6 .3 90
 DVP O 5 /9 .5 90
 DVP1/09 88
 DVP1/12 88
 DVP2/09 89
 DVP2/12 89
 DVPO1/2.8F . 88
 DVPO1/4.8F . 88
 DVPO1/4.8M 88
 DVPO1/6.3F . 88
 DVPO1/6.3M 88
 DVPO2/2.8F . 89
 DVPO2/4.8F . 89
 DVPO2/6.3F . 89
 DVPO2/6.3M 89
 DVPOA1/6.3 88
 DVPOA2/6.3 89
 DVR1/03 88
 DVR1/03.7 ... 88
 DVR1/04 88
 DVR1/05 88
 DVR1/06 88
 DVR1/08 88
 DVR1/10 88
 DVR1/12 88
 DVR2/03 89
 DVR2/03.7 ... 89
 DVR2/04 89
 DVR2/05 89
 DVR2/06 89
 DVR2/08 89
 DVR2/10 89
 DVR2/12 89
 DVR5/04 90
 DVR5/05 90
 DVR5/06 90
 DVR5/08 90
 DVR5/10 90

D

DVR5/12 90

E

E10 94
 E104 95
 E11 94
 E114 95
 E12 94
 E120 78
 E124 96
 E13 93
 E134 95
 E14 94
 E144 95
 E15 94
 E154 95
 E16 93
 E164 95
 E17 94
 E174 95
 E18 94
 E184 96
 E19 94
 E194 96
 E20 93
 E22 93
 E23 93
 E24 93
 E25 93
 E26 94
 E264 95
 E27 94
 E28 94
 E30 94
 E31 94
 E32 94
 E324 96
 E33 94
 E34 94
 E344 96
 E35 94
 E354 96
 E36 94
 E364 96
 E37 94
 E374 96
 E38 94
 E39 94
 E4 93
 E40 94
 E43 94
 E44 95
 E48 94
 E5 94
 E54 95
 E6 94
 E60 60
 E64 95
 E7 94
 E74 95
 E8 93
 E84 95
 E9 94
 E90 18, 22, 59, 60,
 61, 75, 77, 140,
 142
 E94 95
 EASY02 10
 EASY04 10
 EASY08 10

Index

E

EASY12 10
EASY18 10
EC16 35
EC16 R 35
EC20 35
EC20 Black .. 38
EC20 R 35
EC20 White .. 38
EC25 35
EC25 R 35
EC60060EZ .. 140
EC60060HDG 141
EC60060IN .. 141
EC60100EZ .. 140
EC60100HDG 141
EC60100IN .. 141
EC60150EZ .. 141
EC60150HDG 141
EC60150IN .. 141
EC60200EZ .. 141
EC60200HDG 141
EC60200IN .. 141
EC60300EZ .. 141
EC60300HDG 141
EC60300IN .. 141
EC60400EZ .. 141
EC60400HDG 141
EC60400IN .. 141
EC60500EZ .. 141
EC60500HDG 141
EC60500IN .. 141
EC60600EZ .. 141
EC60600HDG 141
EC60600IN .. 141
ECICTA20HF 33
ECICTA20HF1 33
ECICTA25HF 33
ECICTA25HF1 33
ECUT 97
ED10050 95
ED10075 95
ED12575 95
ED2525 95
ED2537 95
ED2550 95
ED2575 95
ED3737 95
ED3750 95
ED3775 95
ED5050 95
ED5075 95
ED7550 95
ED7575 95
ERFE20G 33
ERFE25G 33
ETC120 98
EV100 6
EV101 6
EV102 6
EV103 6
EV104 6
EV105 6
EV201D 7
EV202D 7
EV203D 7

F

FCV12040 ... 99
FCV12060 ... 99
FE12 16

F

FE15 16
FE25 16
FE25 Black .. 41
FE25 White .. 41
FE7 16
FE7 Black 41
FH10-BRDT . 62
FH10-DT 61
FH10-ICA10D 62
FH10-ICA6DT 62
FH10-ICA8DT 62
FH15-BRDT . 62
FH15-DT 61
FH15-ICA10D 61
FH15-ICA6DT 62
FH15-ICA8DT 61
FH20-BRDT . 62
FH20-DT 61
FH20-ICA10D 61
FH20-ICA6DT 62
FH20-ICA8DT 62
FH4-BRDT ... 62
FH4-DT 61
FH4-ICA10DT 62
FH4-ICA6DT 62
FH4-ICA8DT 61
FLX10 113
FLX20 113
FLX30 113
FLX40 113
FU12-5DT ... 63
FU12-5TM6DT 62
FU12-5TM8DT 63
FU20DT 63
FU20TM6DT 62
FU20TM8DT 63
FU7DT 63
FU7TM6DT .. 62
FU7TM8DT .. 63

G

G10 91
G10BEU 92
G11 91
G12 91
G13 91
G14 91
G15 91
G16 91
G16BEU 92
G17 91
G17BEU 92
G17EK 92
G17EKBEU .. 93
G18 91
G19 91
G19BEU 92
G20BEU 102
G23 91
G23BEU 92
G24 91
G26 91
G27 91
G27BEU 92
G28 91
G30 91
G30BEU 92
G31 91
G31BEU 92
G31EK 92

G

G31EKBEU .. 93
G31KBEU 93
G32 91
G33 91
G33BEU 92
G35 91
G37 91
G38 91
G39 91
G4 91
G40 91
G40BEU 92
G40EK 92
G40EKBEU .. 93
G41BEU 102
G43 91
G44BEU 102
G45BEU 102
G48 91
G48BEU 92
G4BEU 92
G4EK 92
G5 91
G50 91
G50BEU 92
G50EK 92
G50EKBEU .. 93
G50KBEU ... 93
G6 91
G6BEU 92
G8 91
G8BEU 92
G9 91
G9BEU 92
GCOP025 98
GCOP040 98
GCOP060 98
GCOP080 98
GCOP100 98
GCOP100BEL 98
GCOP120 98
GCOP120BEL 98
GCOP150 98
GCOP150BEL 98
GCOP200 98
GCOP200BEL 98
GT16A 103
GT248AB 103
GT248EB 103
GT248GB 103
GT248IB 103
GT248LB 103
GT248TB 103
Guest05 113
Guest10 113
Guest20 113
Guest30 113
Guest50 113

H

HB0050 77
HB0060 77
HB0070 77
HB0080 77
HB0100 77
HB0120 77
HB0150 77
HB0180 77

H

HF 11, 12, 13, 14,
15, 16, 17, 18,
20, 21, 22, 23,
24, 25, 26, 27,
30, 31, 32, 33,
34, 35, 38, 39,
40, 41, 42, 43,
44, 45, 46, 47,
48, 49, 50, 51,
52, 53, 54, 55,
67, 68, 69, 79,
80, 81, 82, 83,
84, 85, 97, 104,
105, 106, 107,
108, 109, 122,
123, 124, 125,
138
HTC18S 10

I

IW10054B 108
IW10054Black 108
IW10054BLH 108
IW10054LHBL 108
IW2010 104
IW2012.5Blac 105
IW2012.5BLH 106
IW2012.5LHBl 106
IW2020LH 106
IW4017B 104
IW4017Black 105
IW4017LH 106
IW4017LHBlac 106
IW4040BLH . 106
IW6040LH 106
IWAE10054B 109
IWAE10054Bl 109
IWAE2012B . 104
IWAE2012Blac 105
IWAE4017B . 104
IWAE4017Blac 105
IWAI10054B . 109
IWAI10054Blac 109
IWAI2012B ... 104
IWAI2012Blac 105
IWAI4017B ... 104
IWAI4017Blac 105
IWAP10054B 109
IWAP10054Blac 109
IWAP2012B . 104
IWAP2012Blac 105
IWAP4017B . 104
IWAP4017Blac 105
IWGT10054B 109
IWGT10054Blac 109
IWGT2012B . 104
IWGT2012Blac 105
IWGT4017B . 104
IWGT4017Blac 105
IWGU2012B . 104
IWGU2012Blac 105
IWGU4017B . 104
IWGU4017Blac 105
IWGUB100 ... 109
IWGUB100Blac 109
IWS10040B .. 109
IWS10040Blac 109
IWTT10054B 109
IWTT10054Blac 109
IWTT2012B .. 104
IWTT2012Blac 105
IWTT4017B .. 104

Index

I

IWTT4017Blac 105
IZ10/2F/54 29
IZ10/3F/54 29
IZ16/2F/54 29
IZ16/3F/54 29
IZ16/4F/56 29
IZ16/4FN/54 . 29
IZS10/3F/54 . 29
IZS16/2F/54 . 29
IZS16/3F/54 . 29
IZS16/4F/56 . 29

J

J100B 12
J100BF 18
J100L 12
J100S 11
J100S Black . 40
J100S White . 40
J100SC 11
J100SF 18
J1207PAD 102
J1602 18
J160B 12
J160BF 18
J160L 12
J1610PAD ... 102
J200B 12
J200BF 18
J200L 12
J2021 18
J402Z 18
J80B 12
J80L 12

K

KCP00S 10
KP64-50-2LD 22
KP64-50-3LD 22
KP64-50-4LD 22
KP64-50-5LD 22
KP64-50LD ... 22
KP64-60LD ... 22
KPZ1PO 22
KT3001 133, 134
KT3002-3204 133
KT3002-3704 134
KT3204 133
KT3604 134
KT3704 133
KTA00S 10

L

LD075ABEU . 112
LD075EBEU . 111
LD075IBEU .. 111
LD075LBEU . 112
LD075TBEU . 112
LD105EBEU . 111
LD105LBEU . 112
LD105TBEU . 112
LD125A 111
LD125EBEU . 111
LD125IBEU .. 111
LD125LBEU . 112
LD125TBEU . 112
LDJ01 6
LHD2010HF . 106
LHD2020HF . 106
LHD4020HF . 106
LHD4040HF . 106

L

LHD8623HF . 107
LHD8624HF . 107, 112
LHD8625HF . 107
LHD8626HF . 107
LHD8633HF . 107
LHD8634HF . 107, 112
LHD8635HF . 107
LHD8636HF . 107
LHD8643HF . 107
LHD8644HF . 107, 112
LHD8645HF . 107
LHD8646HF . 107
LHD8923HF . 107
LHD8924HF . 107, 112
LHD8925HF . 107
LHD8926HF . 107
LOCKCM 24
LOCKDM 25

M

M001CS 17
M002CS 17
M003CS 17
M005CS 17
MCLIC390SZ 142
ME1216 46
ME1620 46
ME2025 46
ME2532 46
ME3240 46
MET22102R . 83
MET22105R . 83
MET22110R . 83
MET22111R . 83
MET22112R . 83
MET22123R . 83
MET22126R . 83
MET22140R . 83
MET22534R . 83
MET32102R . 83
MET32105R . 83
MET32110R . 83
MET32111R . 83
MET32112R . 83
MET32123R . 83
MET32126R . 83
MET32140R . 83
MET32326R . 83
MET32534R . 84
MF003 9
MF111 84
MF112 84
MF1604 7
MFBOX01 127
MFM46 126
MFPS17 126
MFR253G25 . 126
MFR403G25 . 126
MFVS10 126
MFVS15 126
MFVS20 126
MFVS25 126
MFVS30 126
MFVS40 126
MFVS50 126
MIB16 13
MIB21 13
MIB29 13
MIBR1620 35
MIBR1620 Bla 39

M

MIBR1620 Wf 39
MJB112 6
MJB113 6
MJB215 6
MJB222 6
MJB332 6
MP0030 3
MP0100 3
MP1000 3
MP103 3
MP106 3
MP109 3
MP2200 3
MPONE GEL 4
MR1612 47
MR2012 47
MR2016 47
MR2512 47
MR2516 47
MR2520 47
MR3212 47
MR3216 47
MR3220 47
MR3225 47
MR4016 47
MR4020 47
MR4025 47
MR4032 47
MR5020 47
MR5025 47
MR5032 47
MR5040 47
MR6325 47
MR6332 47
MR6340 47
MR6350 47
MT60100075 140
MT60200075 140
MT60300075 140
MT6075075 .. 140
MTCTS100 ... 140
MTCTS200 ... 140
MTCTS300 ... 140
MTLTS100 ... 140
MTLTS150 ... 140
MTLTS200 ... 140
MTLTS300 ... 140

N

N-12 28
N12-C 24
N12-D 25
N-15 28
N18-C 24
N18-D 25
N24-C 24
N24-D 25
N2x18-C 24
N36-C 24
N36-D 25
N3x18-C 24
N48-C 24
N48-D 25
N4-C 24
N4-D 25
N4x18-C 24
N6-D 25
N-7 28
N8-C 24
N8-D 25

N

NEW 3, 7, 10, 50, 51,
52, 118, 135
NSET-C-D 26
NVIS-C-D 25

O

OL70211 68
OL70212 68
OL70213 68
OL70214 68
OL70215 68
OL70216 68
OL70217 68
OL70218 68
OMRL05A7 .. 44

P

P1ES 71
P2ES 71
P3ES 71
PC0015 139
PC0018 139
PC0022 139
PC0028 139
PC0035 139
PC0042 139
PC0048 139
PC0054 139
PC0060 139
PC0064 139
PC0090 139
PC0110 139
PC1075 139
PC1100 139
PC1115 139
PC1125 139
PC1133 139
PC1140 139
PC1150 139
PC1160 139
PD15ZF4 75
PD32ZF6 75
PD35CZ 75
PD35CZF6 ... 75
PD35Z 75
PD35ZF6 75
PDTR2M 75
PE-12 28
PE-15 28
PE-7 28
PICSHARK68I 5
PICSHARK68I 5
PICSHARK68I 5
PICSHARK68I 5
PICSHARK68I 5
PICSHARK68I 5
PIN003-CTTN 83
PIN005 82
PIN006-CTTS 83
PM12 45
PM16 45
PM20 45
PM25 45
PM32 45
PM40 45
PM50 45
PM63 45
PRRIV1 96
PRRIV2 96
PST-5 51
PST-7 51

Index

P

PSTB-4 51
 PSTB-7 51
 PTR 96

R

RH18S 26
 RH36/2S 26
 RH54/3S 26
 RH72/4S 26
 RIV1 96
 RIV2 96
 RS150 4
 RS1650 4
 RS300 4
 RS400 4
 RS550 4
 RS650 4

S

S1 99
 S2 99
 SAE160BEU .. 111
 SAI160BEU .. 107, 111
 SAP160BEU .. 112
 SB17-11DT ... 63
 SCO45 110
 SDK3 20
 SDK5 20
 SDK8 20
 SDKF2TR-AN 20
 SDKF3TR-AN 20
 SDKF5TR-AN 20
 SEL.2.202T .. 81
 SEL101 85
 SEL10202R .. 81
 SEL10210R .. 81
 SEL10223R .. 81
 SEL10425R .. 81
 SEL11202R .. 81
 SEL11210R .. 81
 SEL11223R .. 81
 SEL11425R .. 81
 SEL12202R .. 81
 SEL12210R .. 81
 SEL12223R .. 81
 SEL12425R .. 81
 SEL14202R .. 81
 SEL14210R .. 81
 SEL14223R .. 81
 SEL14425R .. 81
 SEL2142 80
 SEL2143 80
 SEL2144 80
 SEL2155 80
 SEL2201 80
 SEL2202 80
 SEL2203 80
 SEL2204 80
 SEL2205 80
 SEL2210 80
 SEL2211 80
 SEL2212 80
 SEL2214 80
 SEL2216 80
 SEL2220 80
 SEL2221 80
 SEL2222 80
 SEL2223 80
 SEL2224 80
 SEL2401 85
 SEL2402 85

S

SEL2403 85
 SEL2425 80
 SEL2426 80
 SEL2427 80
 SEL2428 80
 SEL2429 80
 SEL2430 80
 SEL2431 80
 SEL2432 80
 SEL2433 80
 SEL2434 80
 SEL2435 79, 80
 SEL2436 80
 SEL2438 80
 SEL2441 80
 SEL2447 80
 SEL2450 80
 SEL2451 80
 SEL2452 80
 SEL2453 80
 SEL2501 85
 SEL2502 85
 SEL3142 79
 SEL3143 79
 SEL3144 79
 SEL3150 79
 SEL3155 79
 SEL3201 79
 SEL3202 79
 SEL3203 79
 SEL3204 79
 SEL3205 79
 SEL3210 79
 SEL3211 79
 SEL3212 79
 SEL3214 79
 SEL3215 80
 SEL3216 79
 SEL3220 79
 SEL3221 79
 SEL3222 79
 SEL3223 79
 SEL3224 79
 SEL3320 82
 SEL3321 82
 SEL3322 82
 SEL3323 82
 SEL3324 82
 SEL3425 79
 SEL3426 79
 SEL3427 79
 SEL3428 79
 SEL3429 79
 SEL3430 79
 SEL3431 79
 SEL3432 79
 SEL3433 79
 SEL3434 79
 SEL3436 79
 SEL3437 80
 SEL3438 79
 SEL3441 79
 SEL3447 79
 SEL3451 79
 SEL3452 79
 SEL3453 79
 SEL712006 .. 69
 SEL712008 .. 69
 SEL712010 .. 69

S

SEL712012 .. 69
 SELCGO101 70
 SELCXP102 . 70
 SELCXP104 . 70
 SELCXP106 . 70
 SELPXV101 . 70
 SELRXO101 . 70
 SELRXO102 . 70
 SGACBEU ... 110
 SGC0BEU ... 111
 SHARK150 ... 4
 SHARK306 ... 4
 SHARK325 ... 4
 SHARK506 ... 4
 SHARK506W 5
 SHARK516 ... 4
 SHARK516Y 5
 SHARK525W 5
 SHARK6801A 5
 SHARK6801B 5
 SHARK6801C 5
 SHARK6801D 5
 SHARK6802A 5
 SHARK6803A 5
 SOC10SG 142
 SOC15SG 142
 SOC20SG 142
 SOC30SG 142
 SOPC10SG .. 142
 SOPC15SG .. 142
 SOPC20SG .. 142
 SOPC30SG .. 142
 Spirado 136
 Spiratrek 136
 SSCT1 82
 SSCT2 82
 SSCT3 82
 SSCT4 82
 SSCT5 82
 SSCT6 82
 SSCT7 82
 ST16 50
 ST20 50
 ST25 50
 ST32 50
 ST40 50
 ST-BASE 52
 STC16 50
 STC20 50
 STC25 50
 STC32 50
 STC40 50
 ST-CLIP 51
 STT125BEU . 112
 STT160BEU . 112
 SYS10051 110
 SYS1252 110
 SYS1603 110
 SYS751 110

T

TC57 74
 TCGUN 74
 TP151920BK 66
 TP151920BL 66
 TP151920BN 66
 TP151920GR 66
 TP151920GR 66
 TP151920GY 66
 TP151920RD 66

T

TP151920WT 66
 TP151920YL 66
 TP155020RD 66
 TP155020YL 66
 TPQSM32 27
 TR06 96
 TR08 96
 TR10 96
 TR10006 76
 TR10006INA2 76
 TR10006INA4 76
 TR10008 76
 TR10008INA2 76
 TR10008INA4 76
 TR10010 76
 TR10010INA2 76
 TR10012 76
 TR10012INA2 76
 TR20006 76
 TR20006INA2 76
 TR20008 76
 TR20008INA2 76
 TR20010 76
 TR20012 76
 TR30006 76
 TR30008 76
 TR30010 76
 TR30012 76

U

U12-C 24
 U18-C 24
 U24-C 24
 U2x18-C 24
 U36-C 24
 U3x18-C 24
 U407 33
 U407 R 34
 U408 33
 U408 Black .. 39
 U408 R 34
 U408 White .. 39
 U409 33
 U409 Black .. 39
 U409 R 34
 U410 34
 U410 R 34
 U411 34
 U411 R 34
 U412 34
 U412 R 34
 U413R 34
 U4-C 24
 U8-C 24

V

V6H100100 .. 97
 V6H10060 97
 V6H10080 97
 V6H2525 97
 V6H4025 97
 V6H4040 97
 V6H4060 97
 V6H4080 97
 V6H60100 97
 V6H60120 97
 V6H6025 97
 V6H6040 97
 V6H6060 97
 V6H6080 97
 V6H80100 97

Index

V

V6H80120 97
V6H8025 97
V6H8040 97
V6H8060 97
V6H8080 97
VD16 31
VD16 FLH 32
VD16 LLH 31
VD16 MLH 32
VD16 R 31
VD16 R-2M .. 31
VD16-2M 31
VD16R-1.5M 31
VD20 31
VD20 Black .. 38
VD20 Black-2l 38
VD20 FLH 32
VD20 LLH 32
VD20 LLHBLA 32, 38
VD20 MLH 32
VD20 R 31
VD20 R-2M .. 31
VD20 White .. 38
VD20 White-2l 38
VD20-2M 31
VD20HFPPMC 33
VD20R-1.5 ... 31
VD25 31
VD25 LH 32
VD25 LLH 32
VD25 LLHBLA 32, 38
VD25 R 31
VD25HPPMC 33
VD25R-1.5M 31
VD32 31
VD32 LH 32
VD32 LLH 32
VD32 R 31
VD32R-1.5M 31
VD40 31
VD40 LH 32
VD40 R 31
VD50 31
VD50 LH 32
VD50 R 31
VD63 LH 32
VD63R 31

W

W10 129
W10.1 129
W100 130
W1000 128
W16 130
W25 131
W30 130
W300 131
W400 131
W4-16 128
W50 128
W500 132
W8-27 128
WAB05200 ... 98
WBLI13 130
WBLI28H4 ... 129
WBLI3SOLAR 132
WBLI5 131
WBLI7SOLAR 132
WBLIS428 129

Z

Z102F 29
Z103F 29
Z162F 29
Z163F 29
Z164F 29
ZBFB 101
ZBFG 101
ZS102F 29
ZS103F 29
ZS162F 29
ZS163F 29
ZS164F 29

WWW.GSV.BE



#GSV-WEB



#GSV

**TERBEKEHOFDREEF 51
2610 WILRIJK**

**T: 03 326 50 77
F: 03 326 49 23**

**WWW.GSV.BE
E: OFFICE@GSV.BE**

**BTW/TVA BE 0427.142.369
HRA/RCA 245.824**

09/2023



SINDS – DEPUIS 1985

**WIJ BEVESTIGEN UW TOEKOMST
UNE ATTACHE POUR VOTRE AVENIR**